

# WALLEY XP 6

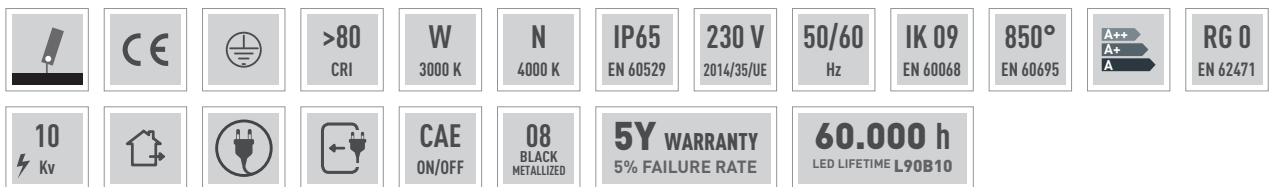

## EN

Extruded anodized aluminum body with heat-sink function. Bent steel adjustable bracket and frame painted with epoxy powders after phosphating complete with goniometer. Direct light emission. Street optics in high performance optical molded silicone with high mechanical resistance, anti-yellowing and anti-scratch. LED light source. IP66 quick plug-in connector for power line included. High frequency (CAE) ballast in separate IP65 box fixed to the body.

## ES

Cuerpo en aluminio extruido anodizado con función de disipador. Marco y soporte regulable de acero plegado a presión barnizado con polvo epoxi previamente fosfatado, completo de goniómetro. Emisión directa. Óptica vial en silicona estampada de alto rendimiento con alta resistencia mecánica, anti-amarilleo y anti-rayado. Fuente de luz LED. Conector rápido IP66 para alimentación incluido. Alimentación electrónica CAE externa, IP65 fijada al cuerpo.

## IT

Corpo in alluminio estruso anodizzato con funzione di dissipatore. Telaio e staffa regolabile in acciaio pressopiegato verniciati con polveri epossidiche previa fosfatazione, completa di goniometro. Ottiche stradali in silicone stampato ad alto rendimento ottico con elevata resistenza meccanica, anti-ingiallimento ed antigraffio. Emissione diretta. Sorgente luminosa LED. Connettore rapido IP66 per linea di alimentazione incluso. Alimentazione elettronica CAE esterna, IP65 fissata al corpo.

## DE

Körper aus eloxiertem extrudiertem Aluminium mit Kühlkörperfunktion. Rahmen und verstellbare Halterung aus gepresstem Stahl, der nach der Phosphatierung mit Epoxidpulver lackiert wurde, komplett mit Goniometer. Straßenoptik aus optisch geformtem Hochleistungssilikon mit hoher mechanischer Beständigkeit, Vergilbungs- und Kratzfestigkeit. Direkte Lichtemission. LED-Lichtquelle. Direkte Ausgabe. IP66-Schnellverbinder für Stromleitung enthalten. Externe elektronische Stromversorgung, IP65 am Gehäuse befestigt.

## FR

Corps en aluminium extrudé et anodisé avec fonction de dissipateur. Support de fixation réglable, pliée à la presse, en acier traité avec peinture epoxy pulvérisé par phosphatation. Émission directe. Optiques routières encapsulées dans le silicone moulé offrant une haute transparence optique, résistance mécanique élevée, et un fort indice de réfraction. Forte résistance aux UVs, aux chocs et aux rayures. Source lumineuse LED. Connecteur rapide IP66 pour ligne électrique incluse. Alimentation électronique CAE externe IP65 fixée au corps.

## RU

Анодированный экструдированный алюминиевый корпус с функцией радиатора. Регулируемая рама и кронштейн из гнутой фосфатированной стали, окрашенные эпоксидными красками-порошками, в комплекте с транспортом. Уличная оптика из высокоэффективного оптического литого силикона с высокой механической прочностью, устойчивого к пожелтению и царапинам. Прямой поток света. Светодиодный источник света. Быстроразъемное соединение IP66 для линии электроподключения включено в комплект. Внешний электронный блок питания CAE, IP65 закреплен на корпусе.

## WALLEY XP 6 AS



Code	Lm LED	Lm Out	Watt Out	Lm Watt Out	Relamping
<b>KWYX64013ASW/N08</b>	47160	33930	300	> 113	600
<b>KWYX64016ASW/N08</b>	55500	39900	369	> 108	600
<b>KWYX66013ASW/N08</b>	68520	48690	441	> 110	1000
<b>KWYX66016ASW/N08</b>	83040	59745	573	> 104	1000
<b>KWYX68016ASW/N08</b>	84600	61275	552	> 111	1000
<b>KWYX68018ASW/N08</b>	93600	66210	606	> 109	1000
<b>KWYX68021ASW/N08</b>	106200	76755	732	> 105	1500

W/N= **W** (3000 K) | **N** (4000 K)

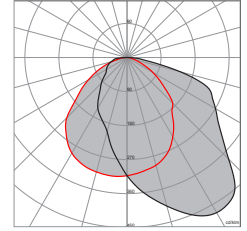

Lm Led/Lm Out:  
Standard - **N** (4000 K)  
-8% - **W** (3000 K)

## WALLEY XP 6 AS2



Code	Lm LED	Lm Out	Watt Out	Lm Watt Out	Relamping
<b>KWYX64013AS2W/N08</b>	47160	32625	300	> 109	600
<b>KWYX64016AS2W/N08</b>	55500	38400	369	> 105	600
<b>KWYX66013AS2W/N08</b>	68520	46830	441	> 106	1000
<b>KWYX66016AS2W/N08</b>	83040	57450	573	> 100	1000
<b>KWYX68016AS2W/N08</b>	84600	58920	552	> 106	1000
<b>KWYX68018AS2W/N08</b>	93600	63660	606	> 105	1000
<b>KWYX68021AS2W/N08</b>	106200	72870	732	> 100	1500

W/N= **W** (3000 K) | **N** (4000 K)

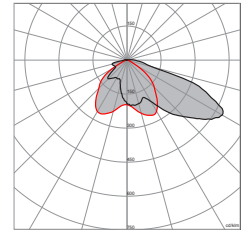

Lm Led/Lm Out:  
Standard - **N** (4000 K)  
-8% - **W** (3000 K)

## WALLEY XP 6 D



Code	Lm LED	Lm Out	Watt Out	Lm Watt Out	Relamping
<b>KWYX64013DW/N08</b>	47160	35250	300	> 118	600
<b>KWYX64016DW/N08</b>	55500	41460	369	> 112	600
<b>KWYX66013DW/N08</b>	68520	50550	441	> 115	1000
<b>KWYX66016DW/N08</b>	83040	62040	573	> 108	1000
<b>KWYX68016DW/N08</b>	84600	63630	552	> 115	1000
<b>KWYX68018DW/N08</b>	93600	68760	606	> 114	1000
<b>KWYX68021DW/N08</b>	106200	78690	732	> 108	1500

W/N= **W** (3000 K) | **N** (4000 K)

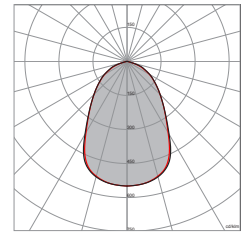

Lm Led/Lm Out:  
Standard - **N** (4000 K)  
-8% - **W** (3000 K)

## WALLEY XP 6 C



Code	Lm LED	Lm Out	Watt Out	Lm Watt Out	Relamping
<b>KWYX64013CW/N08</b>	47160	34365	300	> 114,6	600
<b>KWYX64016CW/N08</b>	55500	40425	369	> 109,6	600
<b>KWYX66013CW/N08</b>	68520	49320	441	> 111,8	1000
<b>KWYX66016CW/N08</b>	83040	60510	573	> 105,6	1000
<b>KWYX68016CW/N08</b>	84600	62070	552	> 112,4	1000
<b>KWYX68018CW/N08</b>	93600	67050	606	> 110,6	1000
<b>KWYX68021CW/N08</b>	106200	76650	732	> 104,7	1500

W/N= **W** (3000 K) | **N** (4000 K)

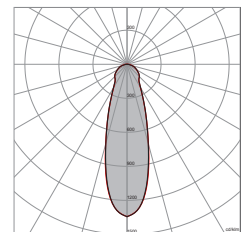

Lm Led/Lm Out:  
Standard - **N** (4000 K)  
-8% - **W** (3000 K)



Code

Code Ordering example: **KWYX64013 AS W/N 08**

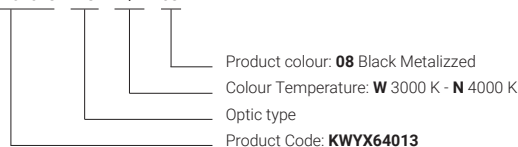

WALLEY XP

DIMENSIONAL + FIXTING

WALLEY XP 6

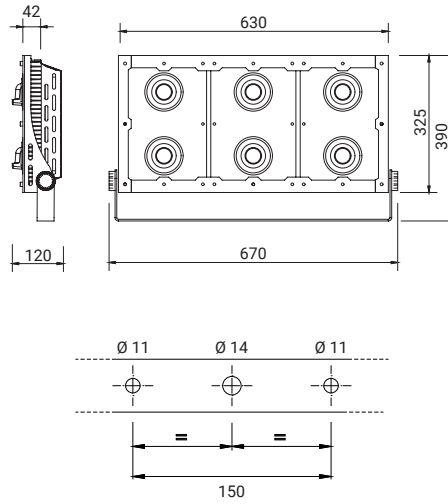

WIND RESISTANCE

WALLEY XP 6

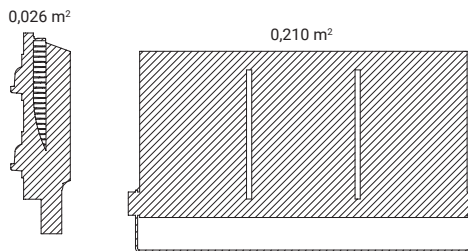

WEIGHT (Kg)

**15,0**

MINIMUM AND MAXIMUM ENVIRONMENT TEMPERATURE (Ta)

**-20 ~ +45°C**