

# MOKA XL

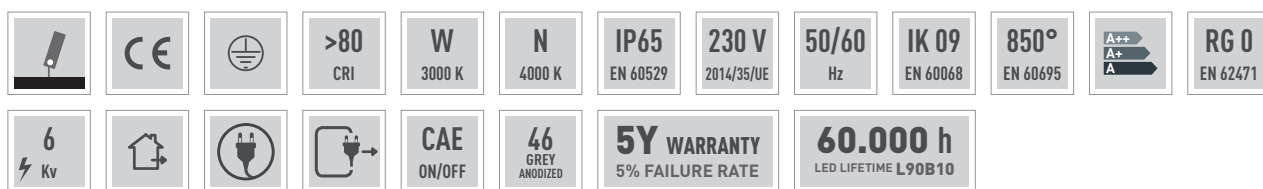

## EN

Extruded anodized aluminum body with heat-sink function. Bent anodized aluminum frame painted with epoxy powders after phosphating. IP 65 printed silicon optical unit. Bent steel adjustable bracket painted with epoxy powders after phosphating complete with goniometer. Street optics in high performance optical molded silicone with high mechanical resistance, anti-yellowing and anti-scratch. LED light source. Direct light emission. IP66 quick plug-in connector for power line included. High frequency (CAE) ballast in separate IP65 box fixed to the body.

## ES

Cuerpo en aluminio extruido anodizado con función de disipador. Marco en aluminio anodizado plegado a presión con polvo epoxi previamente fosfatado. Grupo óptico en silicona impresa IP65D. Soporte regulable en acero plegado a presión y recubierto con polvo epoxi previamente fosfatado, completo de goniómetro. Óptica vial en silicona estampada de alto rendimiento con alta resistencia mecánica, anti-amarilleo y anti-rayado. Fuente de luz LED. Emisión directa. Conector rápido IP66 para alimentación incluido. Alimentación electrónica CAE externa, IP65 fijada al cuerpo.

## IT

Corpo in alluminio estruso anodizzato con funzione di dissipatore. Telaio in alluminio pressopiegato verniciato con polveri epossidiche. Gruppo ottico in silicone stampato IP65. Staffa regolabile in acciaio pressopiegato verniciata con polveri epossidiche previa fosfatazione, completa di goniometro. Ottiche stradali in silicone stampato ad alto rendimento ottico con elevata resistenza meccanica, anti-ingiallimento ed antigraffio. Sorgente luminosa LED. Emissione diretta. Connettore rapido IP66 per linea di alimentazione incluso. Alimentazione elettronica CAE esterna, IP65 fissata al corpo.

## DE

Körper aus eloxiertem extrudiertem Aluminium mit Kühlkörperfunktion. Anodisierter, gepresster Aluminiumrahmen der nach der Phosphatierung mit Epoxidpulver lackiert wurde. Optische Einheit aus gegossenem Silikon IP65. Verstellbare Halterung aus gepresstem Stahl, der nach der Phosphatierung mit Epoxidpulver lackiert wurde, komplett mit Goniometer. Straßenoptik aus optisch geformtem Hochleistungssilikon mit hoher mechanischer Beständigkeit, Vergilbungs- und Kratzfestigkeit. LED-Lichtquelle. Direkte Ausgabe. IP66-Schnellverbinder für Stromleitung enthalten. Externe elektronische Stromversorgung, IP65 am Gehäuse befestigt.

## FR

Corps en aluminium extrudé et anodisé avec fonction de dissipateur. Châssis en aluminium anodisé pliée à la presse peint avec peinture epoxy poudré après phosphatation. Groupe optique en silicone imprimé IP65. Support de fixation réglable en acier pliée à la presse et peint avec peinture epoxy poudré après phosphatation avec goniomètre. Optiques routières encapsulées dans le silicone moulé offrant une haute transparence optique, résistance mécanique élevée, et un fort indice de réfraction. Forte résistance aux UVs, aux chocs et aux rayures. Source lumineux LED. Émission directe. Connecteur rapide IP66 pour ligne électrique incluse. Alimentation électronique CAE externe IP65 fixée au corps.

## RU

Анодированный экструдированный алюминиевый корпус с функцией теплоотвода. Анодированная, штампованная алюминиевая рама. Оптический блок из литого силикона со степенью защиты IP65. Регулируемый кронштейн из штампованной стали, окрашенный эпоксидными порошковыми красками после фосфатирования, в комплекте с транспортиром. Уличная оптика из высокоэффективного оптического литого силикона с высокой механической прочностью, устойчивого к пожелтению и царапинам. Светодиодный источник света. Прямой поток света. Быстроразъемное соединение IP66 для линии электроподключения включено в комплект. Внешний электронный блок питания CAE, IP65 закреплен на корпусе.

## MOKA XL AS



Code	Lm LED	Lm Out	Watt Out	Lm Watt Out	Relamping
<b>KMK46014ASW/N46</b>	48600	35020	324	> 108	600
<b>KMK46017ASW/N46</b>	58000	41300	400	> 103	600
<b>KMK48018ASW/N46</b>	62400	46700	408	> 115	1000
<b>KMK48022ASW/N46</b>	73200	53200	508	> 105	1000

W/N= W (3000 K) | N (4000 K)

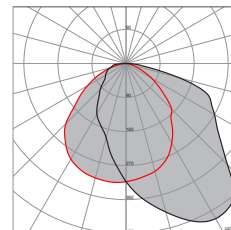

Lm Led/Lm Out:  
Standard - N (4000 K)  
-8% - W (3000 K)

## MOKA XL AS2



Code	Lm LED	Lm Out	Watt Out	Lm Watt Out	Relamping
<b>KMK46014AS2W/N46</b>	48600	37120	324	> 115	600
<b>KMK46017AS2W/N46</b>	58000	43740	400	> 109	600
<b>KMK48018AS2W/N46</b>	62400	47305	408	> 116	1000
<b>KMK48022AS2W/N46</b>	73200	56400	508	> 111	1000

W/N= W (3000 K) | N (4000 K)

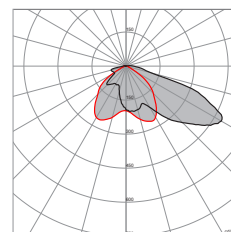

Lm Led/Lm Out:  
Standard - N (4000 K)  
-8% - W (3000 K)

## MOKA XL D



Code	Lm LED	Lm Out	Watt Out	Lm Watt Out	Relamping
<b>KMK46014DW/N46</b>	48600	37580	324	> 116	600
<b>KMK46017DW/N46</b>	58000	44300	400	> 111	600
<b>KMK48018DW/N46</b>	62400	47900	408	> 118	1000
<b>KMK48022DW/N46</b>	73200	57080	508	> 112	1000

W/N= W (3000 K) | N (4000 K)

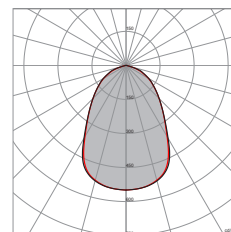

Lm Led/Lm Out:  
Standard - N (4000 K)  
-8% - W (3000 K)

## MOKA XL C



Code	Lm LED	Lm Out	Watt Out	Lm Watt Out	Relamping
<b>KMK46014CW/N46</b>	48600	36320	324	> 112	600
<b>KMK46017CW/N46</b>	58000	42780	400	> 107	600
<b>KMK48018CW/N46</b>	62400	46300	408	> 114	1000
<b>KMK48022CW/N46</b>	73200	55160	508	> 109	1000

W/N= W (3000 K) | N (4000 K)

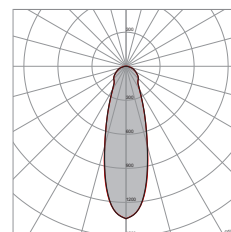

Lm Led/Lm Out:  
Standard - N (4000 K)  
-8% - W (3000 K)



Code

Code Ordering example: **KMK46014 AS W/N 46**

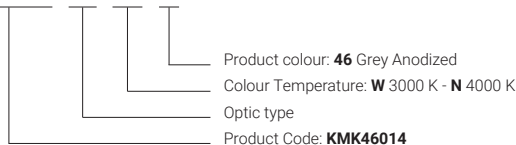

MOKA XL

DIMENSIONAL + FIXTING

MOKA XL

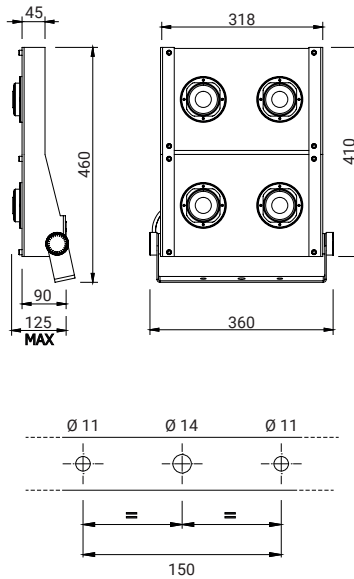

WIND RESISTANCE

MOKA XL

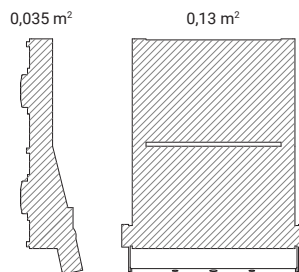

WEIGHT (Kg)

**9,7**

MINIMUM AND MAXIMUM ENVIRONMENT TEMPERATURE (Ta)

**-20 ~ +45°C**

 Application (Tennis Court)



Playground Area	Poles	Lux Value Result	Light Fittings Required
23,8x10,8 m	4 x h= 8 m	165 Lx	no.8 KMK26014AS2N
23,8x10,8 m	4 x h= 8 m	200 Lx	no.8 KMK26017AS2N
23,8x10,8 m	4 x h= 8 m	250 Lx	no.8 KMK28022AS2N

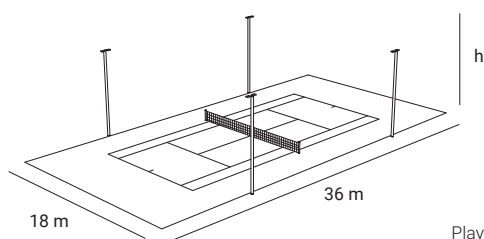

Playground Area	Poles	Lux Value Result	Light Fittings Required
23,8x10,8 m	6 x h= 8 m	300 Lx	n.12 KMK26017AS2N
23,8x10,8 m	6 x h= 10 m	500 Lx	n.12 KMK46017AS2N

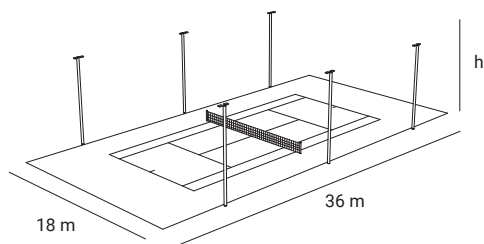

Playground Area	Lines	Lux Value Result	Light Fittings Required
23,8x10,8 m	2x5 pezzi x h= 7,5 m	300 Lx	n.10 KMK26017AS2N

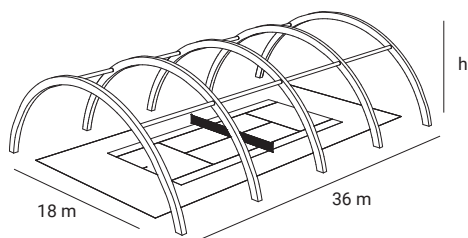

Norm	Activity	Illuminance Required
-	Not Competitive	<200 Lx
Coni CN 1379-2008	Competitive Level 1	200 Lx
Coni CN 1379-2008	Competitive Level 2	300 Lx
Coni CN 1379-2008	Competitive Level 3	500 Lx

 Application (Futsal)



Playground Area	Poles	Lux Value Result	Light Fittings Required
42x22 m	4 x h= 9 m	100 Lx	n.8 KMK26017AS2N
42x22 m	4 x h= 9 m	200 Lx	n.8 KMK46017AS2N

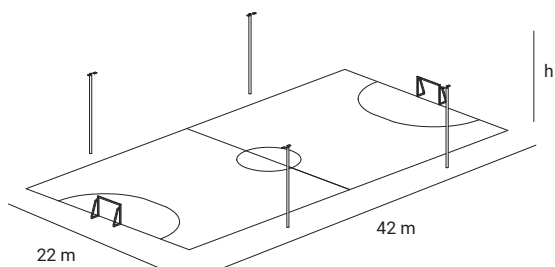

Playground Area	Poles	Lux Value Result	Light Fittings Required
42x22 m	6 x h= 10 m	130 Lx	n.12 KMK26017AS2N
42x22 m	6 x h= 10 m	250 Lx	n.12 KMK46017AS2N

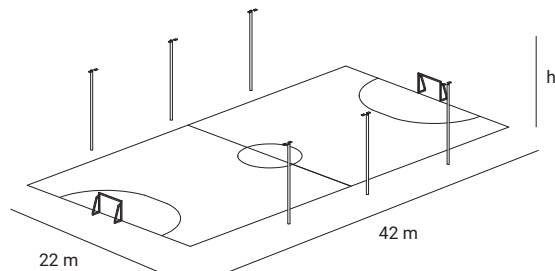

Norm	Activity	Light Fittings Required
-	Not Competitive	<100 Lx
Coni CN 1379-2008	Competitive Level 1	100 Lx
Coni CN 1379-2008	Competitive Level 2	200 Lx
Coni CN 1379-2008	Competitive Level 3	500 Lx

 Application (Parking)

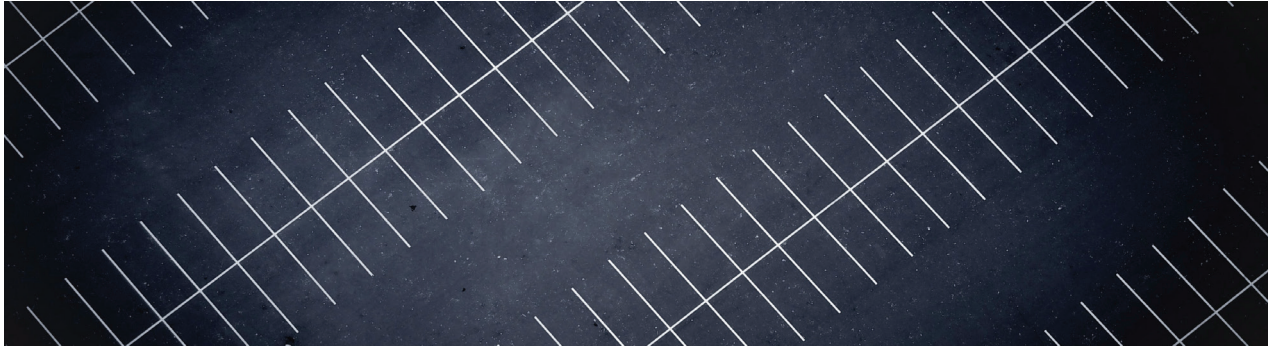

Parking Area	Poles	Lux Value Result	Light Fittings Required
33x38 m	1 x h= 8 m	5 Lx	n.1 KMK26014AS2N

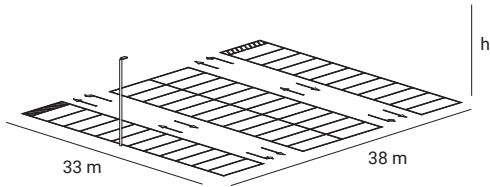

Parking Area	Poles	Lux Value Result	Light Fittings Required
33x38 m	2 x h= 8 m	10 Lx	n.2 KMK26014AS2N

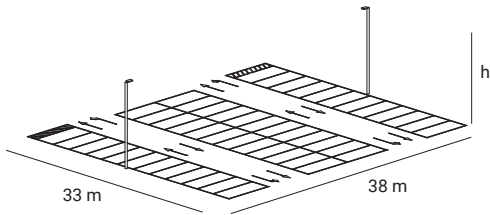

Parking Area	Poles	Lux Value Result	Light Fittings Required
33x38 m	1 x h= 15 m	20 Lx	n.4 KMK26014AS2N

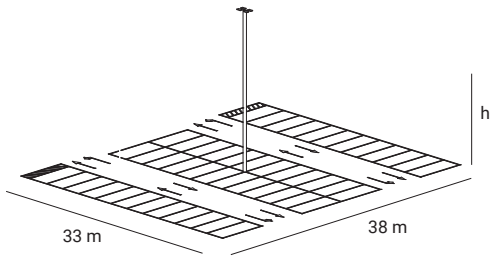

Norm	Activity	Light Fittings Required
UNI EN12464	Light Traffic	5 Lx
UNI EN12464	Medium Traffic	10 Lx
UNI EN12464	Heavy Traffic	20 Lx