

*Lookup*



30 anni di produzione, ricerca e sviluppo  
dedicati al nostro magnifico progetto  
l'evoluzione della luce.



# INDEX

## GENERAL INDEX

- 5 Illustrated Index (Suspension, Wall)
- 7 Illustrated Index (Pedestal, Recessed, Table Lamp, Track Lights)
- 9 Who we are
- 9 Mission
- 9 Quality
- 11 Company History
- 13 Vario Lumen, Vario Kelvin
- 17 Suspension
- 79 Wall
- 149 Pedestal
- 171 Recessed
- 189 Table Lamp
- 207 Track lights

## PRODUCT INDEX

SUSPENSION	WALL	PEDESTAL	RECESSED	TABLE LAMP	TRACK LIGHTS
17 Aquadro	79 Stargate	149 Amadeus	173 Tondo Led	189 Lina	209 Beba
21 Eliot	83 Alba	153 Silence	173 Orient Led	193 Squadra	211 Lerica
25 Nori	87 Tink	157 Utile	174 Demi Led	197 Sphere	
29 Squak	91 Faces	161 Zero	174 Orient Q Led	201 Stilo	
33 Loft	95 Calea	165 Birba	177 Sei		
37 Maciste	99 Zoe		179 Uno		
41 Round	103 Talè		181 Rio		
45 Round IP55	107 Ester		183 Remisi Colour		
49 Arrondo	111 Dudu		185 Hollow		
53 Ufo	115 Dosi				
57 Tubi	119 Gina				
62 Adalpina	123 Mali				
65 Circo	127 Leila				
69 Olimpia	131 Norton				
73 Libra	135 Pia				
	139 Trem				
	143 Bombei				



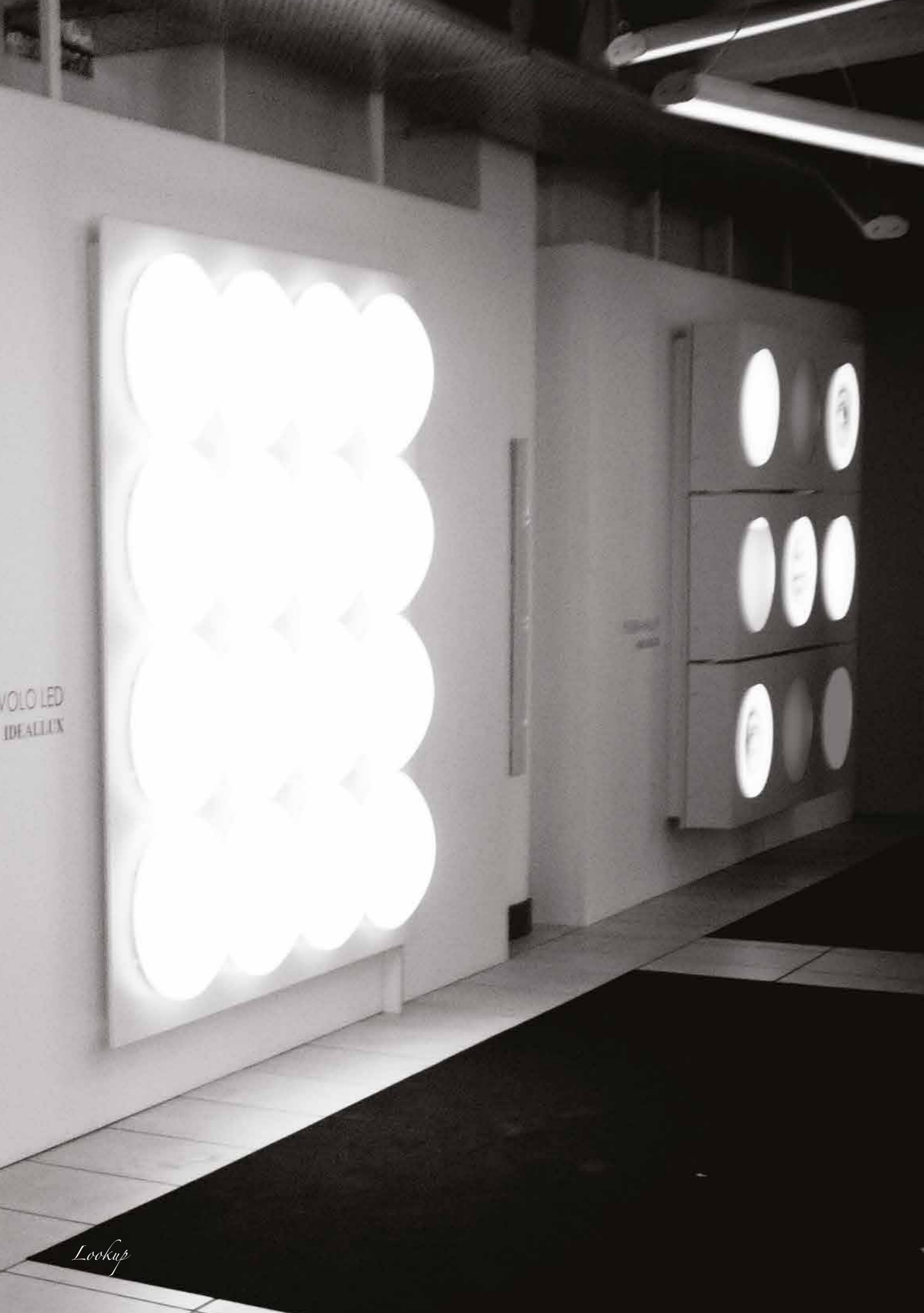

VOLO LED  
IDEALLUX

Lookup

# INDEX

## ILLUSTRATED INDEX

### SUSPENSION



Aquadro  
p. 17



Eliot  
p. 21



Nori  
p. 25



Squak  
p. 29



Loft  
p. 33



Maciste  
p. 37



Round  
p. 41



Round IP55  
p. 45



Arrondo  
p. 49



Ufo  
p. 53



Tubi  
p. 57



Adalpina  
p. 62



Circo  
p. 65



Olimpia  
p. 69



Libra  
p. 73

### WALL



Stargate  
p. 79



Alba  
p. 83



Tink  
p. 87



Faces  
p. 91



Calea  
p. 95



Zoe  
p. 99



Talè  
p. 103



Ester  
p. 107



Dudu  
p. 111



Dosi  
p. 115



Gina  
p. 119



Mali  
p. 123



Leila  
p. 127



Norton  
p. 131



Pia  
p. 135



Trem  
p. 139



Bombei  
p. 143





# INDEX

## ILLUSTRATED INDEX

### PEDESTAL



Amadeus  
p. 149



Silence  
p. 153



Utile  
p. 157



Zero  
p. 161

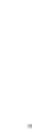

Birba  
p. 165

### RECESSED



Tondo Led  
p. 173



Orient Led  
p. 173



Demi Led  
p. 174



Orient Q Led  
p. 174



Sei  
p. 177



Uno  
p. 179



Rio  
p. 181



Remisi Color  
p. 183



Hallow  
p. 185

### TABLE LAMP



Lina  
p. 189



Squadra  
p. 193

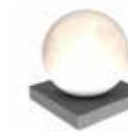

Sphere  
p. 197



Stilo  
p. 201

### TRACK LIGHTS



Beba V  
p. 209



Lerica V  
p. 211



## CHI SIAMO

Il **GRUPPO RAINA** è il brand che raggruppa sotto lo stesso nome i marchi:

**IDEALLUX** produzione storica specializzata nella realizzazione e vendita di apparecchi destinati ai settori dell'industria e del terziario.

**COLOMBO** marchio specifico per gli apparecchi stradali, arredo urbano e da esterno.

**LOOKUP** con la sua nuova e ampia gamma di apparecchi decorativi e architettonici.



**IDEALLUX®** **COLOMBO** *Lookup*

## MISSION

Il gruppo ha come mission la progettazione e la produzione di sistemi di illuminazione, caratterizzati da un'elevata tecnologia e da un ottimo rendimento, totalmente realizzati nello stabilimento di Cilavegna, in Provincia di Pavia e certificati 100% Made in Italy. Gruppo Raina vanta tra le certificazioni ottenute la certificazione ISO 9001:2008 e la certificazione 100% Made in Italy rilasciata dall'Istituto Per la Tutela dei Produttori Italiani. I numeri del gruppo riassumono le capacità dello stesso, con i suoi 12.000 mq di stabilimento produttivo, 7.000 mq di magazzino, 100 risorse impiegate e oltre 3.800 clienti attivi.



## QUALITÀ

Nell'ottica della soddisfazione del cliente e dell'ottimizzazione del servizio, Ideallux ha messo in atto processi di controllo qualità con l'obiettivo di limitare la difettosità, che si è attestata ad una percentuale inferiore all'1% (dato statistico ISO degli ultimi tre anni).

## LA STORIA

1987

**Ideallux viene fondata nel 1987 per volontà di Claudio Raina.**

Nasce come azienda artigiana di produzione di apparecchi di illuminazione, per divenire in pochi anni un'importante realtà industriale del settore di illuminazione.

2011

**Nel 2011 avviene il passaggio dalle fonti tradizionali alle nuove tecnologie LED.**

Ideallux lancia un catalogo dedicato esclusivamente ad apparecchi di illuminazione LED, affiancandolo all'ormai consolidato catalogo di prodotti fluorescenza.

2017

**Il 2017 ha segnato il traguardo dei 30 ANNI di attività.**

Il Fuorisalone 2017 – Via Tortona – Milano è stata la location perfetta per festeggiare questa importantissima tappa, presentando i prodotti Ideallux con una nuova veste.

2018

**Nel 2018, in occasione di Light+Building, la più prestigiosa fiera dell'illuminazione nel panorama internazionale, Ideallux presenta al mondo del lighting il nuovo Gruppo Raina.**

Gruppo Raina è il brand che raggruppa sotto lo stesso nome i marchi Ideallux, Lookup e Colombo

2018

**Il 01.10 segna un'altra nuova importante tappa della storia del gruppo.**

Viene presentata e lanciata sul mercato l'ampia gamma del brand Look up, caratterizzata da apparecchi decorativi dal design moderno alcuni dei quali dotati della nuova tecnologia dei marchi depositati.

Vario Lumen e Vario Kelvin.







## VARIO LUMEN E VARIO KELVIN

Vario Lumen™ e Vario Kelvin™, due sistemi di controllo che rendono l'illuminazione facile, confortevole e conveniente.

Facile perché con i sistemi **Vario Lumen™** e **Vario Kelvin™** è possibile regolare l'intensità luminosa ed il colore della luce emessa, semplicemente agendo sul corpo illuminante senza interfacce software, app e/o altri dispositivi. Confortevole perché sarà il cliente a decidere la quantità di luce e la temperatura di colore adattandola all'ambiente da illuminare o al proprio gusto personale.

**CONVENIENTE PERCHÉ UN SOLO APPARECCHIO PERMETTE DI SODDISFARE DIFFERENTI ESIGENZE ILLUMINOTECNICHE.**



L'innovativo sistema **Vario Kelvin™** del **Gruppo Raina** permette di variare la temperatura di colore degli apparecchi di illuminazione, mediante un selettore opportunamente integrato nel prodotto. La semplicità della tecnologia **Vario Kelvin™** rende la soluzione accessibile in modo economico a tutta la filiera, contrariamente ad altre tecnologie più costose e complesse. **Vario Kelvin™** del **Gruppo Raina** permette con un unico codice prodotto la scelta tra tre diverse temperature di colore: per le applicazioni tecniche residenziali o del retail 2700K, 3350K, 4000K; per gli impianti industriali 3000K, 4000K, 6000K.



4000 K



3350 K



2700 K



Il sistema **Vario Lumen™** adotta una tecnologia che permette di variare la potenza e quindi la quantità di lumen emessi dagli apparecchi di illuminazione del **Gruppo Raina**. Questo innovativo sistema, permette di ottimizzare i magazzini dei distributori di materiale elettrico e risolvere problematiche di impianto durante la fase di installazione ai clienti impiantisti. Con un unico codice prodotto, si possono raggiungere fino ad un massimo di cinque livelli di regolazione di flusso luminoso.

Con la tecnologia **Vario Lumen™**, scegliere la luce che occorre è economico e facile.



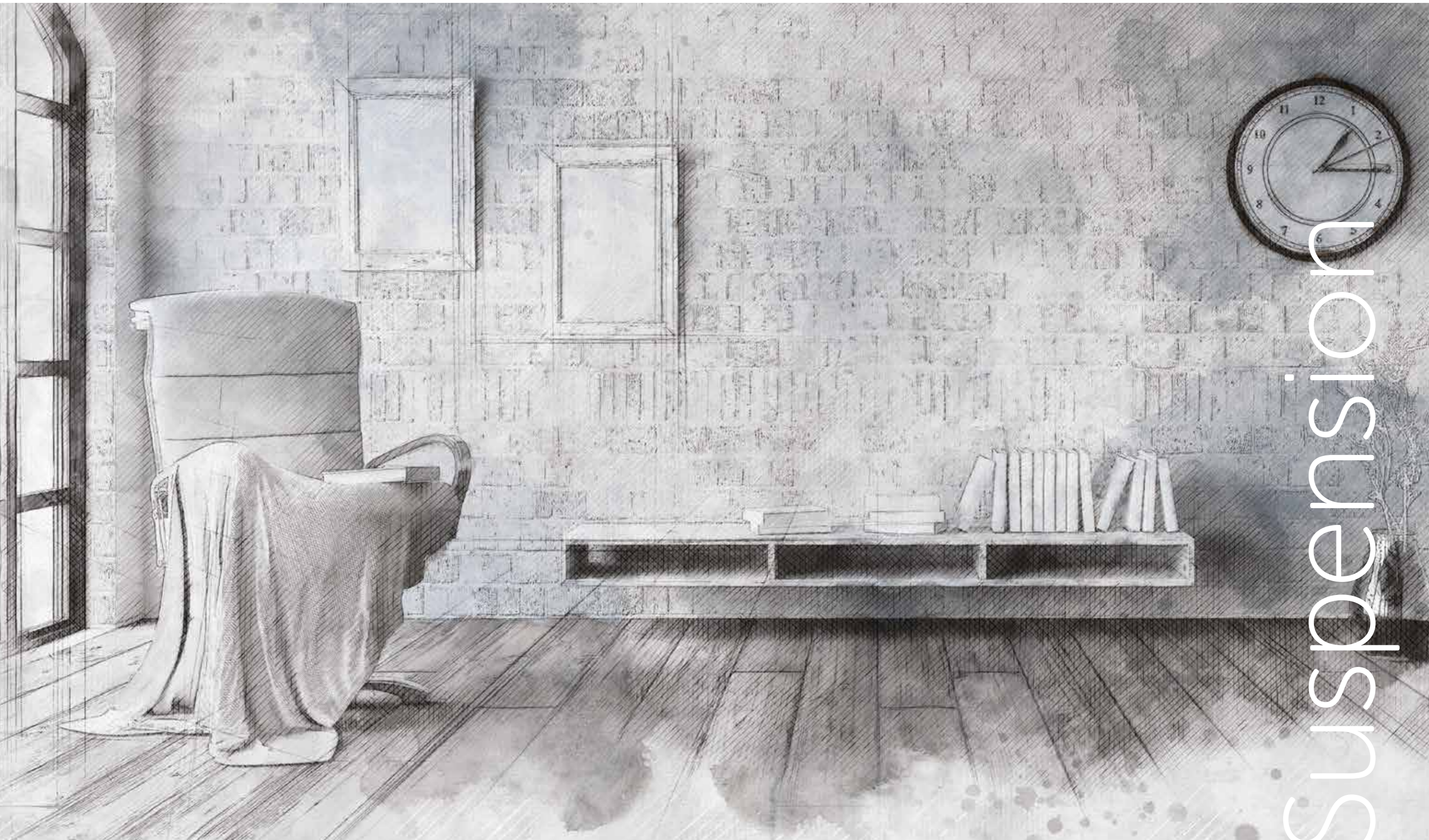

# Suspension







# Aquadro

## AQUADRO

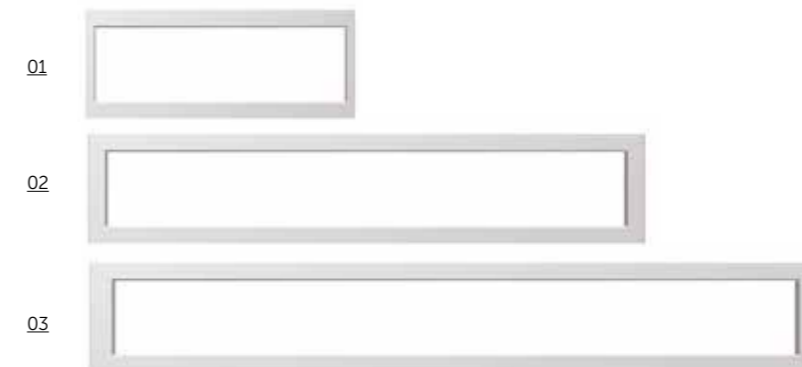

### Suspension



| On request - p.XXX |

### IT

Apparecchio decorativo per installazione a sospensione. Corpo in acciaio al carbonio pressopiegato. Sorgente luminosa LED multichip. Verniciatura con polveri epossidiche antigraffio. Schermo di chiusura in policarbonato opale.

### ES

Luminaria decorativa de suspensión. Cuerpo de acero al carbono plegado. Fuente de iluminación LED multichip. Recubierta con polvo epoxi anti-rayado. Difusor de policarbonato opal.

### GB

Decorative suspension lighting fitting. Bent carbon steel body. Multichip LED lighting source. Anti-scratch epoxy powder paint finish. Opal polycarbonate closing reflector.

### DE

Dekoratives Hängebeleuchtungsgerät. Körper aus pressgeformtem Kohlenstoffstahl. Multichip LED-Leuchtmittel. Lackierung mit kratzfesten Epoxypulvern. Abdeckschirm aus opalem Polycarbonat.

### FR

Appareils décoratif en suspension. Corps en acier au carbone courbé. Source de lumière en LED multichip. Finition de peinture en poudre époxy anti-rayures. Écran de fermeture en polycarbonate opale.

### RU

Декоративный подвесной светильник. Корпус из прессованной углеродистой стали. Источник света мульткристальный СИД. Покрытие устойчивым к царапинам оксидным порошком. Закрывающий экран выполнен из матового поликарбоната.

### AQUADRO

Code	Size	Lumen	Watt	K	Beam angle	Driver Type	Driver Nr.	Colour
YAQ06W	01	2800	28	W	D	ON/OFF	1	○
YAQ12W	02	5600	56	W	D	ON/OFF	1	○
YAQ15W	03	7000	70	W	D	ON/OFF	1	○

### ○ AQUADRO COLOUR SELECTION

- SB | Silver Bombalai
- BL | Bronze Lario
- RR | Rust Rame
- BF | Beige Futuna
- WI | White Irazu
- GK | Gold Karkar
- BT | Blue Telica
- BLL | Black Lava
- CO | Corten
- PC | Primer Coating

### AQUADRO BEAM ANGLE | DIMENSIONS

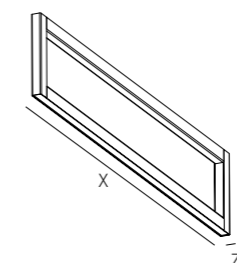

Size	X (mm)	Y (mm)	Z (mm)	Kg
01	630	220	30	
02	1130	220	30	
03	1530	220	30	



Eliot

# Eliot

ELIOT



## Suspension



| On request - p.XXX |

### IT

Apparecchio decorativo per installazione a sospensione. Corpo in acciaio al carbonio pressopiegato. Sorgente luminosa LED multichip. Verniciatura con polveri epossidiche antigraffio. Schermo di chiusura in policarbonato opale.

### ES

Luminaria decorativa de suspensión. Cuerpo de acero al carbono plegado. Fuente de iluminación LED multichip. Recubierta con polvo epoxi anti-rayado. Difusor de policarbonato opal.

### GB

Decorative suspension lighting fitting. Bent carbon steel body. Multichip LED lighting source. Anti-scratch epoxy powder paint finish. Opal polycarbonate closing reflector.

### DE

Dekoratives Hängebeleuchtungsgerät. Körper aus pressgeformtem Kohlenstoffstahl. Multichip LED-Leuchtmittel. Lackierung mit kratzfesten Epoxypulvern. Abdeckschirm aus opalem Polycarbonat.

### FR

Appareils décoratif en suspension. Corps en acier au carbone courbé. Source de lumière en LED multichip. Finition de peinture en poudre époxy anti-rayures. Écran de fermeture en polycarbonate opale.

### RU

Декоративный подвесной светильник. Корпус из прессованной углеродистой стали. Источник света мульткристальный СИД. Покрытие устойчивым к царапинам эпоксидным порошком. Закрывающий экран выполнен из матового поликарбоната.

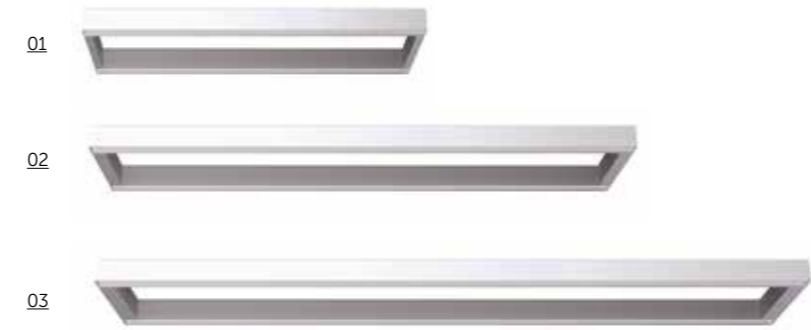

## ELIOT

Code	Size	Lumen	Watt	K	Beam angle	Driver Type	Driver Nr.	Colour
YEL06W	01	2800	28	W	D	ON/OFF	1	○
YEL12W	02	5600	56	W	D	ON/OFF	1	○
YEL15W	03	7000	70	W	D	ON/OFF	1	○

## ELIOT COLOUR SELECTION

- **SB** | Silver Bombalai
- **BL** | Bronze Lario
- **RR** | Rust Rame
- **BF** | Beige Futuna
- **WI** | White Irazu
- **GK** | Gold Karkar
- **BT** | Blue Telica
- **BLL** | Black Lava
- **CO** | Corten
- **PC** | Primer Coating

## ELIOT BEAM ANGLE | DIMENSIONS

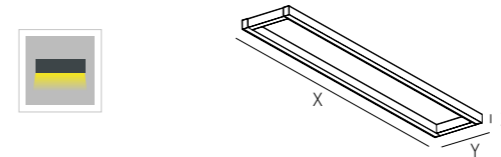

Size	X [mm]	Y [mm]	Z [mm]	Kg
01	630	205	30	
02	1130	205	30	
03	1530	205	30	





# Nori

NORI



Suspension



| On request - p.XXX |

**IT**

Apparecchio decorativo per installazione a sospensione. Corpo in alluminio estruso. Sorgente luminosa LED multichip. Verniciatura con polveri epossidiche antigraffio. Schermo di chiusura in policarbonato opale.

**ES**

Luminaria decorativa de suspensión. Cuerpo en aluminio extruido. Fuente de iluminación LED multichip. Recubierta con polvo epoxi anti-rayado. Difusor de policarbonato opal.

**GB**

Decorative suspension lighting fitting. Extruded aluminium body. Multichip LED lighting source. Anti-scratch epoxy powder paint finish. Opal polycarbonate closing reflector.

**DE**

Dekoratives Hängebeleuchtungsgerät. Körper aus extrudiertem Aluminium Multichip LED-Leuchtmittel. Lackierung mit kratzfesten Epoxypulvern. Abdeckschirm aus opalem Polycarbonat.

**FR**

Appareils décoratif en suspension. Corps en aluminium extrudé. Source de lumière en LED multichip. Finition de peinture en poudre époxy anti-rayures. Écran de fermeture en polycarbonate opale.

**RU**

Xxxxx xxxx

**NORI**

Code	Size	Lumen	Watt	K	Beam angle	Driver Type	Driver Nr.	Colour
YNR6W	01	1400	14	W	D	ON/OFF	1	○
YNR12W	02	2800	28	W	D	ON/OFF	1	○
YNR15W	03	3500	35	W	D	ON/OFF	1	○

○ **NORI** COLOUR SELECTION

- **SB** | Silver Bombalai
- **BL** | Bronze Lario
- **RR** | Rust Rame
- **BF** | Beige Futuna
- **WI** | White Irazu
- **GK** | Gold Karkar
- **BT** | Blue Telica
- **BLL** | Black Lava
- **CO** | Corten
- ▨ **PC** | Primer Coating

**NORI** BEAM ANGLE | DIMENSIONS

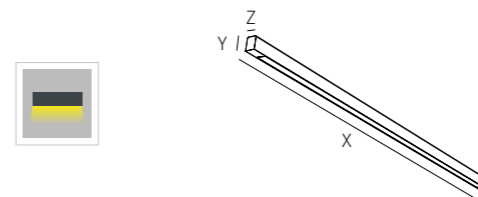

Size	X [mm]	Y [mm]	Z [mm]	Kg
<b>01</b>	35	26	680	
<b>02</b>	35	26	1180	
<b>03</b>	35	26	1580	







# Squak

# SQUAK

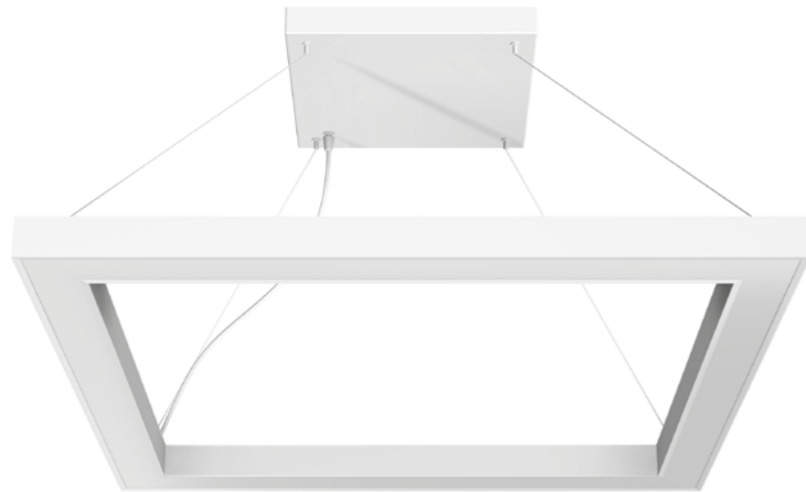

01



02

## Suspension



| On request - p.XXX |

### IT

Apparecchio decorativo per installazione a sospensione. Corpo in alluminio estruso. Sorgente luminosa LED multichip. Verniciatura con polveri epossidiche antigraffio. Schermo di chiusura in policarbonato opale.

### ES

Luminaria decorativa de suspensión. Cuerpo en aluminio extruido. Fuente de iluminación LED multichip. Recubierta con polvo epoxi anti-rayado. Difusor de policarbonato opal.

### GB

Decorative suspension lighting fitting. Extruded aluminium body. Multichip LED lighting source. Anti-scratch epoxy powder paint finish. Opal polycarbonate closing reflector.

### DE

Dekoratives Hängebeleuchtungsgerät. Körper aus extrudiertem Aluminium. Multichip LED-Leuchtmittel. Lackierung mit kratzfesten Epoxypulvern. Abdeckschirm aus opalem Polycarbonat.

### FR

Appareils décoratif en suspension. Corps en aluminium extrudé. Source de lumière en LED multichip. Finition de peinture en poudre époxy anti-rayures. Écran de fermeture en polycarbonate opale.

### RU

Xxxxx xxxx

## SQUAK

Code	Size	Lumen	Watt	K	Beam angle	Driver Type	Driver Nr.	Colour
YSQ60W	01	8450	57	W	D	ON/OFF	1	○
YSQ80W	02	10600	72	W	D	ON/OFF	1	○

## ○ SQUAK COLOUR SELECTION

- **SB** | Silver Bombalai
- **BL** | Bronze Lario
- **RR** | Rust Rame
- **BF** | Beige Futuna
- **WI** | White Irazu
- **GK** | Gold Karkar
- **BT** | Blue Telica
- **BLL** | Black Lava
- **CO** | Corten
- **PC** | Primer Coating

## SQUAK BEAM ANGLE | DIMENSIONS

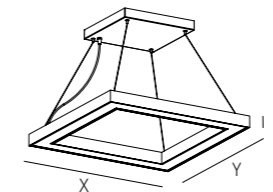

Size	X [mm]	Y [mm]	Z [mm]	Kg
<b>01</b>	600	600	45	
<b>02</b>	800	800	45	



Loft



LOFT



Suspension



| On request - p.XXX |

IT

Apparecchio decorativo per installazione a sospensione. Corpo in alluminio tornito. Sorgente luminosa LED multichip. Verniciatura con polveri epossidiche antigraffio. Schermo di chiusura in policarbonato opale.

GB

Decorative suspension lighting fitting. Turned aluminium body. Multichip LED lighting source. Anti-scratch epoxy powder paint finish. Opal polycarbonate closing reflector.

FR

Appareils décoratif en suspension. Corps en aluminium tourné. Source de lumière en LED multichip. Finition de peinture en poudre époxy anti-rayures. Écran de fermeture en polycarbonate opale.

ES

Luminaria decorativa de suspensión. Cuerpo en aluminio torneado. Fuente de iluminación LED multichip. Recubierta con polvo epoxi anti-rayado. Difusor de policarbonato opal.

DE

Dekoratives Hängebeleuchtungsgerät. Körper aus gedrehtem Aluminium. Multichip LED-Leuchtmittel. Lackierung mit kratzfesten Epoxypulvern. Abdeckschirm aus opalem Polycarbonat.

RU

Xxxxx xxxx

LOFT VARIO LUMEN | VARIO KELVIN

Code	Size	Vario Lumen	Watt	K	Beam angle	Driver Type	Driver Nr.	Colour
YLO11VKLW	01	960   1440   1920	7   10,5   14	Vario	D	ON/OFF	1	○
YLO27VKLW	01	1920   2880   3840	14   21   27	Vario	D	ON/OFF	1	○

LOFT

Code	Size	Lumen	Watt	K	Beam angle	Driver Type	Driver Nr.	Colour
YLO22W	01	3220	22	W	D	ON/OFF	1	○
YLO27W	01	3840	27	W	D	ON/OFF	1	○
YLO41W	01	5590	41	W	D	ON/OFF	1	○
YLO47W	01	6350	47	W	D	ON/OFF	1	○

LOFT COLOUR SELECTION

- SB | Silver Bombalai
- BL | Bronze Lario
- RR | Rust Rame
- BF | Beige Futuna
- WI | White Irazu
- GK | Gold Karkar
- BT | Blue Telica
- BLL | Black Lava
- CO | Corten
- PC | Primer Coating

LOFT BEAM ANGLE | DIMENSIONS

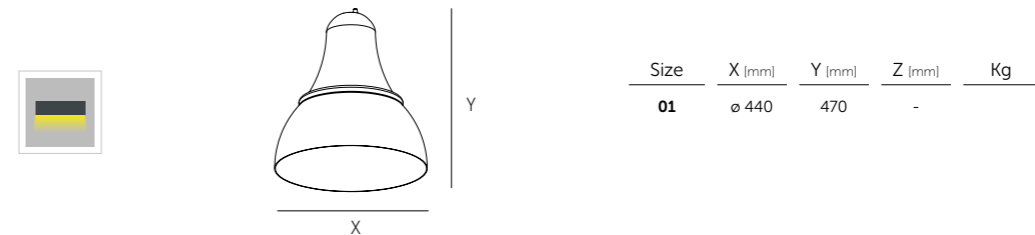





# Maciste

## MACISTE



Suspension



| On request - p.XXX |

### IT

Apparecchio decorativo per installazione a sospensione. Corpo in alluminio estruso. Sorgente luminosa LED multichip. Verniciatura con polveri epossidiche antigraffio. Realizzato con tre ottiche orientabili indipendenti.

### ES

Luminaria decorativa de suspensión. Cuerpo en aluminio extruido. Fuente de iluminación LED multichip. Recubierta con polvo epoxi anti-rayado. Realizado con tres ópticas orientables independientes.

### GB

Decorative suspension lighting fitting. Extruded aluminium body. Multichip LED lighting source. Anti-scratch epoxy powder paint finish. Equipped with three independent adjustable optics.

### DE

Dekoratives Hängebeleuchtungsgerät. Körper aus extrudiertem Aluminium. Multichip LED-Leuchtmittel. Lackierung mit kratzfesten Epoxypulvern. Produziert mit drei unabhängigen einstellbaren Optiken.

### FR

Appareils décoratif en suspension. Corps en aluminium extrudé. Source de lumière en LED multichip. Finition de peinture en poudre époxy anti-rayures. Fabriqué avec trois optiques réglables indépendantes.

### RU

Xxxxx xxxx

### MACISTE

Code	Size	Lumen	Watt	K	Beam angle	Driver Type	Driver Nr.	Colour
YMA320W	01	9900	3x20	W	C   D	ON/OFF	1	○
YMA324W	01	11400	3x24	W	C   D	ON/OFF	1	○
YMA327W	01	12300	3x27	W	C   D	ON/OFF	1	○
YMA333W	01	14140	3x33	W	C   D	ON/OFF	1	○
YMA339W	01	18600	3x39	W	C   D	ON/OFF	1	○

### MACISTE COLOUR SELECTION

- **SB** | Silver Bombalai
- **BL** | Bronze Lario
- **RR** | Rust Rame
- **BF** | Beige Futuna
- **WI** | White Irazu
- **GK** | Gold Karkar
- **BT** | Blue Telica
- **BLL** | Black Lava
- **CO** | Corten
- ▨ **PC** | Primer Coating

### MACISTE BEAM ANGLE | DIMENSIONS

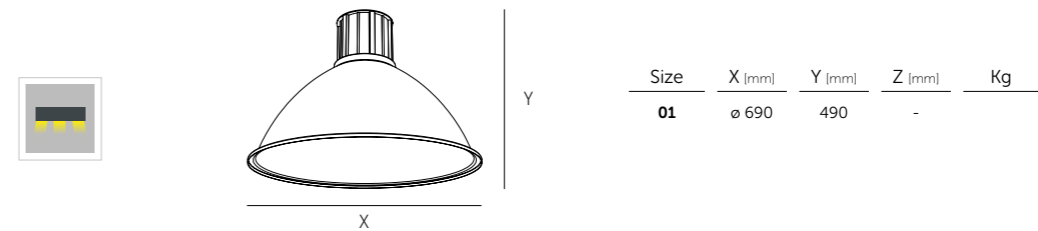





# Round



## ROUND

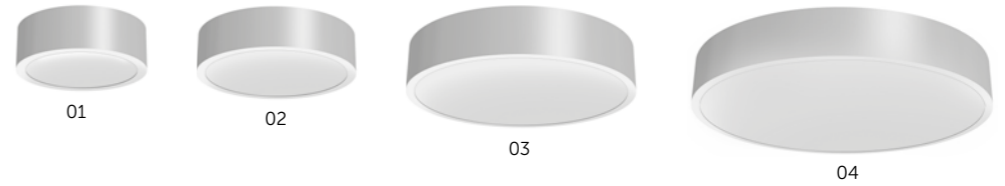

Suspension  
Ceiling mounted



| On request - p.XXX | Code: YKT35 (size 01-02) | Code: YKT45 (size 03-04) |

### IT

Apparecchio decorativo per installazione a sospensione o plafone. Corpo in alluminio tornito. Sorgente luminosa LED multichip. Verniciatura con polveri epossidiche antigraffio. Schermo di chiusura in policarbonato opale

### ES

Luminaria decorativa de suspensión o techo. Cuerpo en aluminio torneado. Fuente de iluminación LED multichip. Recubierta con polvo epoxi anti-rayado. Difusor de policarbonato opal.

### GB

Decorative suspension lighting fitting or ceiling mounted. Turned aluminium body. Multichip LED lighting source. Anti-scratch epoxy powder paint finish. Opal polycarbonate closing reflector.

### DE

Dekoratives Hänge- und Deckenbeleuchtungsgerät. Körper aus gedrehtem Aluminium. Multichip LED-Leuchtmittel. Lackierung mit kratzfesten Epoxypulvern. Abdeckschirm aus opalem Polycarbonat.

### FR

Appareils décoratif en suspension ou plafond. Corps en aluminium tourné. Source de lumière en LED multichip. Finition de peinture en poudre époxy anti-rayures. Écran de fermeture en polycarbonate opale.

### RU

Xxxxx xxxx

### ROUND VARIO LUMEN | VARIO KELVIN

Code	Size	Vario Lumen	Watt	K	Beam angle	Driver Type	Driver Nr.	Colour
YRO55VKLW	X	4850   7270   9700	33   49   65	Vario	D	ON/OFF	1	○
YRO75VKLW	X	8750   13125   17500	60   90   120	Vario	D	ON/OFF	1	○

### ROUND

Code	Size	Lumen	Watt	K	Beam angle	Driver Type	Driver Nr.	Colour
YRO27W	01	2500	21	W	D	ON/OFF	1	○
YRO36W	02	4000	25	W	D	ON/OFF	1	○
YRO55W	03	9700	65	W	D	ON/OFF	1	○
YRO75W	04	17500	120	W	D	ON/OFF	1	○

### ○ ROUND COLOUR SELECTION

- SB | Silver Bombalai
- BL | Bronze Lario
- RR | Rust Rame
- BF | Beige Futuna
- WI | White Irazu
- GK | Gold Karkar
- BT | Blue Telica
- BLL | Black Lava
- CO | Corten
- PC | Primer Coating

### ROUND BEAM ANGLE | DIMENSIONS

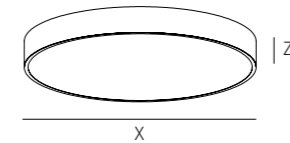

Size	X [mm]	Y [mm]	Z [mm]	Kg
01	ø 270	-	90	
02	ø 360	-	90	
03	ø 550	-	110	
04	ø 750	-	110	





# Round IP55



## ROUND IP55



Suspension  
Ceiling mounted



| On request - p.XXX | | Code: YKT45 |

### IT

Apparecchio decorativo per installazione a sospensione o plafone. Corpo in alluminio tornito. Sorgente luminosa LED multichip. Verniciatura con polveri epossidiche antigraffio. Schermo di chiusura in policarbonato opale.

### ES

Luminaria decorativa de suspensión o techo. Cuerpo en aluminio torneado. Fuente de iluminación LED multichip. Recubierta con polvo epoxi anti-rayado. Difusor de policarbonato opal.

### GB

Decorative suspension lighting fitting or ceiling mounted. Turned aluminium body. Multichip LED lighting source. Anti-scratch epoxy powder paint finish. Opal polycarbonate closing reflector.

### DE

Dekoratives Hänge- und Deckenbeleuchtungsgerät. Körper aus gedrehtem Aluminium. Multichip LED-Leuchtmittel. Lackierung mit kratzfesten Epoxypulvern. Abdeckschirm aus opalem Polycarbonat.

### FR

Appareils décoratif en suspension ou plafond. Corps en aluminium tourné. Source de lumière en LED multichip. Finition de peinture en poudre époxy anti-rayures. Écran de fermeture en polycarbonate opale.

### RU

Xxxxx xxxx

### ROUND IP55 VARIO LUMEN | VARIO KELVIN

Code	Size	Vario Lumen	Watt	K	Beam angle	Driver Type	Driver Nr.	Colour
YR060VKLW	01	4850   7270   9700	33   49   65	Vario	D	ON/OFF	1	○
YR090VKLW	02	8750   13125   17500	60   90   120	Vario	D	ON/OFF	1	○
YR120VKLW	03	13000   19500   26000	88   132   170	Vario	D	ON/OFF	1	○

### ROUND IP55

Code	Size	Lumen	Watt	K	Beam angle	Driver Type	Driver Nr.	Colour
YR060W	01	9700	65	W	D	ON/OFF	1	○
YR090W	02	17300	120	W	D	ON/OFF	1	○
YR120W	03	26000	175	W	D	ON/OFF	1	○

### ○ ROUND IP55 COLOUR SELECTION

- SB | Silver Bombalai
- BL | Bronze Lario
- RR | Rust Rame
- BF | Beige Futuna
- WI | White Irazu
- GK | Gold Karkar
- BT | Blue Telica
- BLL | Black Lava
- CO | Corten
- PC | Primer Coating

### ROUND IP55 BEAM ANGLE | DIMENSIONS

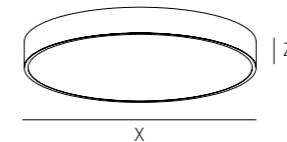

Size	X [mm]	Y [mm]	Z [mm]	Kg
01	∅ 600	-	150	
02	∅ 900	-	150	
03	∅ 1200	-	150	



# ARRONDO

## ARRONDO

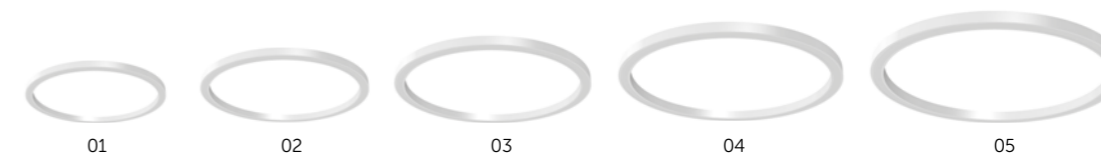

### Suspension



| On request - p.XXX |

#### IT

Apparecchio decorativo per installazione a sospensione. Corpo in acciaio al carbonio calandrato e pressopiegato. Sorgente luminosa LED multichip. Verniciatura con polveri epossidiche antigraffio. Schermo di chiusura in policarbonato opalino.

#### GB

Decorative suspension lighting fitting. Bent and calandered carbon steel body. Multichip LED lighting source. Anti-scratch epoxy powder paint finish. Opal polycarbonate closing reflector.

#### FR

Appareils décoratif en suspension. Corps en acier au carbone courbé et calandré. Source de lumière en LED multichip. Finition de peinture en poudre époxy anti-rayures. Écran de fermeture en polycarbonate opale.

#### ES

Luminaria decorativa de suspensión. Cuerpo de acero al carbono plegado y calandrado. Fuente de iluminación LED multichip. Recubierta con polvo epoxi anti-rayado. Difusor de policarbonato opal.

#### DE

Dekoratives Hängebeleuchtungsgerät. Körper aus kalandriertem und pressgeformtem Kohlenstoffstahl Multichip LED-Leuchtmittel. Lackierung mit kratzfesten Epoxypulvern. Abdeckschirm aus opalem Polycarbonat.

#### RU

Xxxxx xxxx

### ARRONDO

Code	Size	Lumen	Watt	K	Beam angle	Driver Type	Driver Nr.	Colour
YAR10W	01	11300	76	W	D	ON/OFF	1	○
YAR12W	02	14040	94	W	D	ON/OFF	1	○
YAR15W	03	16200	108	W	D	ON/OFF	1	○
YAR20W	04	27680	152	W	D	ON/OFF	1	○
YAR30W	05	35640	216	W	D	ON/OFF	1	○

### ARRONDO COLOUR SELECTION

- **SB** | Silver Bombalai
- **BL** | Bronze Lario
- **RR** | Rust Rame
- **BF** | Beige Futuna
- **WI** | White Irazu
- **GK** | Gold Karkar
- **BT** | Blue Telica
- **BLL** | Black Lava
- **CO** | Corten
- **PC** | Primer Coating

### ARRONDO BEAM ANGLE | DIMENSIONS

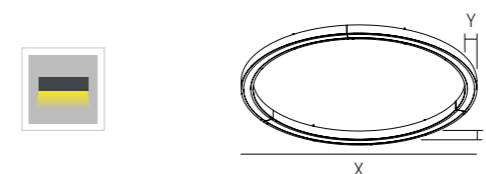

Size	X [mm]	Y [mm]	Z [mm]	Kg
<b>01</b>	∅ 1000	100	80	
<b>02</b>	∅ 1200	100	80	
<b>03</b>	∅ 1500	100	80	
<b>04</b>	∅ 2000	100	80	
<b>05</b>	∅ 3000	100	100	



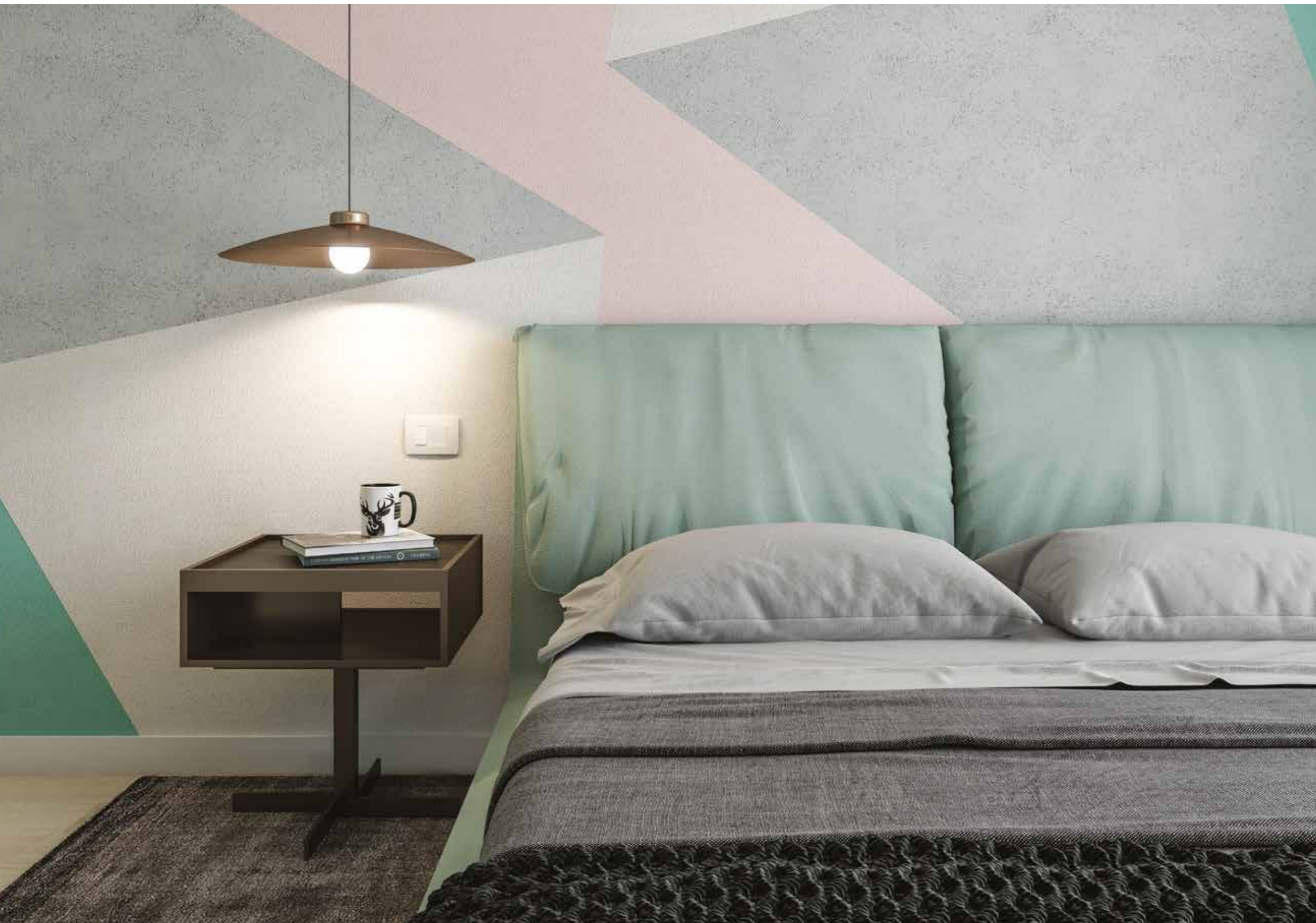

Ufo

UFO

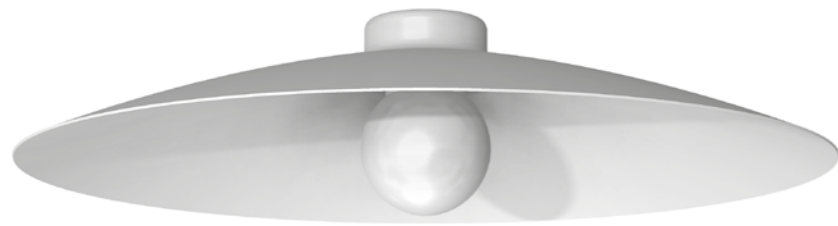

Suspension



| On request - p.XXX |

IT

Apparecchio decorativo per installazione a sospensione. Corpo in alluminio tornito. Sorgente luminosa con lampada LED sostituibile E27 (non inclusa). Verniciatura con polveri epossidiche antigraffio.

GB

Decorative suspension lighting fitting. Turned aluminium body. Light source with replaceable E27 LED lamp (not included) Anti-scratch epoxy powder paint finish.

FR

Appareils décoratif en suspension. Corps en aluminium tourné. Source lumineuse avec lampe à LED E27 remplaçable (non fournie). Finition de peinture en poudre époxy anti-rayures.

ES

Luminaria decorativa de suspensión. Cuerpo en aluminio torneado. Fuente de iluminación con lámpara LED sustituible E27 (no incluida). Recubierta con polvo epoxi anti-rayado.

DE

Dekoratives Hängebeleuchtungsgerät. Körper aus gedrehtem Aluminium. Leuchtmittel mit austauschbarer LED Lampe E27 (nicht enthalten). Lackierung mit kratzfesten Epoxypulvern.

RU

Xxxxx xxxx

UFO

Code	Size	Lamp Type	Watt	K	Beam angle	Driver Type	Driver Nr.	Colour
YUF01W	01	E27	Max 21 W	W	D	ON/OFF	1	○

○ UFO COLOUR SELECTION

- **SB** | Silver Bombalai
- **BL** | Bronze Lario
- **RR** | Rust Rame
- **BF** | Beige Futuna
- **WI** | White Irazu
- **GK** | Gold Karkar
- **BT** | Blue Telica
- **BLL** | Black Lava
- **CO** | Corten
- ▨ **PC** | Primer Coating

UFO BEAM ANGLE | DIMENSIONS

Size	X [mm]	Y [mm]	Z [mm]	Kg
01	Ø 500	-	95	



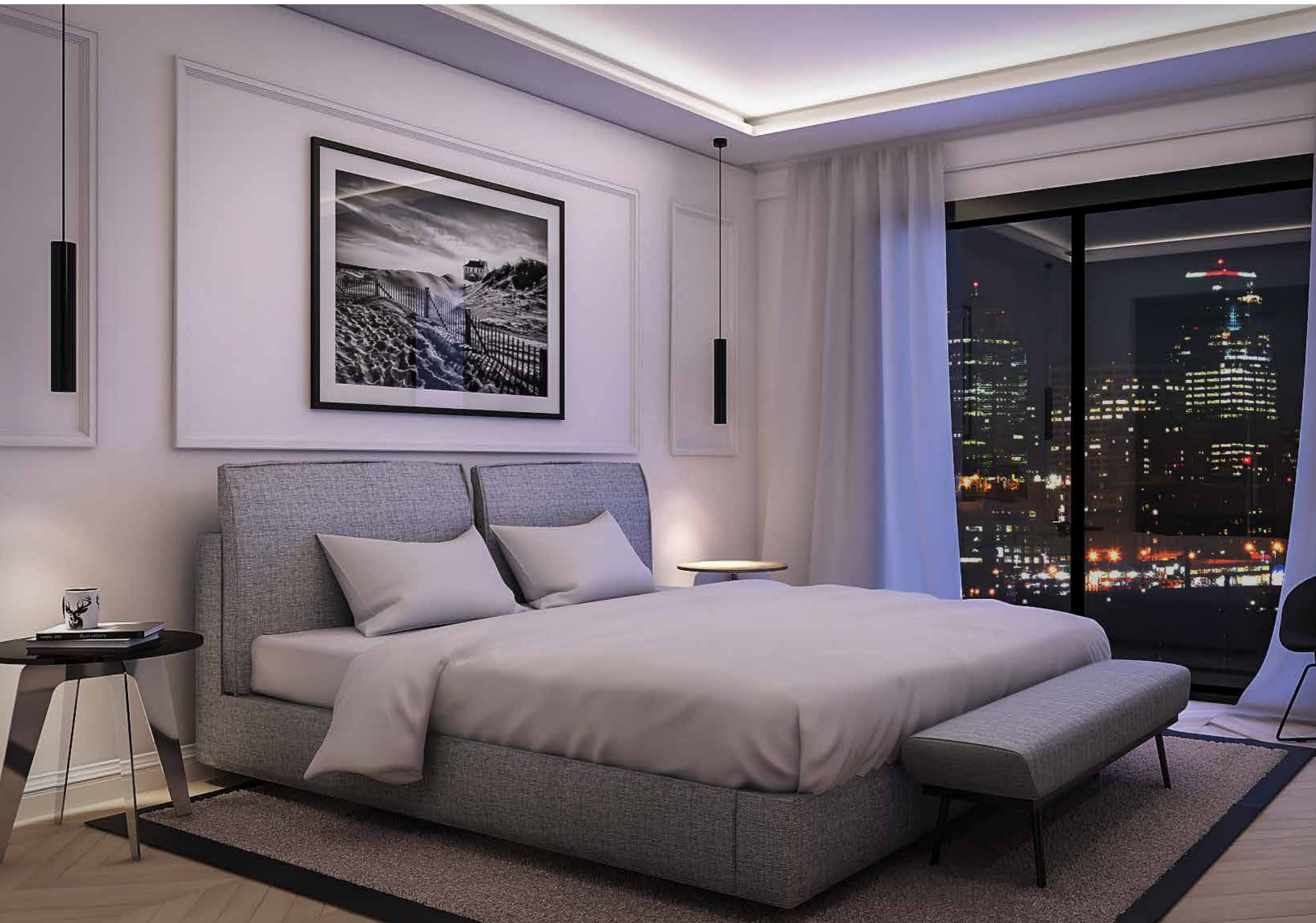

Tubi



# Tubi

# TUBÌ



01



02



03

Suspension  
Ceiling mounted



| On request - p.XXX |

## IT

Apparecchio decorativo per installazione a sospensione. Corpo in alluminio estruso. Sorgente luminosa con lampada LED sostituibile GU10 (non inclusa). Verniciatura con polveri epossidiche antigraffio.

## GB

Decorative suspension lighting fitting. Extruded aluminium body. Light source with replaceable GU10 LED lamp (not included). Anti-scratch epoxy powder paint finish.

## FR

Appareils décoratif en suspension. Corps en aluminium extrudé. Source lumineuse avec lampe à LED GU10 remplaçable (non fournie). Finition de peinture en poudre époxy anti-rayures.

## ES

Luminaria decorativa de suspensión. Cuerpo en aluminio extruido. Fuente de iluminación con lámpara LED sustituible GU10 (no incluida). Recubierta con polvo epoxi anti-rayado.

## DE

Dekoratives Hängebeleuchtungsgerät. Körper aus extrudiertem Aluminium. Leuchtmittel mit austauschbarer LED Lampe GU10 (nicht enthalten). Lackierung mit kratzfesten Epoxypulvern.

## RU

Xxxxx xxxx

## TUBÌ S

Code	Size	Lamp Type	Watt	K	Beam angle	Driver Type	Driver Nr.	Colour
YTUS14W	01	GU 10	Max 10 W	W	D	ON/OFF	1	○
YTUS40W	02	GU 10	Max 10 W	W	D	ON/OFF	1	○
YTUS60W	03	GU 10	Max 10 W	W	D	ON/OFF	1	○

## TUBÌ CM

Code	Size	Lamp Type	Watt	K	Beam angle	Driver Type	Driver Nr.	Colour
YTUCM14W	01	GU 10	Max 10 W	W	D	ON/OFF	1	○
YTUCM40W	02	GU 10	Max 10 W	W	D	ON/OFF	1	○
YTUCM60W	03	GU 10	Max 10 W	W	D	ON/OFF	1	○

## ○ TUBÌ COLOUR SELECTION

- **SB** | Silver Bombalai
- **BL** | Bronze Lario
- **RR** | Rust Rame
- **BF** | Beige Futuna
- **WI** | White Irazu
- **GK** | Gold Karkar
- **BT** | Blue Telica
- **BLL** | Black Lava
- **CO** | Corten
- ▨ **PC** | Primer Coating

## TUBÌ BEAM ANGLE | DIMENSIONS



Size	X [mm]	Y [mm]	Z [mm]	Kg
<b>01</b>	ø 60	135	-	
<b>02</b>	ø 60	400	-	
<b>03</b>	ø 60	600	-	

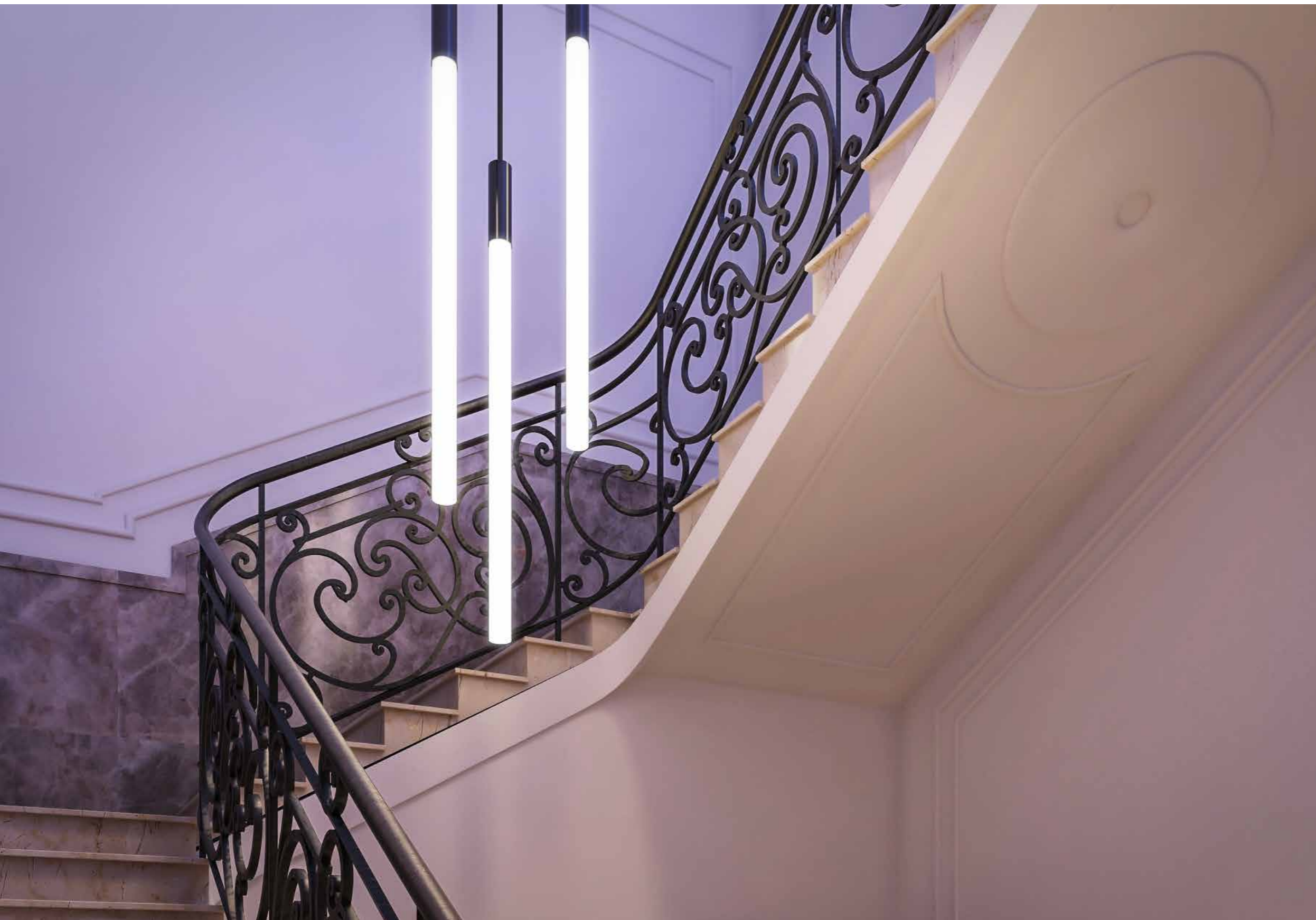

# Adalpina

## ADALPINA

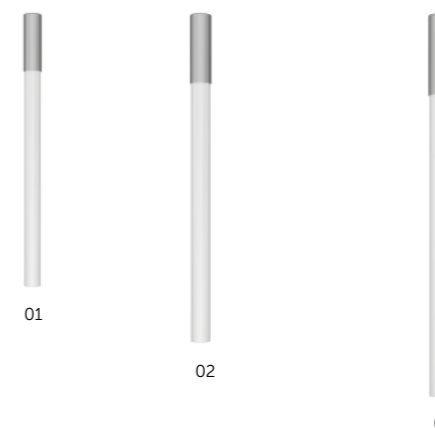

Suspension



| On request - p.XXX |

### IT

Apparecchio decorativo per installazione a sospensione. Vano alimentatore in alluminio estruso verniciato con polveri epossidiche antigraffio. Sorgente luminosa LED multichip. Corpo diffusore in policarbonato opale. completa di sospensione rigida Ø20 mm lunghezza 1 metro.

### ES

Luminaria decorativa de suspensión. Unidad de alimentación en aluminio extruido recubierta con polvo epoxi anti-rayado. Fuente de iluminación LED multichip. Cuerpo difusor de policarbonato opal. Completo de suspensión rígida Ø20 mm de longitud 1 metro.

### GB

Decorative suspension lighting fitting. Extruded aluminium power supply compartment painted with anti-scratch epoxy powder paint. Multichip LED lighting source. Opal polycarbonate diffuser. Complete with rigid suspension Ø20 mm 1 meter length.

### DE

Dekoratives Hängebeleuchtungsgerät. Feeder-Einheit aus extrudiertem Aluminium, lackiert mit kratzfestem Epoxidpulver. Multichip LED-Leuchtmittel. Diffusor Koerper aus opalem Polycarbonat. Komplett mit starren Federung Ø20 mm Länge 1 Meter.

### FR

Appareils décoratif en suspension. Unité d'alimentation en aluminium extrudé finition de peinture en poudre époxy anti-rayures. Source de lumière en LED multichip. Corps diffuseur en polycarbonate opale. Complet avec suspension rigide Ø20 mm longueur 1 mètre.

### RU

Xxxxx xxxxx

### ADALPINA

Code	Size	Lumen	Watt	K	Beam angle	Driver Type	Driver Nr.	Colour
YAD13W	01	5600	56	W	D	ON/OFF	1	○
YAD18W	02	8400	84	W	D	ON/OFF	1	○
YAD23W	03	11200	112	W	D	ON/OFF	1	○

### ADALPINA COLOUR SELECTION

- **SB** | Silver Bombalai
- **BL** | Bronze Lario
- **RR** | Rust Rame
- **BF** | Beige Futuna
- **WI** | White Irazu
- **GK** | Gold Karkar
- **BT** | Blue Telica
- **BLL** | Black Lava
- **CO** | Corten
- **PC** | Primer Coating

### ADALPINA BEAM ANGLE | DIMENSIONS

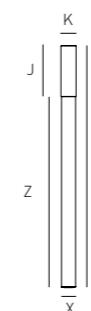

Size	X [mm]	Y [mm]	Z [mm]	J [mm]	K [mm]	Kg
<b>01</b>	ø 83	1350	1000	350	90	
<b>02</b>	ø 83	1850	1500	350	90	
<b>03</b>	ø 83	2350	2000	350	90	





Circo

# Circo

CIRCO

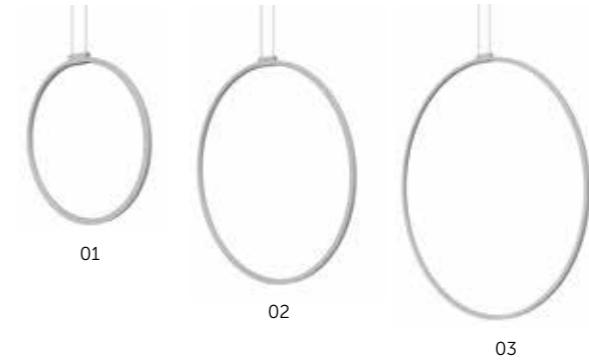

Suspension



| On request - p.XXX |

**IT**

Apparecchio decorativo per installazione a sospensione. Corpo in acciaio al carbonio calandrato. Sorgente luminosa LED multichip. Verniciatura con polveri epossidiche antigraffio. Schermo di chiusura in silicone opale.

**GB**

Decorative suspension lighting fitting. Calendered carbon steel body. Multichip LED lighting source. Anti-scratch epoxy powder paint finish. Opal silicone closing reflector.

**FR**

Appareils décoratif en suspension. Corps en acier au carbone calandré. Source de lumière en LED multichip. Finition de peinture en poudre époxy anti-rayures. Écran de fermeture en silicone opale.

**ES**

Luminaria decorativa de suspensión. Cuerpo en acero al carbono calandrado. Fuente de iluminación LED multichip. Recubierta con polvo epoxi anti-rayado. Difusor de silicona opal.

**DE**

Dekoratives Hängebeleuchtungsgerät. Körper aus kalandriertem Kohlenstoffstahl Multichip LED-Leuchtmittel. Lackierung mit kratzfesten Epoxypulvern. Abdeckschirm aus opalem Silikon.

**RU**

Xxxxx xxxx

**CIRCO**

Code	Size	Lumen	Watt	K	Beam angle	Driver Type	Driver Nr.	Colour
YANS32W	01	2400	29	W	D	ON/OFF	1	○
YANS48W	02	3600	36	W	D	ON/OFF	1	○
YANS64W	03	4800	58	W	D	ON/OFF	1	○

○ **CIRCO** COLOUR SELECTION

- **SB** | Silver Bombalai
- **BL** | Bronze Lario
- **RR** | Rust Rame
- **BF** | Beige Futuna
- **WI** | White Irazu
- **GK** | Gold Karkar
- **BT** | Blue Telica
- **BLL** | Black Lava
- **CO** | Corten
- **PC** | Primer Coating

**CIRCO** BEAM ANGLE | DIMENSIONS

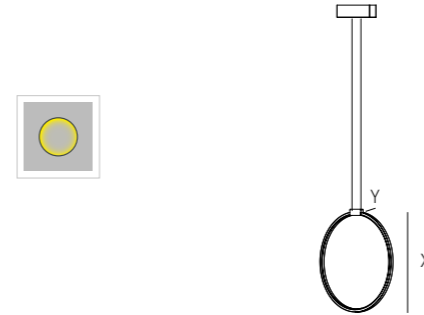

Size	X [mm]	Y [mm]	Z [mm]	Kg
<b>01</b>	ø 325	12	-	
<b>02</b>	ø 485	12	-	
<b>03</b>	ø 645	12	-	





# Olimpia

# OLIMPIA



## Suspension



| On request - p.XXX |

### IT

Apparecchio decorativo per installazione a sospensione. Base superiore in acciaio al carbonio pressopiegato. Sospensioni in acciaio al carbonio calandrato. Sorgente luminosa LED multichip. Verniciatura con polveri epossidiche antigraffio. Schermo di chiusura in silicone opale.

### ES

Luminaria decorativa de suspensión. Base superior en acero al carbono plegado. Suspensión en acero al carbono calandrado. Fuente de iluminación LED multichip. Recubierta con polvo epoxi anti-rayado. Difusor de silicona opal.

### GB

Decorative suspension lighting fitting. Bent carbon steel upper base. Calandered carbon steel suspensions. Multichip LED lighting source. Anti-scratch epoxy powder paint finish. Opal silicone closing reflector.

### DE

Dekoratives Hängebeleuchtungsgerät. Obere Basis aus pressgeformtem Kohlenstoffstahl. Suspensionen aus kalandriertem Kohlenstoffstahl. Multichip LED-Leuchtmittel. Lackierung mit kratzfesten Epoxypulvern. Abdeckschirm aus opalem Silikon.

### FR

Appareils décoratif en suspension. Base supérieure en acier au carbone courbé. Suspension en acier au carbone calandré. Source de lumière en LED multichip. Finition de peinture en poudre époxy anti-rayures. Écran de fermeture en silicone opale.

### RU

Xxxxx xxxx

## OLIMPIA

Code	Size	Lumen	Watt	K	Beam angle	Driver Type	Driver Nr.	Colour
YANL45W	01	4500	45	W	D	ON/OFF	1	○

## ○ OLIMPIA COLOUR SELECTION

- **SB** | Silver Bombalai
- **BL** | Bronze Lario
- **RR** | Rust Rame
- **BF** | Beige Futuna
- **WI** | White Irazu
- **GK** | Gold Karkar
- **BT** | Blue Telica
- **BLL** | Black Lava
- **CO** | Corten
- ▨ **PC** | Primer Coating

## OLIMPIA BEAM ANGLE | DIMENSIONS

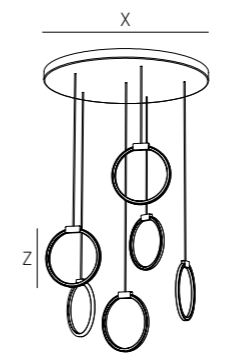

Size	X [mm]	Y [mm]	Z [mm]	Kg
01	ø 550	max 2000	ø 165	



# Libora

# Libra

# LIBRA



## Suspension



| On request - p.XXX |

### IT

Apparecchio decorativo per installazione a sospensione. Base superiore in acciaio al carbonio pressopiegato. Sospensioni in acciaio al carbonio calandrato. Sorgente luminosa LED multichip. Verniciatura con polveri epossidiche antigraffio. Schermo di chiusura in silicone opale.

### ES

Luminarias decorativas de suspensión. Carcasa en aluminio torneado. Fuente de iluminación LED multichip. Recubierta con polvo epoxi anti-rayado. Difusor de policarbonato opal.

### GB

Decorative suspension lighting fitting. Turned aluminum body. Multichip LED lighting source. Anti-scratch epoxy powder paint finish. Opal polycarbonate closing reflector.

### DE

Xxxxx xxxxx

### FR

Appareils décoratif en suspension. Corps en aluminium tourné. Source de lumière en LED multichip. Finition de peinture en poudre époxy anti-rayures. Écran de fermeture en polycarbonate opale.

### RU

Xxxxx xxxx

## LIBRA

Code	Size	Lumen	Watt	K	Beam angle	Driver Type	Driver Nr.	Colour
	01	2740	21	W	D	ON/OFF	1	○
	01	3650	29	W	D	ON/OFF	1	○

## LIBRA COLOUR SELECTION

- **SB** | Silver Bombalai
- **BL** | Bronze Lario
- **RR** | Rust Rame
- **BF** | Beige Futuna
- **WI** | White Irazu
- **GK** | Gold Karkar
- **BT** | Blue Telica
- **BLL** | Black Lava
- **CO** | Corten
- ▨ **PC** | Primer Coating

74  
75

## LIBRA BEAM ANGLE | DIMENSIONS



Size	X [mm]	Y [mm]	Z [mm]	Kg
<b>01</b>	ø 550	max 2000	ø 165	

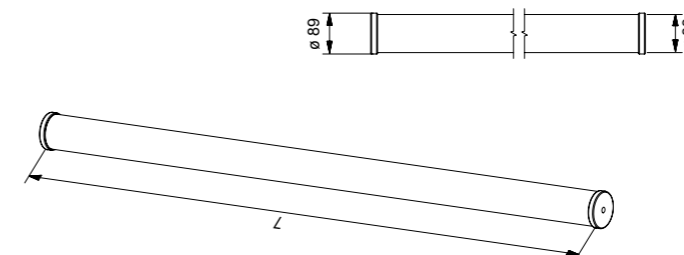





rain



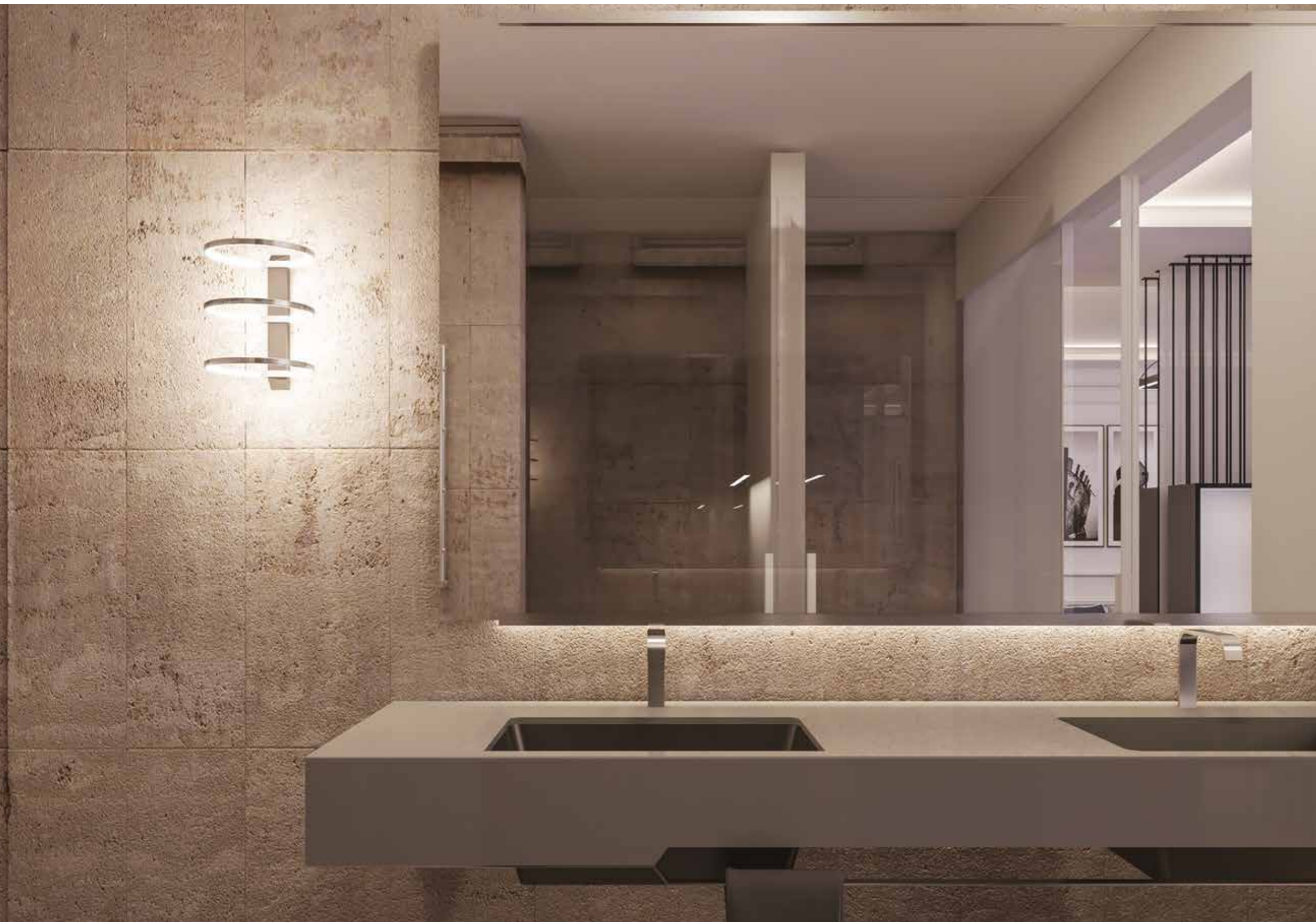

# Stargate

## STARGATE



Wall Mounted



| On request - p.XXX |

### IT

Apparecchio decorativo per installazione a parete. Corpo in acciaio al carbonio calandrato e pressopiegato. Sorgente luminosa LED multichip. Verniciatura con polveri epossidiche antigraffio. Schermo di chiusura in silicone opalino

### GB

Decorative lighting fixture for wall installation. Bent carbon steel body. Multichip LED lighting source. Anti-scratch epoxy powder paint finish. Opal polycarbonate closing reflector.

### FR

Appareils décoratif pour l'installation sur le mur. Corps en acier au carbone courbé et calandré. Source de lumière en LED multichip. Finition de peinture en poudre époxy anti-rayures. Écran de fermeture en silicone opale.

### ES

Luminaria decorativa para instalación en pared. Cuerpo de acero al carbono plegado y calandrado. Fuente de iluminación LED multichip. Recubierta con polvo epoxi anti-rayado. Difusor de silicona opal.

### DE

Dekoratives Wandbeleuchtungsgerät. Körper aus kalandriertem und pressgeformtem Kohlenstoffstahl. Multichip LED-Leuchtmittel. Lackierung mit kratzfesten Epoxypulvern. Abdeckschirm aus opalem Silikon.

### RU

Xxxx xxxx xxxx

### STARGATE

Code	Size	Lumen	Watt	K	Beam angle	Driver Type	Driver Nr.	Colour
YST324W	01	2400	24	W	D	ON/OFF	1	○

### ○ STARGATE COLOUR SELECTION

- **SB** | Silver Bombalai
- **BL** | Bronze Lario
- **RR** | Rust Rame
- **BF** | Beige Futuna
- **WI** | White Irazu
- **GK** | Gold Karkar
- **BT** | Blue Telica
- **BLL** | Black Lava
- **CO** | Corten
- **PC** | Primer Coating

### STARGATE BEAM ANGLE | DIMENSIONS

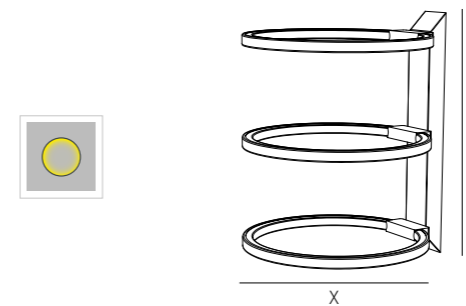

Size	X [mm]	Y [mm]	Z [mm]	Kg
A	Ø 165	260	-	





Alboa

# Alba

ALBA



Wall Mounted



| On request - p.XXX |

**IT**

Apparecchio decorativo per installazione a parete. Corpo in acciaio al carbonio calandrato e pressopiegato. Sorgente luminosa LED multichip. Verniciatura con polveri epossidiche antigraffio. Schermo di chiusura in silicone opalino.

**GB**

Decorative lighting fitting for wall installation. Bent and calendered carbon steel body. Multichip LED lighting source. Anti-scratch epoxy powder paint finish. Opal silicone closing reflector.

**FR**

Appareils décoratif pour l'installation sur le mur. Corps en acier au carbone courbé et calandré. Source de lumière en LED multichip. Finition de peinture en poudre époxy anti-rayures. Écran de fermeture en silicone opale.

**ES**

Luminaria decorativa para instalación en pared. Cuerpo de acero al carbono plegado y calandrado. Fuente de iluminación LED multichip. Recubierta con polvo epoxi anti-rayado. Difusor de silicona opal.

**DE**

Dekoratives Wandbeleuchtungsgerät. Körper aus kalandriertem und pressgeformtem Kohlenstoffstahl. Multichip LED-Leuchtmittel. Lackierung mit kratzfesten Epoxypulvern. Abdeckschirm aus opalem Silikon.

**RU**

Xxxx xxxx xxxx

**ALBA**

Code	Size	Lumen	Watt	K	Beam angle	Driver Type	Driver Nr.	Colour
YANA25W	01	1800	24	W	D	ON/OFF	1	○

○ **ALBA** COLOUR SELECTION

- **SB** | Silver Bombalai
- **BL** | Bronze Lario
- **RR** | Rust Rame
- **BF** | Beige Futuna
- **WI** | White Irazu
- **GK** | Gold Karkar
- **BT** | Blue Telica
- **BLL** | Black Lava
- **CO** | Corten
- **PC** | Primer Coating

**ALBA** BEAM ANGLE | DIMENSIONS

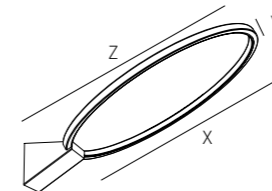

Size	X [mm]	Y [mm]	Z [mm]	Kg
A	Ø 250	12	280	



Tink



# Tink

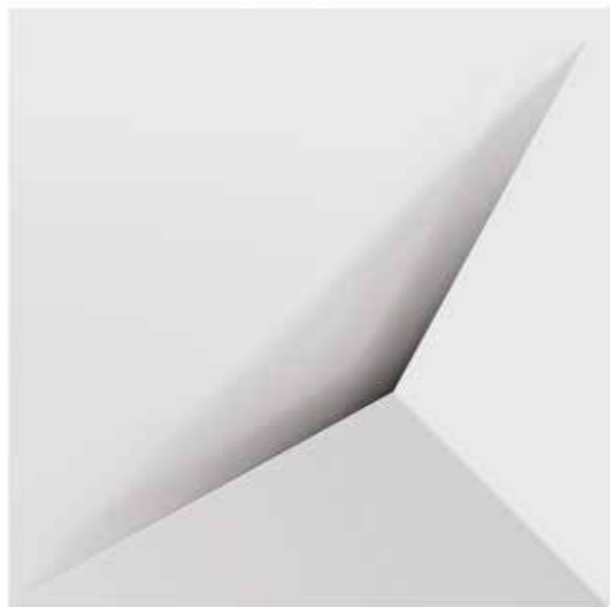

Wall Mounted

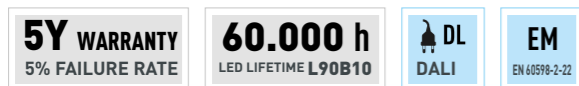

| On request - p.XXX |

**IT**

Apparecchio decorativo per installazione a parete. Corpo in acciaio al carbonio pressopiegato. Sorgente luminosa LED multichip. Verniciatura con polveri epossidiche antigraffio. Schermo di chiusura in policarbonato opalino

**ES**

Luminaria decorativa para instalación en pared. Cuerpo de acero al carbono plegado. Fuente de iluminación LED multichip. Recubierta con polvo epoxi anti-rayado. Difusor de policarbonato opal.

**GB**

Decorative lighting fitting for wall installation. Bent carbon steel body. Multichip LED lighting source. Anti-scratch epoxy powder paint finish. Opal polycarbonate closing reflector.

**DE**

Dekoratives Wandbeleuchtungsgerät. Körper aus pressgeformtem Kohlenstoffstahl Multichip LED-Leuchtmittel. Lackierung mit kratzfesten Epoxypulvern. Abdeckschirm aus opalem Polycarbonat.

**FR**

Appareils décoratif pour l'installation sur le mur. Corps en acier au carbone courbé. Source de lumière en LED multichip. Finition de peinture en poudre époxy anti-rayures. Écran de fermeture en polycarbonate opale.

**RU**

Xxxx xxxx xxxx

TINK

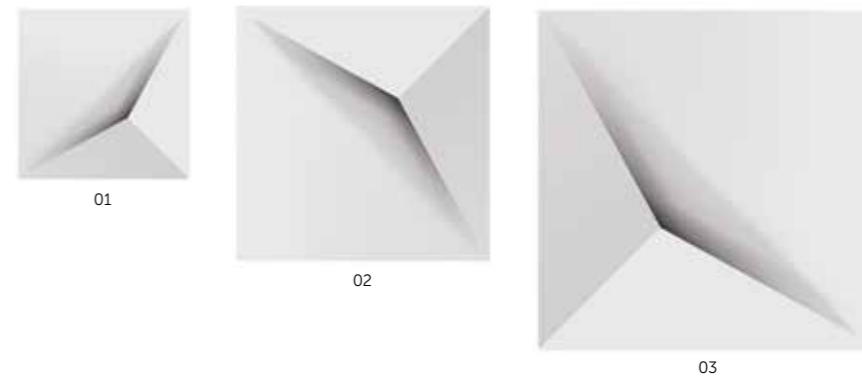

**TINK** VARIO **LUMEN** | VARIO **KELVIN**

Code	Size	Vario Lumen	Watt	K	Beam angle	Driver Type	Driver Nr.	Colour
YT122VKLW	01	1570   2350   3150	11   16   21	Vario	D	ON/OFF	1	○
YT130VKLW	02	2850   4270   5700	19   29   38	Vario	D	ON/OFF	2	○
YT50VKLW	03	4380   6580   8770	29   44   58	Vario	D	ON/OFF	4	○

**TINK**

Code	Size	Lumen	Watt	K	Beam angle	Driver Type	Driver Nr.	Colour
YT122	01	3150	21	W	D	ON/OFF	1	○
YT130	02	5700	38	W	D	ON/OFF	2	○
YT150	03	8770	58	W	D	ON/OFF	4	○

○ **TINK** COLOUR SELECTION

- **SB** | Silver Bombalai
- **BL** | Bronze Lario
- **RR** | Rust Rame
- **BF** | Beige Futuna
- **WI** | White Irazu
- **GK** | Gold Karkar
- **BT** | Blue Telica
- **BLL** | Black Lava
- **CO** | Corten
- **PC** | Primer Coating

**TINK** BEAM ANGLE | DIMENSIONS

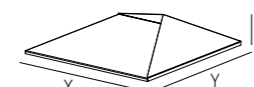

Size	X [mm]	Y [mm]	Z [mm]	Kg
<b>01</b>	220	220	70	
<b>02</b>	300	300	85	
<b>03</b>	500	500	130	



# Faces

## FACES



Wall Mounted



### IT

Apparecchio decorativo per installazione a parete. Corpo in acciaio al carbonio pressopiegato. Sorgente luminosa LED multichip. Verniciatura con polveri epossidiche antigraffio. Schermo di chiusura in policarbonato opalino.

### ES

Luminaria decorativa para instalación en pared. Cuerpo de acero al carbono plegado. Fuente de iluminación LED multichip. Recubierta con polvo epoxi anti-rayado. Difusor de policarbonato opal.

### GB

Decorative lighting fitting for wall installation. Bent carbon steel body. Multichip LED lighting source. Anti-scratch epoxy powder paint finish. Opal polycarbonate closing reflector.

### DE

Dekoratives Wandbeleuchtungsgerät. Körper aus pressgeformtem Kohlenstoffstahl. Multichip LED-Leuchtmittel. Lackierung mit kratzfesten Epoxypulvern. Abdeckschirm aus opalem Polycarbonat.

### FR

Appareils décoratif pour l'installation sur le mur. Corps en acier au carbone courbé. Source de lumière en LED multichip. Finition de peinture en poudre époxy anti-rayures. Écran de fermeture en polycarbonate opale.

### RU

Xxxx xxxx xxxx

### FACES

Code	Size	Lumen	Watt	K	Beam angle	Driver Type	Driver Nr.	Colour
YFA26W	01	2400	26	W	D	ON/OFF	1	○

### ○ FACES COLOUR SELECTION

- **SB** | Silver Bombalai
- **BL** | Bronze Lario
- **RR** | Rust Rame
- **BF** | Beige Futuna
- **WI** | White Irazu
- **GK** | Gold Karkar
- **BT** | Blue Telica
- **BLL** | Black Lava
- **CO** | Corten
- **PC** | Primer Coating

### FACES BEAM ANGLE | DIMENSIONS

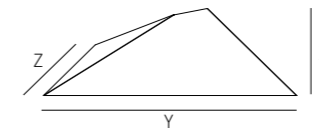

Size	X [mm]	Y [mm]	Z [mm]	Kg
A	145	600	115	





# Calea

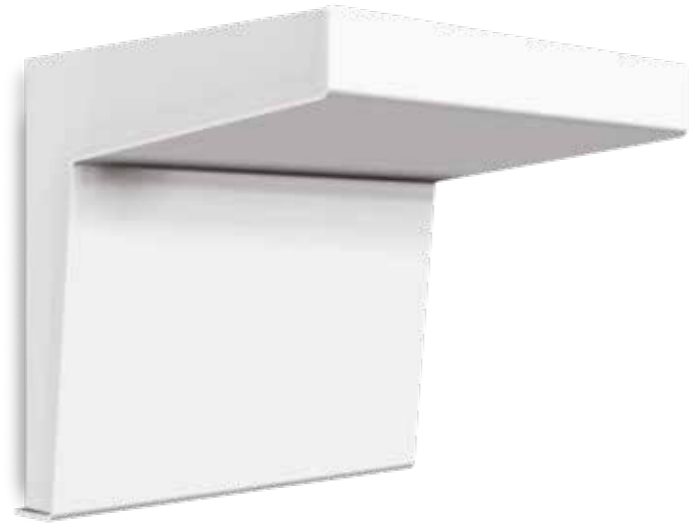

# CALEA



## Wall Mounted



| On request - p.XXX |

### IT

Apparecchio decorativo per installazione a parete. Corpo in acciaio al carbonio pressopiegato. Sorgente luminosa LED multichip. Verniciatura con polveri epossidiche antigraffio. Schermo di chiusura in policarbonato trasparente.

### ES

Luminaria decorativa para instalación en pared. Cuerpo de acero al carbono plegado. Fuente de iluminación LED multichip. Recubierta con polvo epoxi anti-rayado. Difusor de policarbonato transparente.

### GB

Decorative lighting fitting for wall installation. Bent carbon steel body. Multichip LED lighting source. Anti-scratch epoxy powder paint finish. Opal polycarbonate closing reflector.

### DE

Dekoratives Wandbeleuchtungsgerät. Körper aus pressgeformtem Kohlenstoffstahl. Multichip LED-Leuchtmittel. Lackierung mit kratzfesten Epoxypulvern. Abdeckschirm aus opalem Polycarbonat.

### FR

Luminaire décoratif pour l'installation sur le mur. Corps en acier au carbone courbé. Source de lumière en LED multichip. Finition de peinture en poudre époxy anti-rayures. Écran de fermeture en polycarbonate transparent.

### RU

Xxxx xxxx xxxx

## CALEA VARIO LUMEN | VARIO KELVIN

Code	Size	Vario Lumen	Watt	K	Beam angle	Driver Type	Driver Nr.	Colour
YCA21VKLW	01	3600   5400   7200	27   40   53	Vario	D	ON/OFF	1	○
YCA41VKLW	02	7200   10800   14400	53   80   106	Vario	D	ON/OFF	2	○
YCA61VKLW	03	10800   16200   21600	80   120   159	Vario	D	ON/OFF	3	○

## CALEA

Code	Size	Lumen	Watt	K	Beam angle	Driver Type	Driver Nr.	Colour
YCA21W	01	7200	53	W	D	ON/OFF	1	○
YCA41W	02	14400	106	W	D	ON/OFF	2	○
YCA61W	03	21600	159	W	D	ON/OFF	3	○

## ○ CALEA COLOUR SELECTION

- SB | Silver Bombalai
- BL | Bronze Lario
- RR | Rust Rame
- BF | Beige Futuna
- WI | White Irazu
- GK | Gold Karkar
- BT | Blue Telica
- BLL | Black Lava
- CO | Corten
- PC | Primer Coating

## CALEA BEAM ANGLE | DIMENSIONS

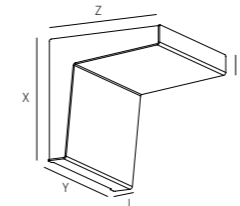

Size	X [mm]	Y [mm]	Z [mm]	J [mm]	K [mm]	Kg
01	183	210	183	26	26	
02	183	410	183	26	26	
03	183	610	183	26	26	

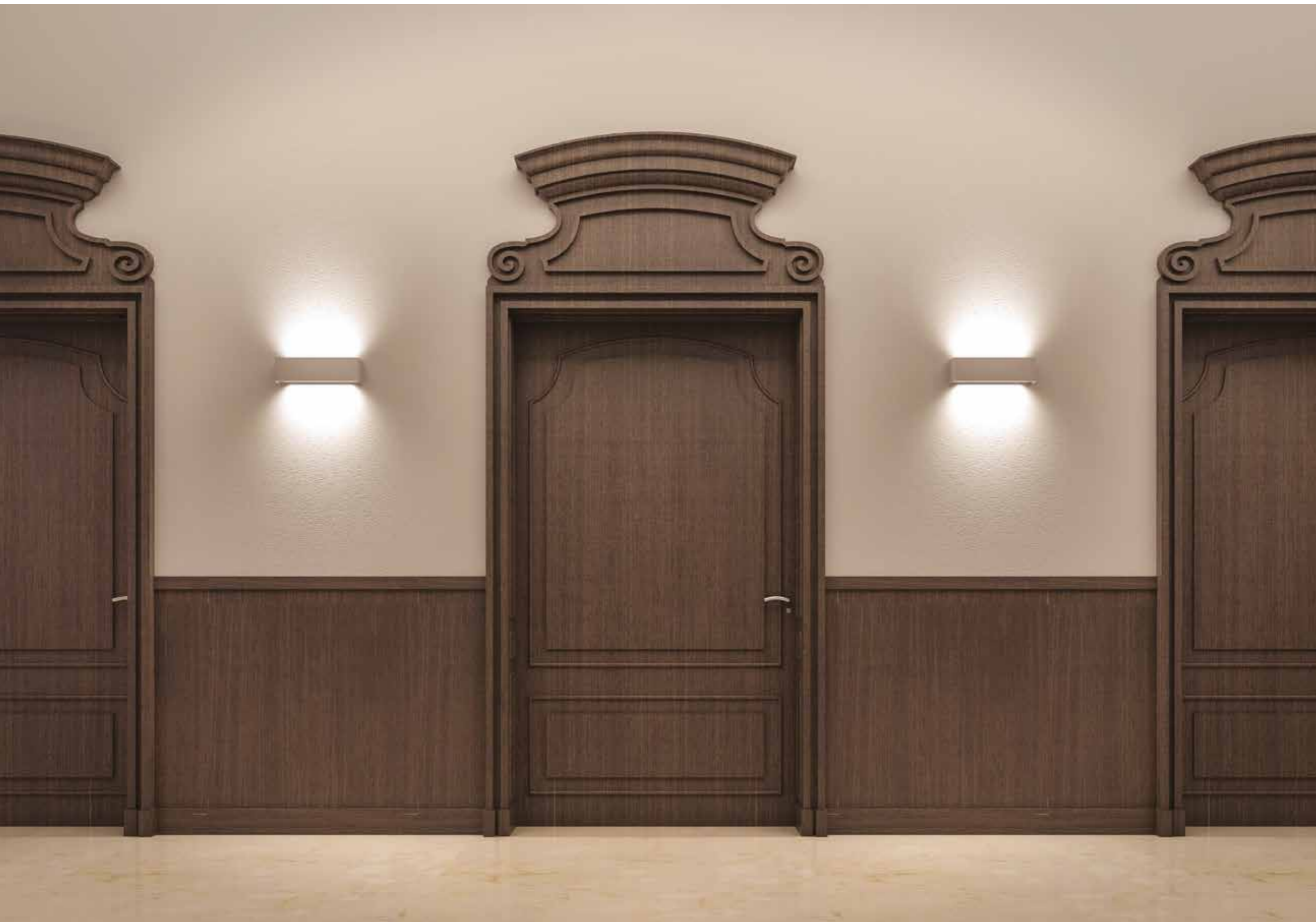



Zoe



ZOE



Wall Mounted



| On request - p.XXX |

**IT**

Apparecchio decorativo per installazione a parete. Corpo in acciaio al carbonio pressopiegato intercambiabile con fissaggio magnetico. Sorgente luminosa LED multichip. Verniciatura con polveri epossidiche antigraffio. Schermo di chiusura in policarbonato opalino.

**ES**

Luminaria decorativa para instalación en pared. Cuerpo de acero al carbono plegado intercambiable con fijación magnética. Fuente de iluminación LED multichip. Recubierta con polvo epoxi anti-rayado. Difusor de policarbonato opal.

**GB**

Decorative lighting fitting for wall installation. Bent carbon steel body, interchangeable with magnetic fixing Multichip LED lighting source. Anti-scratch epoxy powder paint finish. Opal polycarbonate closing reflector.

**DE**

Dekoratives Wandbeleuchtungsgerät. Körper aus pressgeformtem Kohlenstoffstahl austauschbar mit Magnetbefestigung. Multichip LED-Leuchtmittel. Lackierung mit kratzfesten Epoxypulvern. Abdeckschirm aus opalem Polycarbonat.

**FR**

Appareils décoratif pour l'installation sur le mur. Corps en acier au carbone courbé interchangeable avec fixation magnétique. Source de lumière en LED multichip. Finition de peinture en poudre époxy anti-rayures. Écran de fermeture en polycarbonate opale.

**RU**

Xxxx xxxx xxxx

**ZOE** VARIO *LUMEN* | VARIO *KELVIN*

Code	Size	Vario Lumen	Watt	K	Beam angle	Driver Type	Driver Nr.	Colour
YZO23VKLW	01	1570   2350   3150	11   16   21	Vario	D	ON/OFF	1	○
YZO45VKLW	02	1820   2480   3570	12   18   20	Vario	D	ON/OFF	1	○

**ZOE**

Code	Size	Lumen	Watt	K	Beam angle	Driver Type	Driver Nr.	Colour
YZO23W	01	3150	21	W	D	ON/OFF	1	○
YZO45W	02	4000	27	W	D	ON/OFF	1	○
YZO60W	03	8450	57	W	D	ON/OFF	1	○

100  
101

○ **ZOE** COLOUR SELECTION

- **SB** | Silver Bombalai
- **BL** | Bronze Lario
- **RR** | Rust Rame
- **BF** | Beige Futuna
- **WI** | White Irazu
- **GK** | Gold Karkar
- **BT** | Blue Telica
- **BLL** | Black Lava
- **CO** | Corten
- ▨ **PC** | Primer Coating

**ZOE** BEAM ANGLE | DIMENSIONS

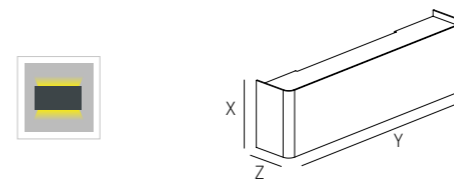

Size	X [mm]	Y [mm]	Z [mm]	Kg
<b>01</b>	115	225	70	
<b>02</b>	115	395	70	
<b>03</b>	115	595	70	



Talé

# Talé



Wall Mounted



| On request - p.XXX |

## IT

Apparecchio decorativo per installazione a parete. Corpo in acciaio al carbonio pressopiegato. Sorgente luminosa LED multichip. Verniciatura con polveri epossidiche antigraffio. Schermo di chiusura in policarbonato opalino

## ES

Luminaria decorativa para instalación en pared. Cuerpo de acero al carbono plegado. Fuente de iluminación LED multichip. Recubierta con polvo epoxi anti-rayado. Difusor de policarbonato opal.

## GB

Decorative lighting fitting for wall installation. Bent carbon steel body. Multichip LED lighting source. Anti-scratch epoxy powder paint finish. Opal polycarbonate closing reflector.

## DE

Dekoratives Wandbeleuchtungsgerät. Körper aus pressgeformtem Kohlenstoffstahl Multichip LED-Leuchtmittel. Lackierung mit kratzfesten Epoxypulvern. Abdeckschirm aus opalem Polycarbonat.

## FR

Appareils décoratif pour l'installation sur le mur. Corps en acier au carbone courbé. Source de lumière en LED multichip. Finition de peinture en poudre époxy anti-rayures. Écran de fermeture en polycarbonate opale.

## RU

Xxxx xxxx xxxx

# TALÉ

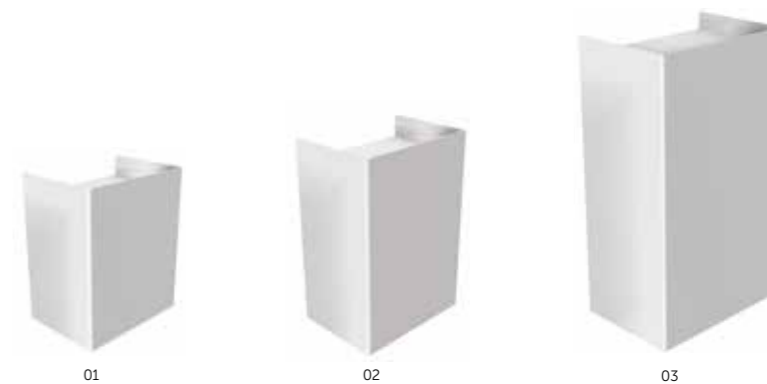

## TALÉ VARIO LUMEN | VARIO KELVIN

Code	Size	Vario Lumen	Watt	K	Beam angle	Driver Type	Driver Nr.	Colour
YTA15VKLW	01	1620   2430   3240	11   16   21	Vario	D	ON/OFF	1	○
YTA18VKLW	02	2150   3250   4300	15   23   30	Vario	D	ON/OFF	1	○
YTA33VKLW	03	3240   4860   6480	22   33   44	Vario	D	ON/OFF	1	○

## TALÉ

Code	Size	Lumen	Watt	K	Beam angle	Driver Type	Driver Nr.	Colour
YTA15W	01	3100	21	W	D	ON/OFF	1	○
YTA18W	02	5000	33	W	D	ON/OFF	1	○
YTA33W	03	7000	45	W	D	ON/OFF	1	○

## ○ TALÉ COLOUR SELECTION

- SB | Silver Bombalai
- BL | Bronze Lario
- RR | Rust Rame
- BF | Beige Futuna
- WI | White Irazu
- GK | Gold Karkar
- BT | Blue Telica
- BLL | Black Lava
- CO | Corten
- PC | Primer Coating

## TALÉ BEAM ANGLE | DIMENSIONS

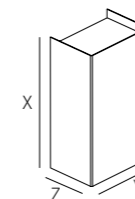

Size	X [mm]	Y [mm]	Z [mm]	Kg
01	145	120	85	
02	175	120	85	
03	325	180	125	





# Ester

# Esten

# ESTER



Wall Mounted  
Celing Mounted

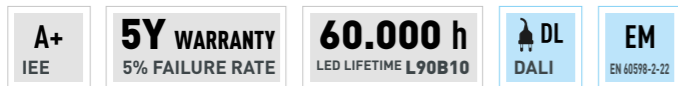

| On request - p.XXX |

## IT

Apparecchio decorativo per installazione a parete o plafone. Corpo in alluminio estruso. Sorgente luminosa LED multichip. Verniciatura con polveri epossidiche antigraffio. Schermo di chiusura in policarbonato opalino.

## ES

Luminaria decorativa para instalación en pared y techo. Cuerpo de aluminio extruido. Fuente de iluminación LED multichip. Recubierta con polvo epoxi anti-rayado. Difusor de policarbonato opal.

## GB

Decorative lighting fitting for wall or ceiling installation. Extruded aluminium body. Multichip LED lighting source. Anti-scratch epoxy powder paint finish. Opal polycarbonate closing reflector.

## DE

Dekoratives Wand- und Deckenbeleuchtungsgerät. Körper aus extrudiertem Aluminium Multichip LED-Leuchtmittel. Lackierung mit kratzfesten Epoxypulvern. Abdeckschirm aus opalem Polycarbonat.

## FR

Appareils décoratif pour l'installation sur le mur ou plafond. Corps en aluminium extrudé. Source de lumière en LED multichip. Finition de peinture en poudre époxy anti-rayures. Écran de fermeture en polycarbonate opale.

## RU

Xxxx xxxx xxxx



01

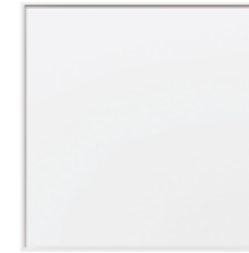

02

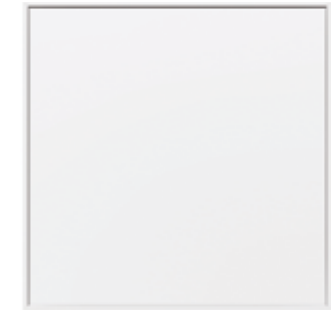

03

## ESTER

Code	Size	Lumen	Watt	K	Beam angle	Driver Type	Driver Nr.	Colour
YES40W	01	1500	11	W	D	ON/OFF	1	○
YES60W	02	5400	40	W	D	ON/OFF	1	○
YES90W	03	9800	70	W	D	ON/OFF	2	○

## ESTER COLOUR SELECTION

- **SB** | Silver Bombalai
- **BL** | Bronze Lario
- **RR** | Rust Rame
- **BF** | Beige Futura
- **WI** | White Irazu
- **GK** | Gold Karkar
- **BT** | Blue Telica
- **BLL** | Black Lava
- **CO** | Corten
- **PC** | Primer Coating

## ESTER BEAM ANGLE | DIMENSIONS

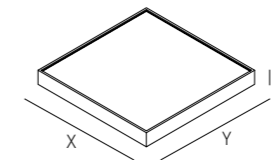

Size	X [mm]	Y [mm]	Z [mm]	Kg
01	400	400	55	
02	600	600	55	
03	900	900	55	

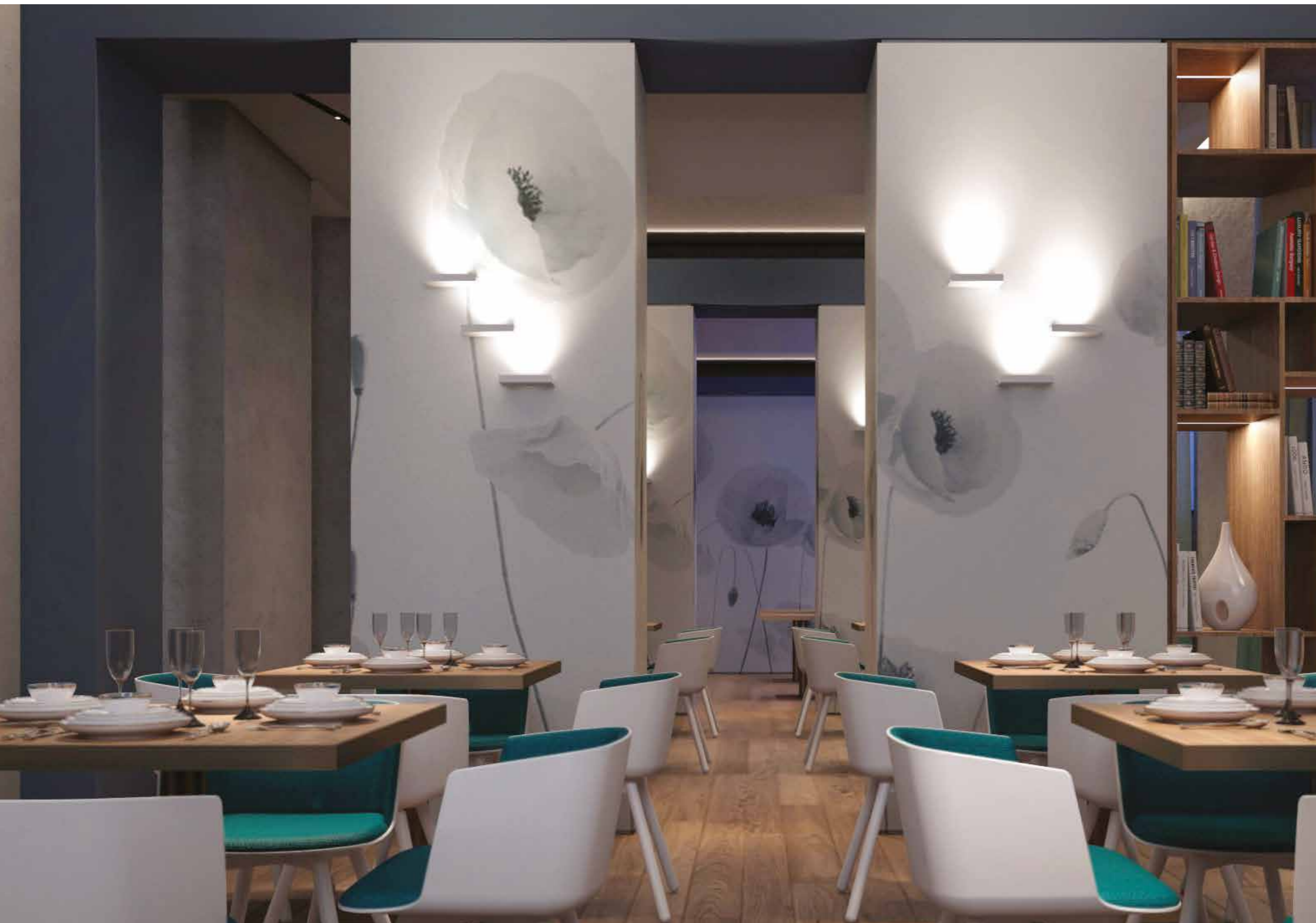

Duodu



# Dudu

# DUDU

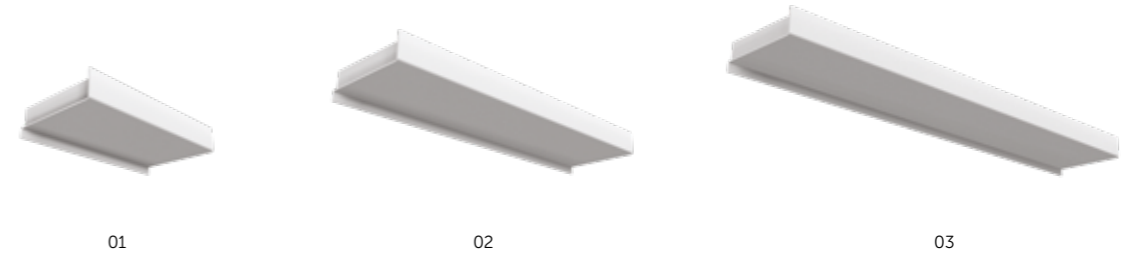

Wall Mounted



| On request - p.XXX |

**IT**  
Apparecchio decorativo per installazione a parete. Corpo in acciaio al carbonio pressopiegato. Sorgente luminosa LED multichip. Verniciatura con polveri epossidiche antigraffio.

**GB**  
Decorative lighting fitting for wall installation. Bent carbon steel body. Multichip LED lighting source. Anti-scratch epoxy powder paint finish.

**FR**  
Appareils décoratif pour l'installation sur le mur. Corps en acier au carbone courbé. Source de lumière en LED multichip. Finition de peinture en poudre époxy anti-rayures.

**ES**  
Luminaria decorativa para instalación en pared. Cuerpo de acero al carbono plegado. Fuente de iluminación LED multichip. Recubierta con polvo epoxi anti-rayado.

**DE**  
Dekoratives Wandbeleuchtungsgerät. Körper aus pressgeformtem Kohlenstoffstahl Multichip LED-Leuchtmittel. Lackierung mit kratzfesten Epoxypulvern.

**RU**  
Xxxx xxxx xxxx

## DUDU

Code	Size	Lumen	Watt	K	Beam angle	Driver Type	Driver Nr.	Colour
YDU23W	01	3150	21	W	D	ON/OFF	1	○
YDU40W	02	3900	23	W	D	ON/OFF	1	○
YDU60W	03	4200	28	W	D	ON/OFF	1	○

## ○ DUDU COLOUR SELECTION

- **SB** | Silver Bombalai
- **BL** | Bronze Lario
- **RR** | Rust Rame
- **BF** | Beige Futuna
- **WI** | White Irazu
- **GK** | Gold Karkar
- **BT** | Blue Telica
- **BLL** | Black Lava
- **CO** | Corten
- ▨ **PC** | Primer Coating

## DUDU BEAM ANGLE | DIMENSIONS

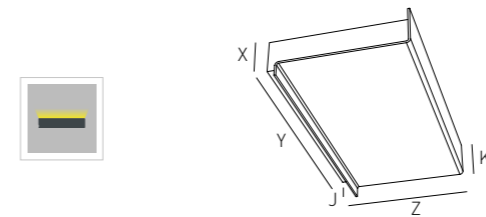

Size	X [mm]	Y [mm]	Z [mm]	J [mm]	K [mm]	Kg
<b>01</b>	40	230	110	10	30	
<b>02</b>	40	395	110	10	30	
<b>03</b>	40	595	110	20	30	



# Dosi

# DOSI

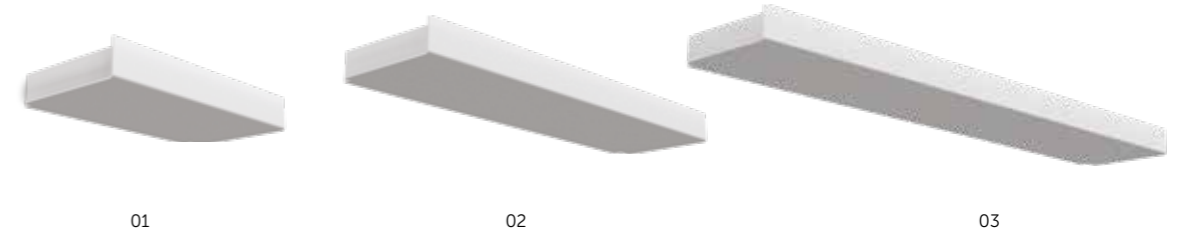

Wall Mounted



| On request - p.XXX |

**IT**

Apparecchio decorativo per installazione a parete. Corpo in acciaio al carbonio pressopiegato. Sorgente luminosa LED multichip. Verniciatura con polveri epossidiche antigraffio.

**GB**

Decorative lighting fitting for wall installation. Bent carbon steel body. Multichip LED lighting source. Anti-scratch epoxy powder paint finish.

**FR**

Appareils décoratif pour l'installation sur le mur. Corps en acier au carbone courbé. Source de lumière en LED multichip. Finition de peinture en poudre époxy anti-rayures.

**ES**

Luminaria decorativa para instalación en pared. Cuerpo de acero al carbono plegado. Fuente de iluminación LED multichip. Recubierta con polvo epoxi anti-rayado.

**DE**

Dekoratives Wandbeleuchtungsgerät. Körper aus pressgeformtem Kohlenstoffstahl Multichip LED-Leuchtmittel. Lackierung mit kratzfesten Epoxypulvern.

**RU**

Xxxx xxxx xxxx

## DOSI

Code	Size	Lumen	Watt	K	Beam angle	Driver Type	Driver Nr.	Colour
YDO23W	01	3150	21	W	D	ON/OFF	1	○
YDO40W	02	3900	23	W	D	ON/OFF	1	○
YDO60W	03	4200	28	W	D	ON/OFF	1	○

## DOSI COLOUR SELECTION

- **SB** | Silver Bombalai
- **BL** | Bronze Lario
- **RR** | Rust Rame
- **BF** | Beige Futuna
- **WI** | White Irazu
- **GK** | Gold Karkar
- **BT** | Blue Telica
- **BLL** | Black Lava
- **CO** | Corten
- ▨ **PC** | Primer Coating

## DOSI BEAM ANGLE | DIMENSIONS

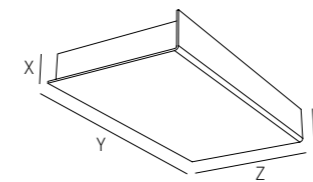

Size	X [mm]	Y [mm]	Z [mm]	J [mm]	Kg
<b>01</b>	40	230	110	30	
<b>02</b>	40	395	110	30	
<b>03</b>	40	595	110	30	



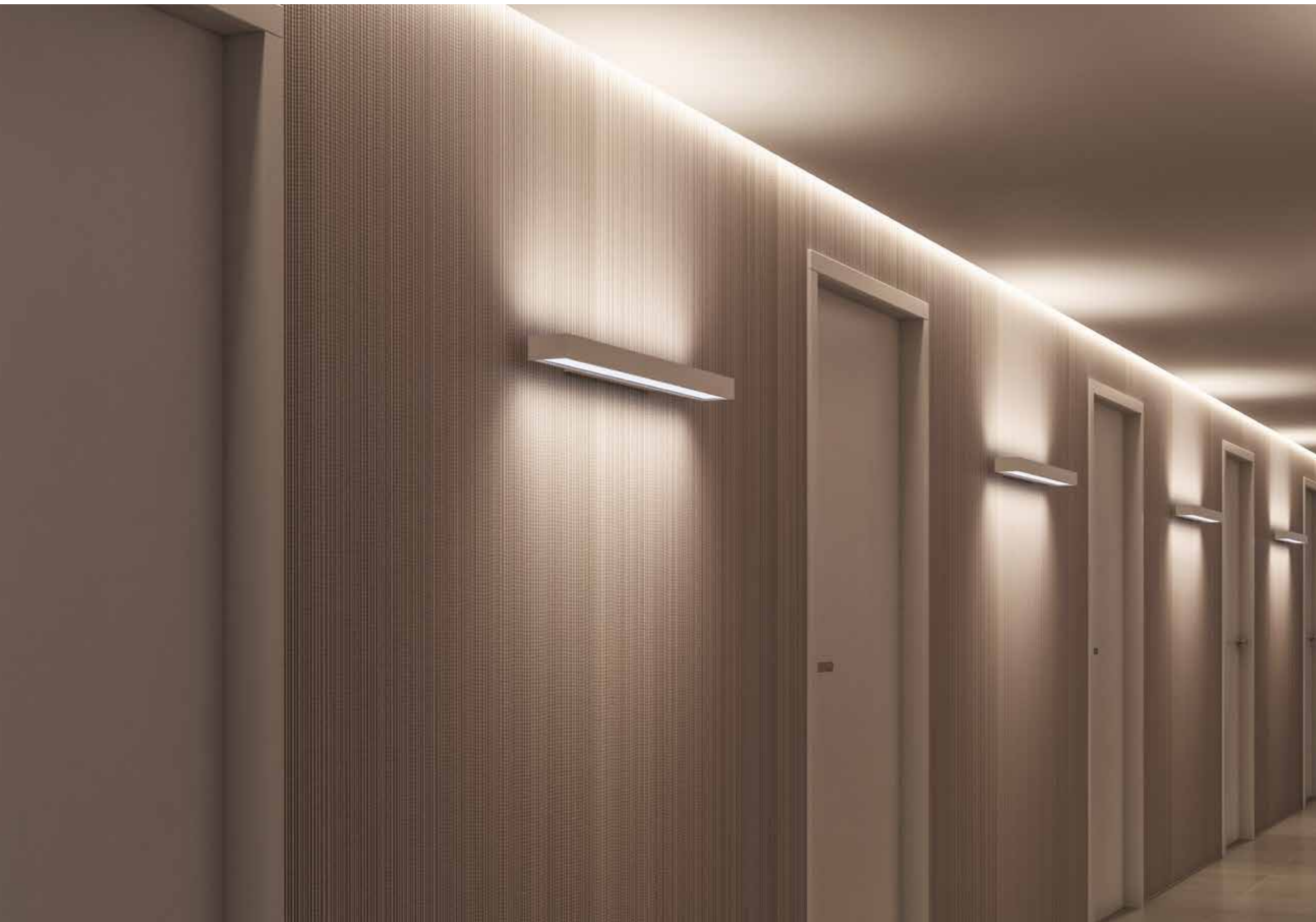

Gina

# Gina

GINA

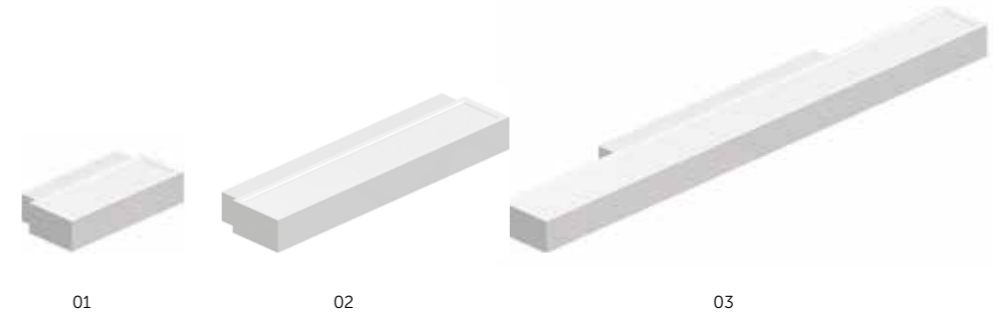

## GINA

Code	Size	Lumen	Watt	K	Beam angle	Driver Type	Driver Nr.	Colour
YGI18W	01	1080	8	W	D	ON/OFF	1	○
YGI41W	02	3250	22	W	D	ON/OFF	1	○
YGI80W	03	8400	49	W	D	ON/OFF	1	○

Wall Mounted



| On request - p.XXX |

### IT

Apparecchio decorativo per installazione a parete. Corpo in alluminio estruso. Sorgente luminosa LED multichip. Verniciatura con polveri epossidiche antigraffio. Schermo di chiusura in policarbonato opalino.

### GB

Decorative lighting fitting for wall installation. Extruded aluminium body. Multichip LED lighting source. Anti-scratch epoxy powder paint finish. Opal polycarbonate closing reflector.

### FR

Appareils décoratif pour l'installation sur le mur. Corps en aluminium extrudé. Source de lumière en LED multichip. Finition de peinture en poudre époxy anti-rayures. Écran de fermeture en polycarbonate opale.

### ES

Luminaria decorativa para instalación en pared. Cuerpo de aluminio extruido. Fuente de iluminación LED multichip. Recubierta con polvo epoxi anti-rayado. Difusor de policarbonato opal.

### DE

Dekoratives Wandbeleuchtungsgerät. Körper aus extrudiertem Aluminium. Multichip LED-Leuchtmittel. Lackierung mit kratzfesten Epoxypulvern. Abdeckschirm aus opalem Polycarbonat.

### RU

Xxxx xxxx xxxx

## GINA COLOUR SELECTION

- **SB** | Silver Bombalai
- **BL** | Bronze Lario
- **RR** | Rust Rame
- **BF** | Beige Futuna
- **WI** | White Irazu
- **GK** | Gold Karkar
- **BT** | Blue Telica
- **BLL** | Black Lava
- **CO** | Corten
- ▨ **PC** | Primer Coating

## GINA BEAM ANGLE | DIMENSIONS

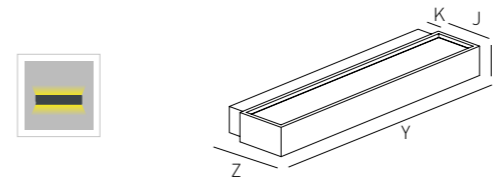

Size	X [mm]	Y [mm]	Z [mm]	K [mm]	J [mm]	Kg
<b>01</b>	45	180	110	30	80	
<b>02</b>	45	410	110	30	80	
<b>03</b>	45	800	110	30	80	



# Mali



# Mali

# MALÌ

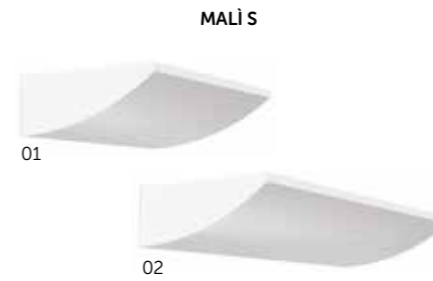
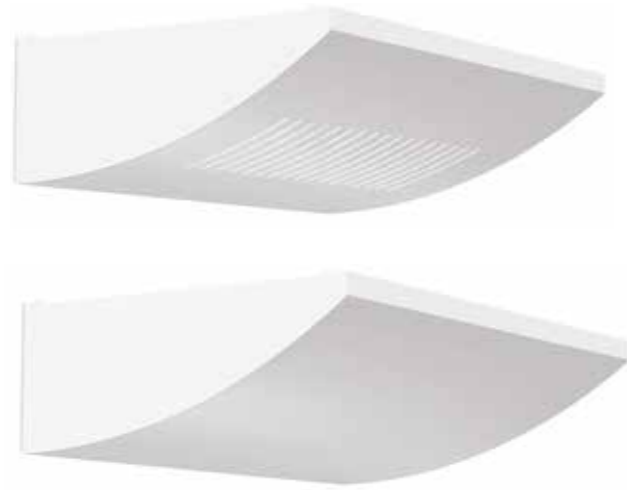

Wall Mounted



| On request - p.XXX |

## IT

Apparecchio decorativo per installazione a parete. Corpo in acciaio al carbonio calandrato e pressopiegato, cod (S) liscio, cod (AM) con feritoie. Sorgente luminosa LED multichip. Verniciatura con polveri epossidiche antigraffio.

## ES

Luminaria decorativa para instalación en pared. Cuerpo de acero al carbono plegado y calandrado, código (S) con difusor liso, código (AM) con difusor raliado. Fuente de iluminación LED multichip. Recubierta con polvo epoxi anti-rayado.

## GB

Decorative lighting fitting for wall installation. Bent and calendered carbon steel body, code (S) smooth, code (AM) with loopholes Multichip LED lighting source. Anti-scratch epoxy powder paint finish.

## DE

Dekoratives Wandbeleuchtungsgerät. Körper aus pressgeformtem und kalandriertem Kohlenstoffstahl, Kode (S) glatt, Kode (AM) mit Gittern. Multichip LED-Leuchtmittel. Lackierung mit kratzfesten Epoxypulvern.

## FR

Appareils décoratif pour l'installation sur le mur. Corps en acier au carbone courbé et calandré, code (S) lisse, code (AM) avec persienne. Source de lumière en LED multichip. Finition de peinture en poudre époxy anti-rayures.

## RU

Xxxx xxxx xxxx

## MALÌ S

Code	Size	Lumen	Watt	K	Beam angle	Driver Type	Driver Nr.	Colour
YMAS38W	01	6300	42	W	D	ON/OFF	1	○
YMAS60W	02	8770	57	W	D	ON/OFF	1	○

## MALÌ AM

Code	Size	Lumen	Watt	K	Beam angle	Driver Type	Driver Nr.	Colour
YAMAM38W	01	6300	42	W	D	ON/OFF	x	○
YAMAM60W	02	8770	57	W	D	ON/OFF	x	○

124  
125

## ○ MALÌ COLOUR SELECTION

- SB | Silver Bombalai
- BL | Bronze Lario
- RR | Rust Rame
- BF | Beige Futuna
- WI | White Irazu
- GK | Gold Karkar
- BT | Blue Telica
- BLL | Black Lava
- CO | Corten
- PC | Primer Coating

## MALÌ S-AM BEAM ANGLE | DIMENSIONS

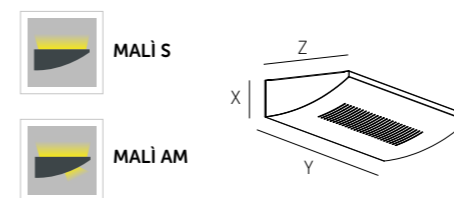

Size	X [mm]	Y [mm]	Z [mm]	Kg
01	92	360	235	
02	92	600	235	



Leila

# Leila

LEILA



Wall Mounted



| On request - p.XXX |

**IT**

Apparecchio decorativo per installazione a parete. Corpo in pressofusione di alluminio. Sorgente luminosa LED COB. Verniciatura con polveri epossidiche antigraffio. Schermo di chiusura in metacrilato trasparente.

**GB**

Decorative lighting fitting for wall installation. Die-cast aluminium body. COB LED lighting source. Anti-scratch epoxy powder paint finish. Transparent methacrylate closing reflector.

**FR**

Appareils décoratif pour l'installation sur le mur. Corps en aluminium moulé sous pression. Source de lumière en LED COB. Finition de peinture en poudre époxy anti-rayures. Écran de fermeture en méthacrylate transparent.

**ES**

Luminaria decorativa para instalación en pared. Cuerpo de aluminio fundido a presión. Fuente de iluminación LED COB. Recubierta con polvo epoxi anti-rayado. Difusor de metacrilato transparente.

**DE**

Dekoratives Wandbeleuchtungsgerät. Körper aus Aluminiumdruckguss. COB LED-Leuchtmittel. Lackierung mit kratzfesten Epoxypulvern. Abdeckschirm aus transparent Methacrylat.

**RU**

Xxxx xxxx xxxx

**LEILA**

Code	Size	Lumen	Watt	K	Beam angle	Driver Type	Driver Nr.	Colour
YLE25W	01	2000	26	W	D	ON/OFF	1	○

○ **LEILA** COLOUR SELECTION

○ **BI** | Bianco      ● **NE** | Nero

**LEILA** BEAM ANGLE | DIMENSIONS

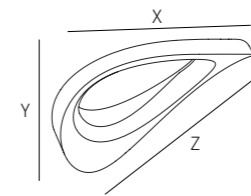

Size	X (mm)	Y (mm)	Z (mm)	Kg
01	252	145	195	1,1



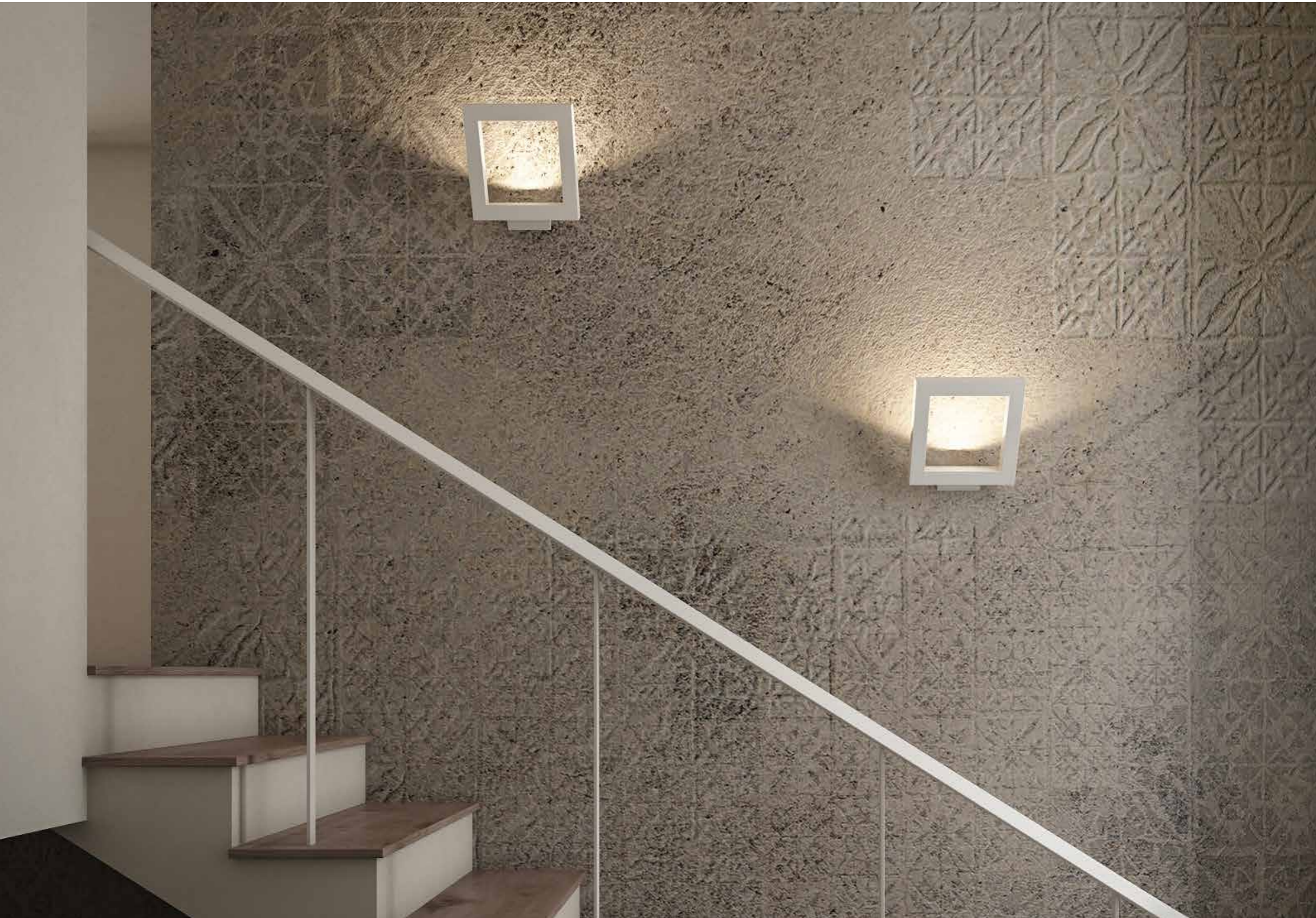



# Norton

NORTON



Wall Mounted



| On request - p.XXX |

**IT**

Apparecchio decorativo per installazione a parete con inclinazione regolabile Corpo in pressofusione di alluminio. Sorgente luminosa LED. Verniciatura con polveri epossidiche antigraffio. Schermo di chiusura in metacrilato trasparente.

**GB**

Decorative lighting fitting for wall installation with adjustable inclination. Die-cast aluminium body. LED lighting source. Anti-scratch epoxy powder paint finish. Transparent methacrylate closing reflector.

**FR**

Appareils décoratif pour l'installation sur le mur avec inclinaison réglable. Corps en aluminium moulé sous pression. Source de lumière en LED. Finition de peinture en poudre époxy anti-rayures. Écran de fermeture en méthacrylate transparent.

**ES**

Luminaria decorativa para instalación en pared con inclinación regulable. Cuerpo de aluminio fundido a presión Fuente de iluminación LED. Recubierta con polvo epoxi anti-rayado. Difusor de metacrilato transparente.

**DE**

Dekoratives Wandbeleuchtungsgerät mit einstellbarer Neigung. Körper aus Aluminiumdruckguss. LED-Leuchtmittel. Lackierung mit kratzfesten Epoxypulvern. Abdeckschirm aus transparent Methacrylat.

**RU**

Xxxx xxxx xxxx

**NORTON**

Code	Size	Lumen	Watt	K	Beam angle	Driver Type	Driver Nr.	Colour
YNO29W	01	1300	14	W	D	ON/OFF	1	○

○ **NORTON** COLOUR SELECTION

- BI | Bianco
- NE | Nero
- RR | Grigio satinato

132  
133

**NORTON** BEAM ANGLE | DIMENSIONS

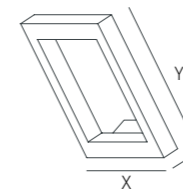

Size	X (mm)	Y (mm)	Z (mm)	Kg
01	290	290	40	2,8



Pia



# Pia

PIA



Wall Mounted



| On request - p.XXX |

**IT**

Apparecchio decorativo per installazione a parete. Corpo in pressofusione di alluminio. Sorgente luminosa LED COB. Verniciatura con polveri epossidiche antigraffio. Schermo di chiusura in metacrilato trasparente.

**GB**

Decorative lighting fitting for wall installation. Die-cast aluminium body. COB LED lighting source. Anti-scratch epoxy powder paint finish. Transparent methacrylate closing reflector.

**FR**

Appareils décoratif pour l'installation sur le mur. Corps en aluminium moulé sous pression. Source de lumière en LED COB. Finition de peinture en poudre époxy anti-rayures. Écran de fermeture en méthacrylate transparent.

**ES**

Luminaria decorativa para instalación en pared. Cuerpo de aluminio fundido a presión. Fuente de iluminación LED COB. Recubierta con polvo epoxi anti-rayado. Difusor de metacrilato transparente.

**DE**

Dekoratives Wandbeleuchtungsgerät. Körper aus Aluminiumdruckguss. COB LED-Leuchtmittel. Lackierung mit kratzfesten Epoxypulvern. Abdeckschirm aus transparent Methacrylat.

**RU**

Xxxx xxxx xxxx

**PIA**

Code	Size	Lumen	Watt	K	Beam angle	Driver Type	Driver Nr.	Colour
YPI20W	01	2000	26	W	D	ON/OFF	1	○

○ **PIA** COLOUR SELECTION

○ **BI** | Bianco      ● **NE** | Nero

**PIA** BEAM ANGLE | DIMENSIONS

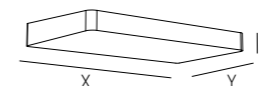

Size	X (mm)	Y (mm)	Z (mm)	Kg
01	204	101	22	1,0



Trem

# Trem

# TREM



Wall Mounted  
Celing Mounted



| On request - p.XXX |

### IT

Apparecchio decorativo per installazione a parete o plafone. Corpo in acciaio al carbonio pressopiegato. Sorgente luminosa LED multichip. Verniciatura con polveri epossidiche antigraffio. Schermo di chiusura in policarbonato opalino.

### ES

Luminaria decorativa para instalación en pared y techo. Cuerpo de acero al carbono plegado. Fuente de iluminación LED multichip. Recubierta con polvo epoxi anti-rayado. Difusor de policarbonato opal.

### GB

Decorative lighting fitting for wall or ceiling installation. Bent carbon steel body. Multichip LED lighting source. Anti-scratch epoxy powder paint finish. Opal polycarbonate closing reflector.

### DE

Dekoratives Wand- und Deckenbeleuchtungsgerät. Körper aus pressgeformtem Kohlenstoffstahl. Multichip LED-Leuchtmittel. Lackierung mit kratzfesten Epoxypulvern. Abdeckschirm aus opalem Polycarbonat.

### FR

Appareils décoratif pour l'installation sur le mur ou plafond. Corps en acier au carbone courbé. Source de lumière en LED multichip. Finition de peinture en poudre époxy anti-rayures. Écran de fermeture en polycarbonate opale.

### RU

Xxxx xxxx xxxx

### TREM

Code	Size	Lumen	Watt	K	Beam angle	Driver Type	Driver Nr.	Colour
YTR58W	01	9680	58	W	D	ON/OFF	2	○

### ○ TREM COLOUR SELECTION

- **SB** | Silver Bombalai
- **BL** | Bronze Lario
- **RR** | Rust Rame
- **BF** | Beige Futuna
- **WI** | White Irazu
- **GK** | Gold Karkar
- **BT** | Blue Telica
- **BLL** | Black Lava
- **CO** | Corten
- **PC** | Primer Coating

140  
141

### TREM BEAM ANGLE | DIMENSIONS

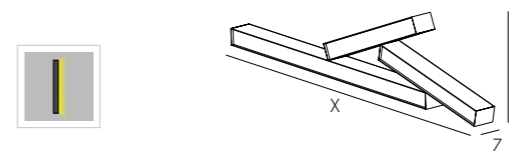

Size	X [mm]	Y [mm]	Z [mm]	Kg
01	1500	500	90	XX





# Bombeii

BOMBEI



Only Wall Mounted



| On request - p.XXX | Magnet

**IT**

Apparecchio decorativo per installazione a parete. Corpo in alluminio tornito intercambiabile con fissaggio magnetico. Sorgente luminosa LED multichip. Verniciatura con polveri epossidiche antigraffio. Schermo di chiusura in policarbonato opale. Finitura frontale con fissaggio magnetico.

**ES**

Luminaria decorativa para instalación en pared. Cuerpo aluminio torneado intercambiabile con fijación magnética. Fuente de iluminación LED multichip. Recubierta con polvo epoxi anti-rayado. Difusor de policarbonato opal. Acabado frontal con fijación magnética.

**GB**

Decorative lighting fitting for wall installation. Turned aluminium body, interchangeable with magnetic fixing. Multichip LED lighting source. Anti-scratch epoxy powder paint finish. Opal polycarbonate closing reflector. Front finish with magnetic fixing.

**DE**

Dekoratives Wandbeleuchtungsgerät. Körper aus pressgeformtem Kohlenstoffstahl austauschbar mit Magnetbefestigung. Multichip LED-Leuchtmittel. Lackierung mit kratzfesten Epoxypulvern. Abdeckschirm aus opalem Polycarbonat.

**FR**

Appareils décoratif pour l'installation sur le mur. Corps en aluminium tourné interchangeable avec fixation magnétique. Source de lumière en LED multichip. Finition de peinture en poudre époxy anti-rayures. Écran de fermeture en polycarbonate opale. Finition avant avec fixation magnétique.

**RU**

Xxxx xxxx xxxx

**BOMBEI**

Code	Size	Lumen	Watt	K	Beam angle	Driver Type	Driver Nr.	Colour
YB01W	01	2500	21	W	D	ON/OFF	1	○

○ **BOMBEI** COLOUR SELECTION

- **SB** | Silver Bombalai
- **BL** | Bronze Lario
- **RR** | Rust Rame
- **BF** | Beige Futuna
- **WI** | White Irazu
- **GK** | Gold Karkar
- **BT** | Blue Telica
- **BLL** | Black Lava
- **CO** | Corten
- **PC** | Primer Coating

144  
145

**BOMBEI** BEAM ANGLE | DIMENSIONS

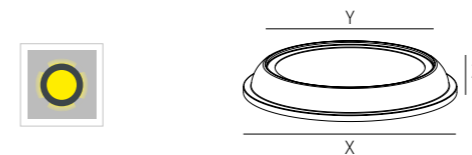

Size	X (mm)	Y (mm)	Z (mm)	Kg
01	ø 385	305	53	XX



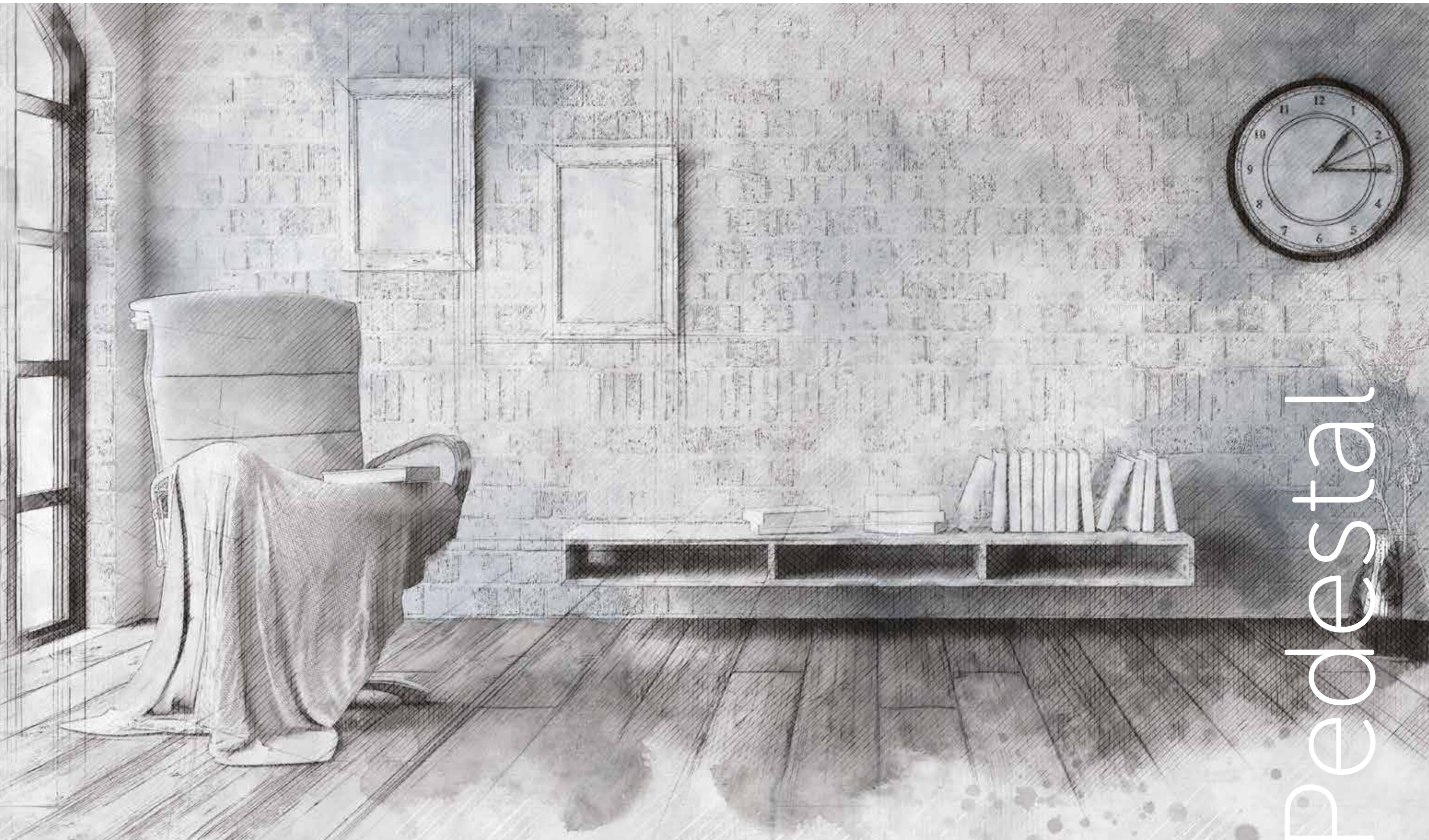

pedestal





# Amadeus

## AMADEUS



Pedestal



**5Y WARRANTY**  
5% FAILURE RATE

**60.000 h**  
LED LIFETIME L90B10

### IT

Lampada da terra decorativa. Corpo in acciaio al carbonio pressopiegato. Sorgente luminosa LED multichip. Verniciatura con polveri epossidiche antigraffio. Schermo di chiusura in policarbonato opale.

### ES

Luminaria de suelo decorativa. Cuerpo de acero al carbono plegado. Fuente de iluminación LED multichip. Recubierta con polvo epoxi anti-rayado. Difusor de policarbonato opal.

### GB

Pedestal for decorative lighting. Bent carbon steel body. Multichip LED lighting source. Anti-scratch epoxy powder paint finish. Opal polycarbonate closing reflector.

### DE

Dekoratives Stehleuchte. Körper aus pressgeformtem Kohlenstoffstahl. Multichip LED-Leuchtmittel. Lackierung mit kratzfesten Epoxypulvern. Abdeckschirm aus opalem Polycarbonat.

### FR

Décoratif lampe au sol. Corps en acier au carbone courbé. Source de lumière en LED multichip. Finition de peinture en poudre époxy anti-rayures. Écran de fermeture en polycarbonate opale.

### RU

Xxxx xxxx xxxx

### AMADEUS

Code	Size	Lumen	Watt	K	Beam angle	Driver Type	Driver Nr.	Colour
YAM90W	01	8900	90	W	D	ON/OFF	1	○

### ○ AMADEUS COLOUR SELECTION

- **SB** | Silver Bombalai
- **BL** | Bronze Lario
- **RR** | Rust Rame
- **BF** | Beige Futuna
- **WI** | White Irazu
- **GK** | Gold Karkar
- **BT** | Blue Telica
- **BLL** | Black Lava
- **CO** | Corten
- **PC** | Primer Coating

150  
151

### AMADEUS BEAM ANGLE | DIMENSIONS

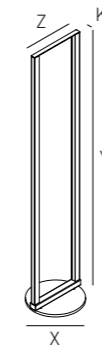

Size	X [mm]	Y [mm]	Z [mm]	K [mm]	Kg
01	∅ 320	1670	340	27	



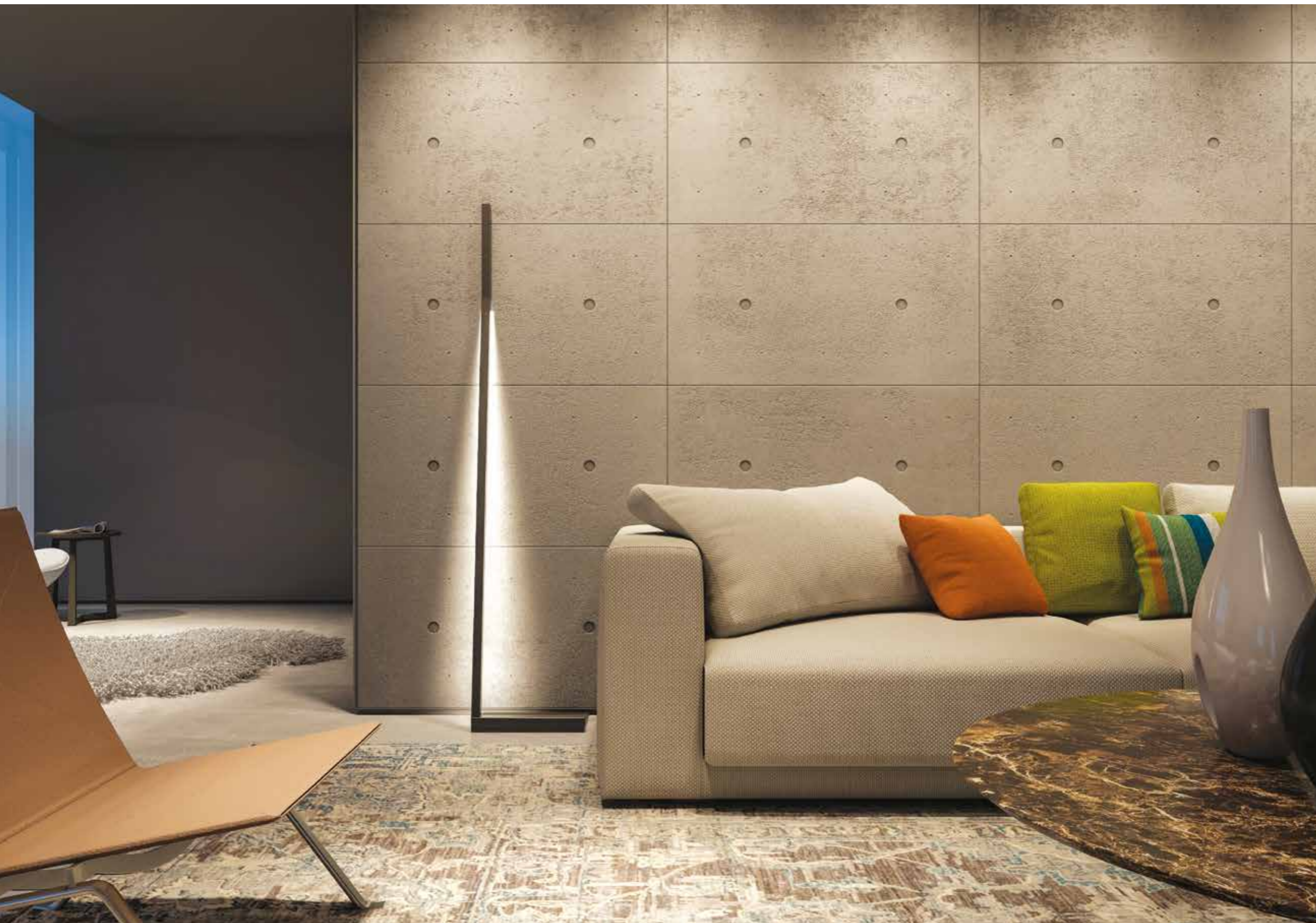

# Silence



# Silence

## SILENCE



Pedestal



### SILENCE

Code	Size	Lumen	Watt	K	Beam angle	Driver Type	Driver Nr.	Colour
YSI37W	01	3640	37	W	D	ON/OFF	1	○

### ○ SILENCE COLOUR SELECTION

- **SB** | Silver Bombalai
- **BL** | Bronze Lario
- **RR** | Rust Rame
- **BF** | Beige Futuna
- **WI** | White Irazu
- **GK** | Gold Karkar
- **BT** | Blue Telica
- **BLL** | Black Lava
- **CO** | Corten
- **PC** | Primer Coating

154  
155



#### IT

Lampada da terra decorativa. Corpo in acciaio al carbonio pressopiegato. Sorgente luminosa LED multichip. Verniciatura con polveri epossidiche antigraffio. Schermo di chiusura in policarbonato opale.

#### GB

Pedestal for decorative lighting. Bent carbon steel body. Multichip LED lighting source. Anti-scratch epoxy powder paint finish. Opal polycarbonate closing reflector.

#### FR

Décoratif lampe au sol. Corps en acier au carbone courbé. Source de lumière en LED multichip. Finition de peinture en poudre époxy anti-rayures. Écran de fermeture en polycarbonate opale.

#### ES

Luminaria de suelo decorativa. Cuerpo de acero al carbono plegado. Fuente de iluminación LED multichip. Recubierta con polvo epoxi anti-rayado. Difusor de policarbonato opal.

#### DE

Dekoratives Stehleuchte. Körper aus pressgeformtem Kohlenstoffstahl. Multichip LED-Leuchtmittel. Lackierung mit kratzfesten Epoxypulvern. Abdeckschirm aus opalem Polycarbonat.

#### RU

Xxxx xxxx xxxx

### SILENCE BEAM ANGLE | DIMENSIONS

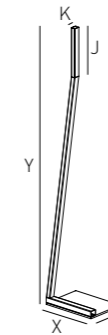

Size	X [mm]	Y [mm]	Z [mm]	K [mm]	J [mm]	Kg
01	340	1632	254	27	300	



Utile

# Utile

# UTILE



Pedestal



## UTILE

Code	Size	Lumen	Watt	K	Beam angle	Driver Type	Driver Nr.	Colour
YUT57W	01	8450	57	W	D	ON/OFF	1	○

## ○ UTILE COLOUR SELECTION

- **SB** | Silver Bombalai
- **BL** | Bronze Lario
- **RR** | Rust Rame
- **BF** | Beige Futuna
- **WI** | White Irazu
- **GK** | Gold Karkar
- **BT** | Blue Telica
- **BLL** | Black Lava
- **CO** | Corten
- **PC** | Primer Coating

158  
159



| On request - p.XXX |

### IT

Lampada da terra decorativa. Corpo in alluminio estruso. Struttura di supporto in acciaio al carbonio. Sorgente luminosa LED multichip. Verniciatura con polveri epossidiche antigraffio. Schermo di chiusura in policarbonato opale.

### GB

Pedestal for decorative lighting. Extruded aluminium body. Support structure in carbon steel. Multichip LED lighting source. Anti-scratch epoxy powder paint finish. Opal polycarbonate closing reflector.

### FR

Décoratif lampe au sol. Corps en aluminium extrudé. Structure de support en acier au carbone. Source de lumière en LED multichip. Finition de peinture en poudre époxy anti-rayures. Écran de fermeture en polycarbonate opale.

### ES

Luminaria de suelo decorativa. Cuerpo en aluminio extruido. Estructura de soporte en acero al carbono. Fuente de iluminación LED multichip. Recubierta con polvo epoxi anti-rayado. Difusor de policarbonato opal.

### DE

Dekoratives Stehleuchte. Körper aus extrudiertem Aluminium. Tragstruktur aus Kohlenstoffstahl. Multichip LED-Leuchtmittel. Lackierung mit kratzfesten Epoxypulvern. Abdeckschirm aus opalem Polycarbonat.

### RU

Xxxx xxxx xxxx

## UTILE BEAM ANGLE | DIMENSIONS

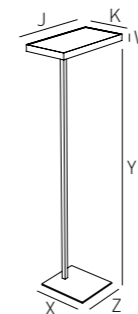

Size	X [mm]	Y [mm]	Z [mm]	J [mm]	K [mm]	W [mm]	Kg
01	400	1910	355	620	260	45	





Zero

# Zero

# ZERO

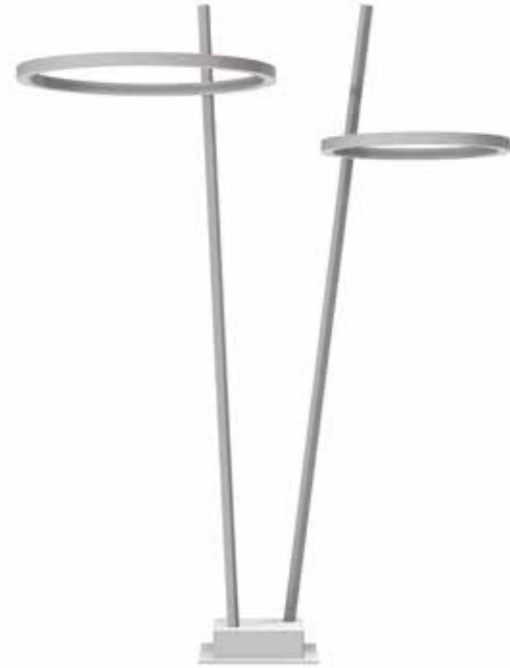

Pedestal

I	LED	CE	⊕	90 CRI	40 IP	230 V	50/60 Hz	07 IK	850°	🔄	A+ IEE
---	-----	----	---	-----------	----------	----------	-------------	----------	------	---	-----------

<b>5Y WARRANTY</b> 5% FAILURE RATE	<b>60.000 h</b> LED LIFETIME L90B10	<b>DL</b> DALI	<b>EM</b> EN 60598-2-22
---------------------------------------	--	-------------------	----------------------------

| On request - p.XXX |

**IT**

Lampada da terra decorativa  
Corpo in acciaio al carbonio calandrato e pressopiegato. Struttura di supporto in acciaio al carbonio. Sorgente luminosa LED multichip. Verniciatura con polveri epossidiche antigraffio. Schermo di chiusura in policarbonato opale.

**ES**

Luminaria de suelo decorativa.  
Cuerpo de acero al carbono plegado y calandrado. Estructura de soporte en acero al carbono. Fuente de iluminación LED multichip. Recubierta con polvo epoxi anti-rayado. Difusor de policarbonato opal.

**GB**

Pedestal for decorative lighting. Bent and calendered carbon steel body. Support structure in carbon steel. Multichip LED lighting source. Anti-scratch epoxy powder paint finish. Opal polycarbonate closing reflector.

**DE**

Dekoratives Stehleuchte. Körper aus kalandriertem und pressgeformtem Kohlenstoffstahl Tragstruktur aus Kohlenstoffstahl. Multichip LED-Leuchtmittel. Lackierung mit kratzfesten Epoxypulvern. Abdeckschirm aus opalem Polycarbonat.

**FR**

Décoratif lampe au sol. Corps en acier au carbone courbé et calandré. Structure de support en acier au carbone. Source de lumière en LED multichip. Finition de peinture en poudre époxy anti-rayures. Écran de fermeture en polycarbonate opale.

**RU**

Xxxx xxxx xxxx

**ZERO**

Code	Size	Lumen	Watt	K	Beam angle	Driver Type	Driver Nr.	Colour
YUT57W	01	8450	57	W	D	ON/OFF	1	○

○ **ZERO** COLOUR SELECTION

- **SB** | Silver Bombalai
- **BL** | Bronze Lario
- **RR** | Rust Rame
- **BF** | Beige Futuna
- **WI** | White Irazu
- **GK** | Gold Karkar
- **BT** | Blue Telica
- **BLL** | Black Lava
- **CO** | Corten
- **PC** | Primer Coating

162  
163

**ZERO** BEAM ANGLE | DIMENSIONS

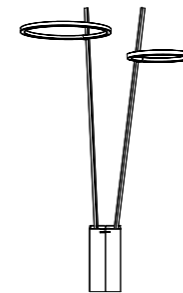

Size	X [mm]	Y [mm]	Z [mm]	J [mm]	K [mm]	W [mm]	Kg
01							



Birboa



# Birba

# BIRBA



Pedestal



| On request - p.XXX |

## IT

Lampada da terra decorativa. Vano alimentatore in alluminio estruso verniciato con polveri epossidiche antigraffio. Sorgente luminosa LED multichip. Corpo diffusore in policarbonato opale

## GB

Pedestal for decorative lighting. Extruded aluminium power supply compartment. Anti-scratch epoxy powder paint finish. Multichip LED lighting source. Opal polycarbonate diffuser body.

## FR

Décoratif lampe au sol. Compartiment d'alimentation en aluminium extrudé. Finition de peinture en poudre époxy anti-rayures. Source de lumière en LED multichip. Corps diffuseur en polycarbonate opale.

## ES

Luminaria de suelo decorativa. Compartimento de fuente de alimentación en aluminio extruido. Fuente de iluminación LED multichip. Recubierta con polvo epoxi anti-rayado. Cuerpo difusor de policarbonato opal.

## DE

Dekoratives Stehleuchte. Netzteilfach aus extrudiertem Aluminium. Lackierung mit kratzfesten Epoxypulvern. Multichip LED-Leuchtmittel. Diffusor Körper aus opalem Polycarbonat.

## RU

Xxxx xxxx xxxx

## BIRBA

Code	Size	Lumen	Watt	K	Beam angle	Driver Type	Driver Nr.	Colour
13W	01	5600	56	W	D	ON/OFF	1	○
18W	02	8400	84	W	D	ON/OFF	1	○
23W	03	11200	112	W	D	ON/OFF	1	○

## ○ BIRBA COLOUR SELECTION

- **SB** | Silver Bombalai
- **BL** | Bronze Lario
- **RR** | Rust Rame
- **BF** | Beige Futuna
- **WI** | White Irazu
- **GK** | Gold Karkar
- **BT** | Blue Telica
- **BLL** | Black Lava
- **CO** | Corten
- **PC** | Primer Coating

## BIRBA BEAM ANGLE | DIMENSIONS

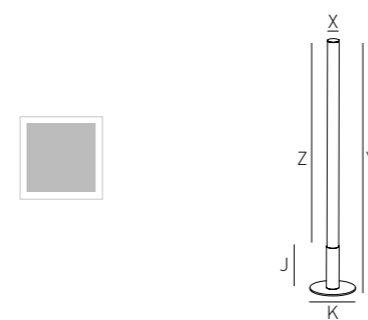

Size	X [mm]	Y [mm]	Z [mm]	J [mm]	K [mm]	Kg
01						
02						
03						



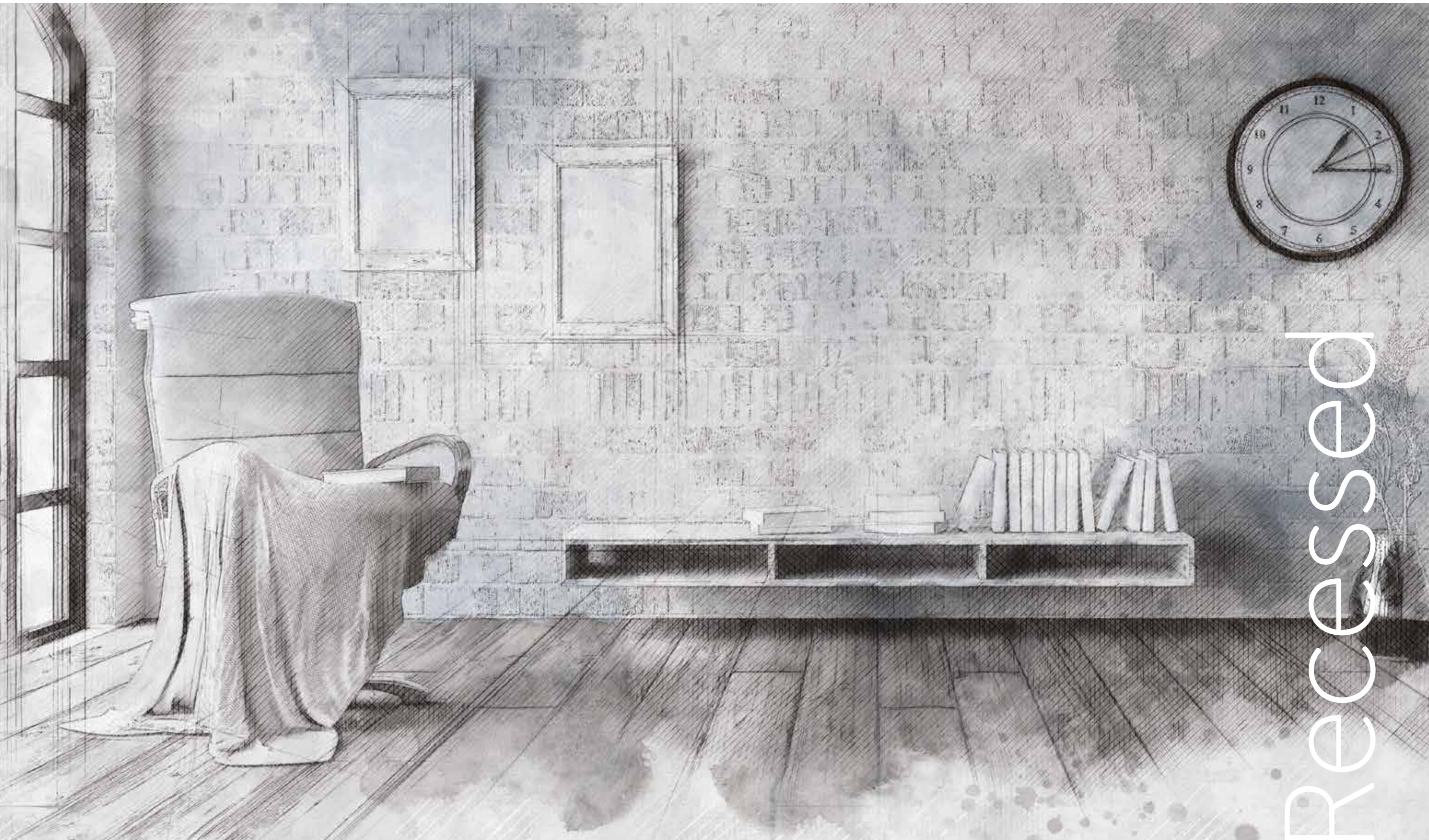

recessed



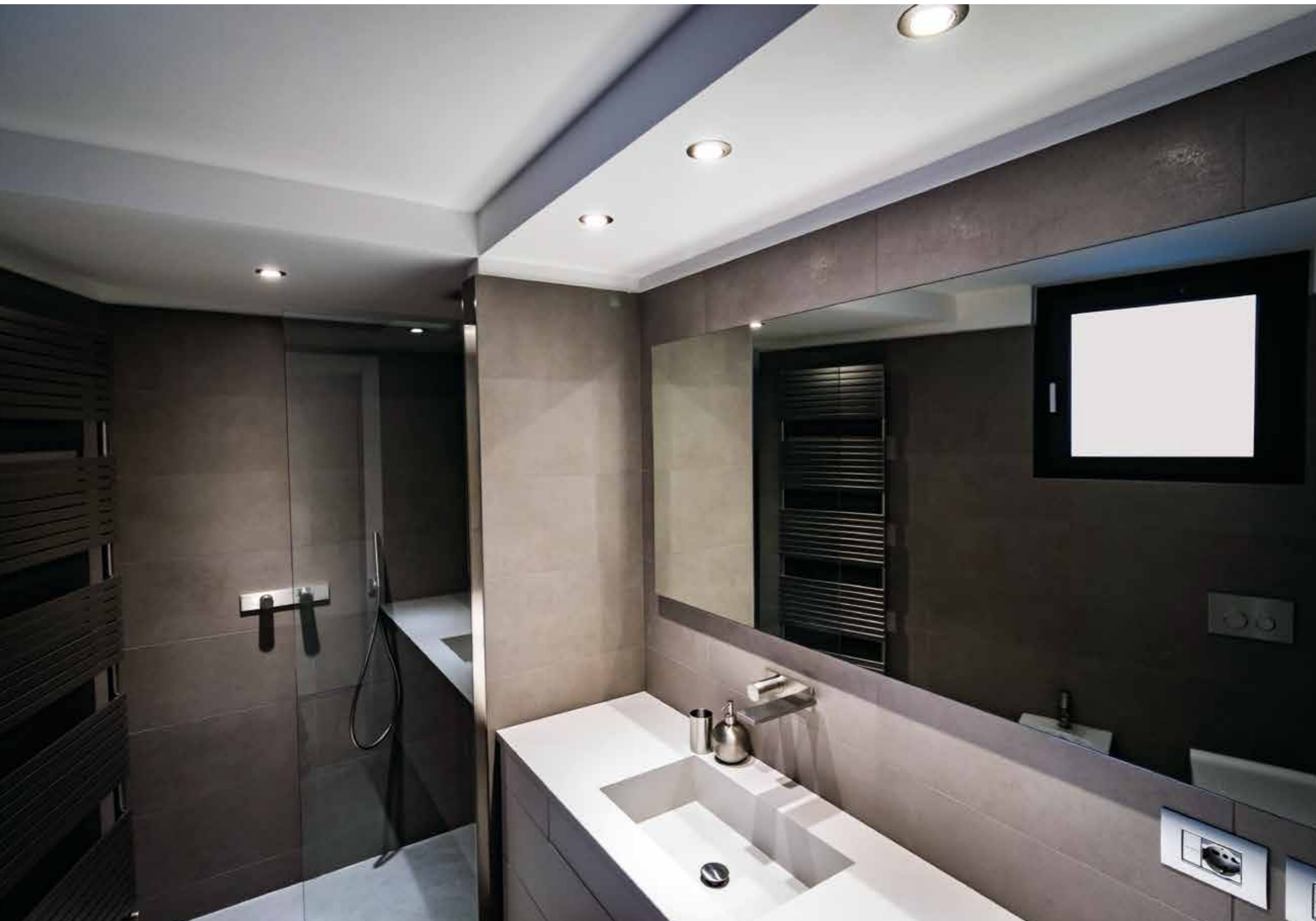

Downlights

170  
171





Tonda



Orient



# TONDO LED ORIENT LED

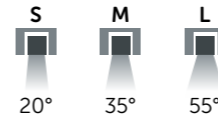

01



02

## TONDO LED VARIO LUMEN

Code	Size	Lumen	Watt	K	Beam angle	Driver Type	Driver Nr.	Colour
YTOVLSW	01	780   1050   1250	6   8   10	W	S	ON/OFF	1	○
YTOVLMW	01	780   1050   1250	6   8   10	W	M	ON/OFF	1	○
YTOVLLW	01	780   1050   1250	6   8   10	W	L	ON/OFF	1	○

## ORIENT LED VARIO LUMEN

Code	Size	Lumen	Watt	K	Beam angle	Driver Type	Driver Nr.	Colour
YTORLSW	02	780   1050   1250	6   8   10	W	S	ON/OFF	1	○
YTORLMW	02	780   1050   1250	6   8   10	W	M	ON/OFF	1	○
YTORLLW	02	780   1050   1250	6   8   10	W	L	ON/OFF	1	○

Recessed

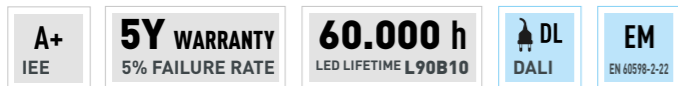

| On request - p.XXX |

### IT

Apparecchio decorativo per installazione ad incasso. Corpo in pressofusione di alluminio. Sorgente luminosa LED COB. Verniciatura con polveri epossidiche antigraffio. Schermo di chiusura in metacrilato trasparente.

### GB

Decorative lighting fitting for recessed installation. Die-cast aluminium body. COB LED lighting source. Anti-scratch epoxy powder paint finish. Transparent methacrylate closing reflector.

### FR

Appareils décoratif pour installation encastrée. Corps en aluminium moulé sous pression. Source de lumière en LED COB. Finition de peinture en poudre époxy anti-rayures. Écran de fermeture en méthacrylate transparent.

### ES

Luminaria decorativa para instalación empotrable. Cuerpo de aluminio fundido a presión. Fuente de iluminación LED COB. Recubierta con polvo epoxi anti-rayado. Difusor de metacrilato transparente.

### DE

Dekoratives Einbaubeleuchtungsgerät. Körper aus Aluminiumdruckguss. COB LED-Leuchtmittel. Lackierung mit kratzfesten Epoxypulvern. Abdeckschirm aus transparent Methacrylat.

### RU

Xxxx xxxx xxxxx

## ○ TONDO LED - ORIENT LED COLOUR SELECTION

- SB | Silver Bombalai
- BL | Bronze Lario
- RR | Rust Rame
- BF | Beige Futuna
- WI | White Irazu
- GK | Gold Karkar
- BT | Blue Telica
- BLL | Black Lava
- PC | Primer Coating

## TONDO LED - ORIENT LED BEAM ANGLE | DIMENSIONS

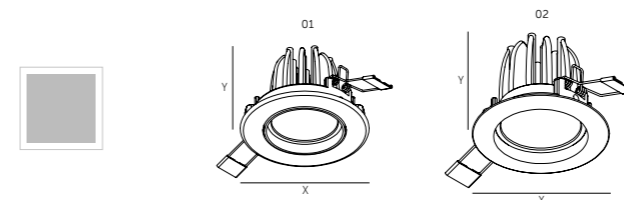

Size	X [mm]	Y [mm]	Ø [mm]	Kg
01	Ø 75	90	65	
02	Ø 85	290	75	

Demi



Orient Q

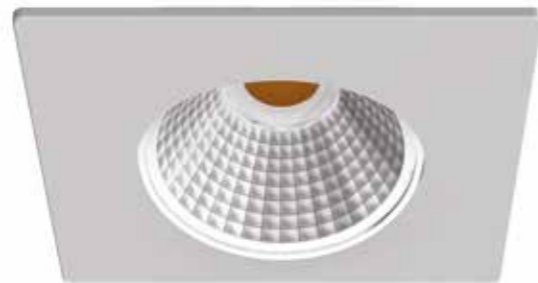

# DEMI LED ORIENT Q LED

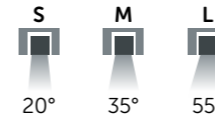

01



02

## DEMI LED VARIO LUMEN

Code	Size	Lumen	Watt	K	Beam angle	Driver Type	Driver Nr.	Colour
YDEVLSW	01	780   1050   1250	6   8   10	W	S	ON/OFF	1	○
YDEVLMW	01	780   1050   1250	6   8   10	W	M	ON/OFF	1	○
YDEVLLW	01	780   1050   1250	6   8   10	W	L	ON/OFF	1	○

## ORIENT Q LED VARIO LUMEN

Code	Size	Lumen	Watt	K	Beam angle	Driver Type	Driver Nr.	Colour
YORQVLSW	02	780   1050   1250	6   8   10	W	S	ON/OFF	1	○
YORQVLMW	02	780   1050   1250	6   8   10	W	M	ON/OFF	1	○
YORQVLLW	02	780   1050   1250	6   8   10	W	L	ON/OFF	1	○

Recessed

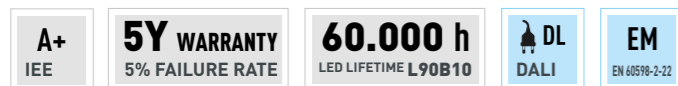

| On request - p.XXX |

### IT

Apparecchio decorativo per installazione ad incasso. Corpo in pressofusione di alluminio (ORIENT Q), in acciaio al carbonio pressopiegato (DEMI). Sorgente luminosa LED COB. Verniciatura con polveri epossidiche antigraffio. Schermo di chiusura in metacrilato trasparente.

### ES

Luminaria decorativa para instalación empotrables. Cuerpo de aluminio fundido a presión (ORIENT Q), cuerpo en acero al carbono plegado a presión (DEMI). Fuente de iluminación LED COB. Recubierta con polvo epoxi anti-rayado. Difusor de metacrilato transparente.

### GB

Decorative lighting fitting for recessed installation. Die-cast aluminium body (ORIENT Q), bent carbon steel body (DEMI). COB LED lighting source. Anti-scratch epoxy powder paint finish. Transparent methacrylate closing reflector.

### DE

Dekoratives Einbaubeleuchtungsgerät. Körper aus Aluminiumdruckguss (ORIENT Q), Körper aus pressgeformtem Kohlenstoffstahl. COB LED-Leuchtmittel. Lackierung mit kratzfesten Epoxypulvern. Abdeckschirm aus transparent Methacrylat.

### FR

Appareils décoratif pour installation encastrée. Corps en aluminium moulé sous pression (ORIENT Q), corps en acier au carbone courbé (DEMI). Source de lumière en LED COB. Finition de peinture en poudre époxy anti-rayures. Écran de fermeture en méthacrylate transparent.

### RU

Xxxx xxxx xxxxx

## ○ DEMI LED - ORIENT Q LED COLOUR SELECTION

- SB | Silver Bombalai
- BL | Bronze Lario
- RR | Rust Rame
- BF | Beige Futuna
- WI | White Irazu
- GK | Gold Karkar
- BT | Blue Telica
- BLL | Black Lava
- PC | Primer Coating

## DEMI LED - ORIENT Q LED BEAM ANGLE | DIMENSIONS

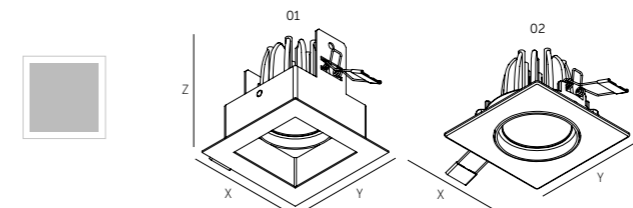

Size	X (mm)	Y (mm)	Z (mm)	∅ (mm)	Kg
01	84	84	max 113	70	
Size	X (mm)	Y (mm)	Z (mm)	∅ (mm)	Kg
02	84	84	max 90	75	

Sei

SEI



01

**SEI** VARIO

Code	Size	Lumen	Watt	K	Beam angle	Driver Type	Driver Nr.	Colour
Y16W	01			W	D	ON/OFF	1	○

○ **SEI** COLOUR SELECTION

○ **BI** | Bianco

Recessed



| On request - p.XXX |

**SEI** BEAM ANGLE | DIMENSIONS

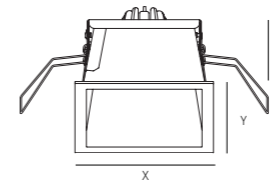

Size	X [mm]	Y [mm]	Z [mm]	Weight [mm]	Kg
01	100	100	80	92x92	

**IT**

Apparecchio decorativo per installazione ad incasso. Corpo in pressofusione di alluminio. Sorgente luminosa LED COB. Verniciatura con polveri epossidiche antigraffio. Schermo di chiusura in metacrilato trasparente.

**GB**

Decorative lighting fitting for recessed installation. Die-cast aluminium body. COB LED lighting source. Anti-scratch epoxy powder paint finish. Transparent methacrylate closing reflector.

**FR**

Appareils décoratif pour installation encastrée. Corps en aluminium moulé sous pression. Source de lumière en LED COB. Finition de peinture en poudre époxy anti-rayures. Écran de fermeture en méthacrylate transparent.

**ES**

Luminaria decorativa para instalación empotrables. Cuerpo de aluminio fundido a presión. Fuente de iluminación LED COB. Recubierta con polvo epoxi anti-rayado. Difusor de metacrilato transparente.

**DE**

Dekoratives Einbaubeleuchtungsgerät. Körper aus Aluminiumdruckguss. COB LED-Leuchtmittel. Lackierung mit kratzfesten Epoxypulvern. Abdeckschirm aus transparent Methacrylat.

**RU**

Xxxx xxxx xxxx

Lookup



Uno



UNO

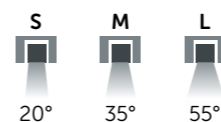

01

**UNO** VARIO *LUMEN*

Code	Size	Lumen	Watt	K	Beam angle	Driver Type	Driver Nr.	Colour
YA30VLSW	01	780   1050   1250	6   8   10	W	S	ON/OFF	1	○
YA30VLMW	01	780   1050   1250	6   8   10	W	M	ON/OFF	1	○
YA30VLLW	01	780   1050   1250	6   8   10	W	L	ON/OFF	1	○

Recessed

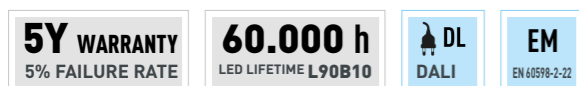

| On request - p.XXX |

**IT**

Apparecchio decorativo per installazione ad incasso. Corpo in alluminio tornito. Sorgente luminosa LED multichip. Verniciatura con polveri epossidiche antigraffio. Schermo di chiusura in policarbonato opale.

**ES**

Luminaria decorativa para instalación empotrables. Cuerpo en aluminio torneado. Fuente de iluminación LED multichip. Recubierta con polvo epoxi anti-rayado. Difusor de policarbonato opal.

**GB**

Decorative lighting fitting for recessed installation. Turned aluminium body. Multichip LED lighting source. Anti-scratch epoxy powder paint finish. Opal polycarbonate closing reflector.

**DE**

Dekoratives Einbauleuchtungsgerät. Körper aus gedrehtem Aluminium. Multichip LED-Leuchtmittel. Lackierung mit kratzfesten Epoxypulvern. Abdeckschirm aus opalem Polycarbonat.

**FR**

Appareils décoratif pour installation encastrée. Corps en aluminium tourné. Source de lumière en LED multichip. Finition de peinture en poudre époxy anti-rayures. Écran de fermeture en polycarbonate opale.

**RU**

Xxxxx xxxx

○ **UNO** COLOUR SELECTION

- **SB** | Silver Bombalai
- **BL** | Bronze Lario
- **RR** | Rust Rame
- **BF** | Beige Futuna
- **WI** | White Irazu
- **GK** | Gold Karkar
- **BT** | Blue Telica
- **BLL** | Black Lava
- **PC** | Primer Coating

**UNO** BEAM ANGLE | DIMENSIONS

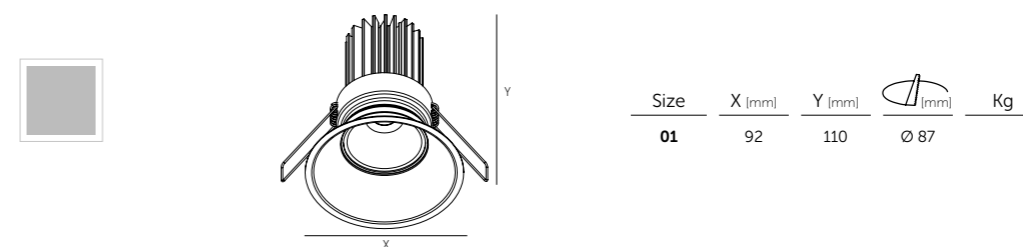

Size	X [mm]	Y [mm]	Ø [mm]	Kg
01	92	110	Ø 87	

Lookup

Rio

RIO

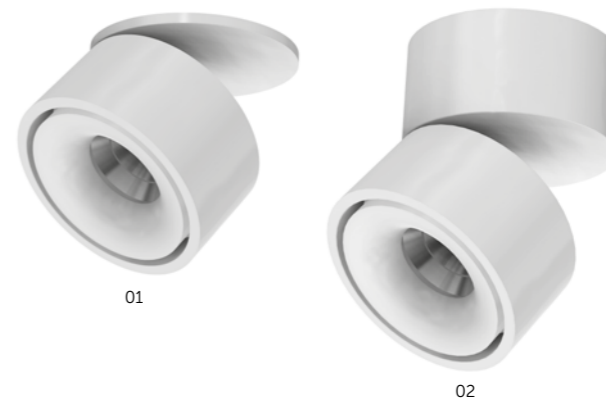

Recessed  
Ceiling Mounted

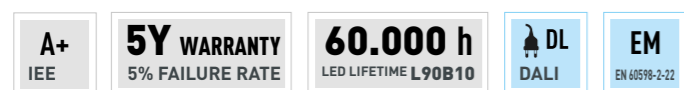

| On request - p.XXX |

**IT**

Apparecchio decorativo per installazione ad incasso (01) o plafone (02). Corpo in pressofusione di alluminio. Sorgente luminosa LED COB. Verniciatura con polveri epossidiche antigraffio. Schermo di chiusura in metacrilato trasparente.

**GB**

Decorative lighting fitting for recessed installation. Die-cast aluminium body. COB LED lighting source. Anti-scratch epoxy powder paint finish. Transparent methacrylate closing reflector.

**FR**

Appareils décoratif pour installation encastrée. Corps en aluminium moulé sous pression. Source de lumière en LED COB. Finition de peinture en poudre époxy anti-rayures. Écran de fermeture en méthacrylate transparent.

**ES**

Luminaria decorativa para instalación empotrables. Cuerpo de aluminio fundido a presión. Fuente de iluminación LED COB. Recubierta con polvo epoxi anti-rayado. Difusor de metacrilato transparente.

**DE**

Dekoratives Einbauleuchtungsgerät. Körper aus Aluminiumdruckguss. COB LED-Leuchtmittel. Lackierung mit kratzfesten Epoxypulvern. Abdeckschirm aus transparent Methacrylat.

**RU**

Xxxx xxxx xxxx

**RIO**

Code	Size	Lumen	Watt	K	Beam angle	Driver Type	Driver Nr.	Colour
YRII13W	01	1180	13	W	D	ON/OFF	1	○
YRIP13W	02	1180	13	W	D	ON/OFF	1	○

○ **RIO** COLOUR SELECTION

○ **BI** | Bianco      ● **NE** | Nero

180  
181

**RIO** BEAM ANGLE | DIMENSIONS



Size	X (mm)	Y (mm)	Z (mm)	Ø (mm)	Kg
<b>01</b>	100	56	50	Ø 89	1,25

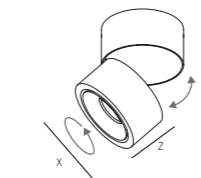

Size	X (mm)	Y (mm)	Z (mm)	Kg
<b>02</b>	Ø 100	100	50	1,25

# Remisi Colour



## REMISI COLOUR



### REMISI COLOUR

Code	Size	Lumen	Watt	K	Beam angle	Driver Type	Driver Nr.	Colour
	01	1270	8	W	D	ON/OFF	1	○
	01	1740	11	W	D	ON/OFF	1	○
	01	2340	15,5	W	D	ON/OFF	1	○
	01	2930	18,5	W	D	ON/OFF	1	○
	01	3220	22	W	D	ON/OFF	1	○

Recessed



| On request - p.XXX |

#### IT

Apparecchio decorativo per installazione ad incasso. Corpo in alluminio tornito. Sorgente luminosa LED multichip. Verniciatura con polveri epossidiche antigraffio. Schermo di chiusura in policarbonato opale.

#### ES

Luminaria decorativa para instalación empotrables. Cuerpo en aluminio torneado. Fuente de iluminación LED multichip. Recubierta con polvo epoxi anti-rayado. Difusor de policarbonato opal.

#### GB

Decorative lighting fitting for recessed installation. Turned aluminium body. Multichip LED lighting source. Anti-scratch epoxy powder paint finish. Opal polycarbonate closing reflector.

#### DE

Dekoratives Einbauleuchtungsgerät. Körper aus gedrehtem Aluminium. Multichip LED-Leuchtmittel. Lackierung mit kratzfesten Epoxypulvern. Abdeckschirm aus opalem Polycarbonat.

#### FR

Appareils décoratif pour installation encastrée. Corps en aluminium tourné. Source de lumière en LED multichip. Finition de peinture en poudre époxy anti-rayures. Écran de fermeture en polycarbonate opale.

#### RU

Xxxxx xxxx

### ○ REMISI COLOUR COLOUR SELECTION

- **SB** | Silver Bombalai
- **BL** | Bronze Lario
- **RR** | Rust Rame
- **BF** | Beige Futuna
- **WI** | White Irazu
- **GK** | Gold Karkar
- **BT** | Blue Telica
- **BLL** | Black Lava
- ▨ **PC** | Primer Coating

### REMISI COLOUR BEAM ANGLE | DIMENSIONS

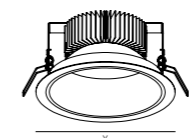

Size	X [mm]	Y [mm]	Z [mm]	Ø [mm]	Kg
<b>01</b>	Ø 200	56	50	Ø 180	1,25



# Hollow



## HOLLOW

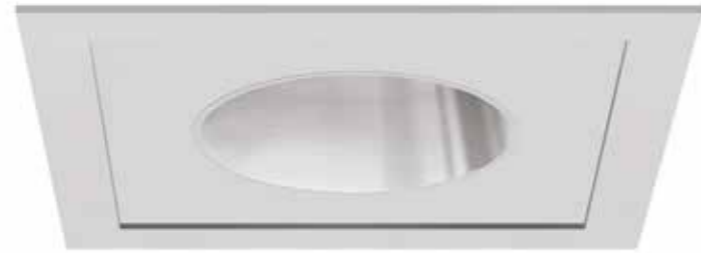

Recessed



| On request - p.XXX |

### IT

Apparecchio decorativo per installazione ad incasso. Corpo in pressofusione di alluminio. Sorgente luminosa LED COB. Verniciatura con polveri epossidiche antigraffio. Schermo di chiusura in metacrilato trasparente.

### GB

Decorative lighting fitting for recessed installation. Die-cast aluminium body. COB LED lighting source. Anti-scratch epoxy powder paint finish. Transparent methacrylate closing reflector.

### FR

Appareils décoratif pour installation encastrée. Corps en aluminium moulé sous pression. Source de lumière en LED COB. Finition de peinture en poudre époxy anti-rayures. Écran de fermeture en méthacrylate transparent.

### ES

Luminaria decorativa para instalación empotrables. Cuerpo de aluminio fundido a presión. Fuente de iluminación LED COB. Recubierta con polvo epoxi anti-rayado. Difusor de metacrilato transparente.

### DE

Dekoratives Einbauleuchtungsgerät. Körper aus Aluminiumdruckguss. COB LED-Leuchtmittel. Lackierung mit kratzfesten Epoxypulvern. Abdeckschirm aus transparent Methacrylat.

### RU

Xxxx xxxx xxxx

### HOLLOW VARIO LUMEN | VARIO KELVIN

Code	Size	Vario Lumen	Watt	K	Beam angle	Driver Type	Driver Nr.	Colour
YHO01VKLW	01	1920   2880   3840	14   21   27	Vario	D	ON/OFF	1	○
YHO02VKLW	02	3840   5760   6880	28   42   54	Vario	D	ON/OFF	1	○
YHO03VKLW	03	5760   8640   10320	42   63   81	Vario	D	ON/OFF	1	○

### HOLLOW

Code	Size	Lumen	Watt	K	Beam angle	Driver Type	Driver Nr.	Colour
YHO01	01	3840	27	W	D	ON/OFF	1	○
YHO01	01	5590	41	W	D	ON/OFF	1	○
YHO01	01	6350	47	W	D	ON/OFF	1	○
YHO01	02	6880	54	W	D	ON/OFF	1	○
YHO01	02	11180	82	W	D	ON/OFF	1	○
YHO01	02	12700	94	W	D	ON/OFF	1	○
YHO01	03	11520	81	W	D	ON/OFF	1	○
YHO01	03	16760	123	W	D	ON/OFF	1	○
YHO01	03	19050	141	W	D	ON/OFF	1	○

### ○ HOLLOW COLOUR SELECTION

- SB | Silver Bombalai
- BL | Bronze Lario
- RR | Rust Rame
- BF | Beige Futuna
- WI | White Irazu
- GK | Gold Karkar
- BT | Blue Telica
- BLL | Black Lava
- ▨ PC | Primer Coating

### HOLLOW BEAM ANGLE | DIMENSIONS

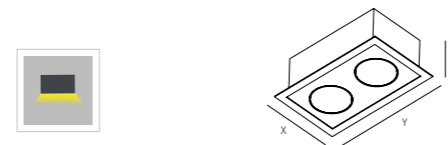

Size	X [mm]	Y [mm]	Z [mm]	Weight [mm]	Kg
01	200	200	181	182x182	
02	200	333	181	182x320	
03	200	467	181	182x455	





# Quare Lamp Tabole Lamp



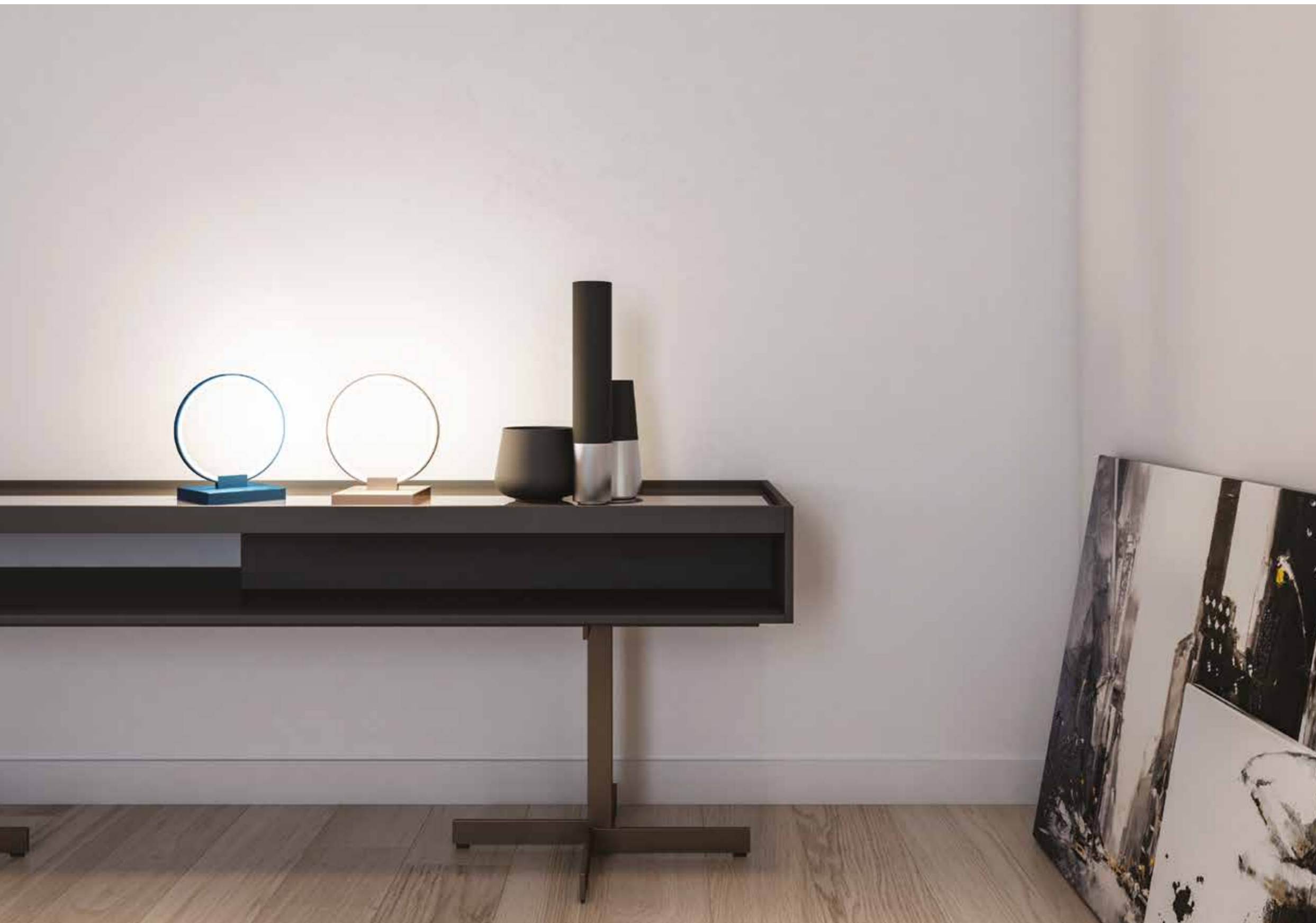

Lina



# Lina

# LINA



Table Lamp



| On request - p.XXX |

## IT

Lampada da tavolo decorativa  
Base d'appoggio in acciaio al carbonio pressopiegato. Corpo lampada in acciaio al carbonio calandarato. Sorgente luminosa LED multichip. Verniciatura con polveri epossidiche antigraffio. Schermo di chiusura in silicone opale.

## ES

Luminaria de mesa decorativa  
Base de apoyo en acero al carbono plegado a presión. Cuerpo en acero al carbono calandrado. Fuente de iluminación LED multichip. Recubierta con polvo epoxi anti-rayado. Difusor de silicona opal.

## GB

Decorative table lamp. Bent carbon steel base support. Calendered carbon steel body. Multichip LED lighting source. Anti-scratch epoxy powder paint finish. Opal silicon closing reflector.

## DE

Dekorative Tischlampe. Stützbasis aus pressgeformtem Kohlenstoffstahl. Lampenkörper aus kalandriertem Kohlenstoffstahl. Multichip LED-Leuchtmittel. Lackierung mit kratzfesten Epoxypulvern. Abdeckschirm aus opal Silikon.

## FR

Lampe de table decorative Base de support en acier au carbone courbé. Corps de lampe en acier au carbone calandré Source de lumière en LED multichip. Finition de peinture en poudre époxy anti-rayures. Écran de fermeture en silicone opale.

## RU

Декоративная настольная лампа. Основание из прессованной углеродистой стали. Корпус лампы из каландрированной углеродистой стали. Источник света мультикристальный СИД. Покрытие устойчивым к царапинам эпоксидным порошком. Закрывающий экран выполнен из матового силикона.

## LINA

Code	Size	Lumen	Watt	K	Beam angle	Driver Type	Driver Nr.	Colour
YANT7W	01	750	7,5	W	D	ON/OFF	1	○

## ○ LINA COLOUR SELECTION

- **SB** | Silver Bombalai
- **BL** | Bronze Lario
- **RR** | Rust Rame
- **BF** | Beige Futuna
- **WI** | White Irazu
- **GK** | Gold Karkar
- **BT** | Blue Telica
- **BLL** | Black Lava
- **PC** | Primer Coating

190  
191

## LINA BEAM ANGLE | DIMENSIONS

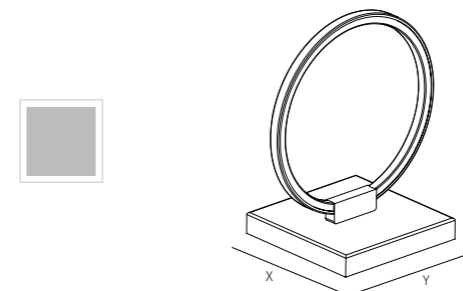

Size	X [mm]	Y [mm]	Z [mm]	Kg
01	130	130	Ø 165	



squadra

192  
193

# Squadra

# SQUADRA

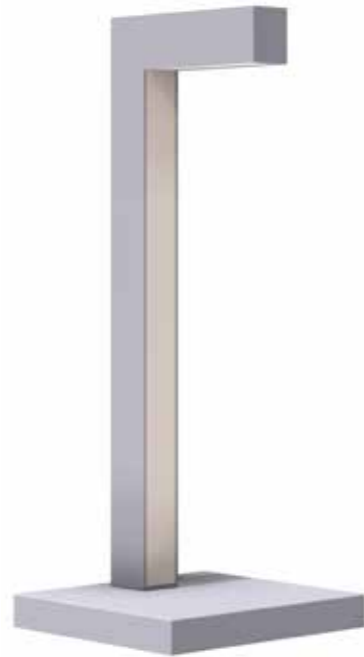

Table Lamp



| On request - p.XXX |

**IT**  
Lampada da tavolo decorativa  
Base d'appoggio e corpo lampada in acciaio al carbonio pressopiegato. Sorgente luminosa LED multichip. Verniciatura con polveri epossidiche antigraffio. Schermo di chiusura in policarbonato opale.

**GB**  
Decorative table lamp. Bent carbon steel base support and body. Multichip LED lighting source. Anti-scratch epoxy powder paint finish. Opal polycarbonate closing reflector.

**FR**  
Lampe de table decorative Base de support et corps en acier au carbone courbé. Source de lumière en LED multichip. Finition de peinture en poudre époxy anti-rayures. Écran de fermeture en polycarbonate opale.

**ES**  
Luminaria de mesa decorativa  
Base de apoyo y cuerpo en acero al carbono plegado a presión. Fuente de iluminación LED multichip. Recubierta con polvo epoxi anti-rayado. Difusor de policarbonato opal.

**DE**  
Dekorative Tischlampe.  
Stützbasis und Lampenkörper aus pressgeformtem Kohlenstoffstahl. Multichip LED-Leuchtmittel. Lackierung mit kratzfesten Epoxypulvern. Abdeckschirm aus opal Polycarbonat.

**RU**  
Декоративная настольная лампа  
Основание и корпус лампы из прессованной углеродистой стали. Источник света мульткристальный СИД. Покрытие устойчивым к царапинам эпоксидным порошком. Закрывающий экран выполнен из матового поликарбоната.

## SQUADRA

Code	Size	Lumen	Watt	K	Beam angle	Driver Type	Driver Nr.	Colour
YSQ7W	01	750	7,5	W	D	ON/OFF	1	○

## ○ SQUADRA COLOUR SELECTION

- **SB** | Silver Bombalai
- **BL** | Bronze Lario
- **RR** | Rust Rame
- **BF** | Beige Futuna
- **WI** | White Irazu
- **GK** | Gold Karkar
- **BT** | Blue Telica
- **BLL** | Black Lava
- **PC** | Primer Coating

194  
195

## SQUADRA BEAM ANGLE | DIMENSIONS

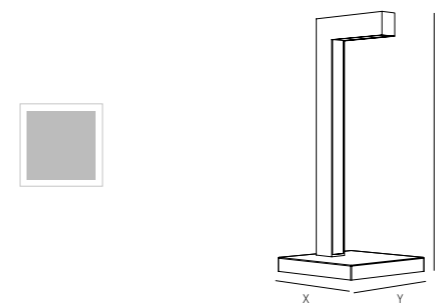

Size	X [mm]	Y [mm]	Z [mm]	Kg
01	150	150	430	





# Sphnere

# Sphere

## SPHERE

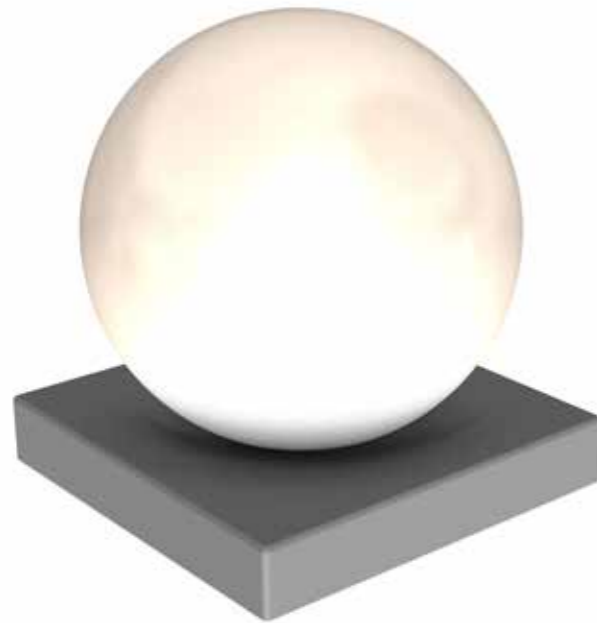

Table Lamp



| On request - p.XXX |

### IT

Lampada da tavolo decorativa. Base d'appoggio in acciaio al carbonio pressopiegato. Corpo diffusore in policarbonato opale. Sorgente luminosa LED multichip. Verniciatura con polveri epossidiche antigraffio.

### ES

Luminaria de mesa decorativa. Base de apoyo y cuerpo en acero al carbono plegado a presión. Cuerpo difusor de policarbonato opal. Fuente de iluminación LED multichip. Recubierta con polvo epoxi anti-rayado.

### GB

Decorative table lamp. Bent carbon steel base support. Opal polycarbonate body diffuser. Multichip LED lighting source. Anti-scratch epoxy powder paint finish.

### DE

Dekorative Tischlampe. Stützbasis und Lampenkörper aus pressgeformtem Kohlenstoffstahl. Diffusor Körper aus opalem Polycarbonat. Multichip LED-Leuchtmittel. Lackierung mit kratzfesten Epoxypulvern.

### FR

Lampe de table decorative. Base de support en acier au carbone courbé. Corps diffuseur en polycarbonate opale. Source de lumière en LED multichip. Finition de peinture en poudre époxy anti-rayures.

### RU

Декоративная настольная лампа. Основание из прессованной углеродистой стали. Корпус-диффузор из матового поликарбоната. Источник света мульткристальный СИД. Покрытие устойчивым к царапинам оксидным порошком.

### SPHERE

Code	Size	Lumen	Watt	K	Beam angle	Driver Type	Driver Nr.	Colour
YSP10W	01	1000	10	W	D	ON/OFF	1	○

### ○ SPHERE COLOUR SELECTION

- **SB** | Silver Bombalai
- **BL** | Bronze Lario
- **RR** | Rust Rame
- **BF** | Beige Futuna
- **WI** | White Irazu
- **GK** | Gold Karkar
- **BT** | Blue Telica
- **BLL** | Black Lava
- **PC** | Primer Coating

198  
199

### SPHERE BEAM ANGLE | DIMENSIONS

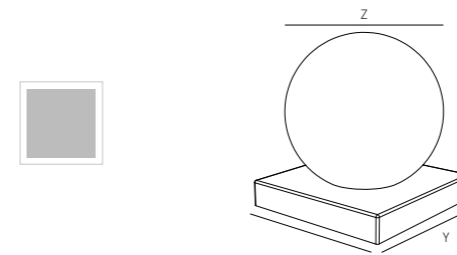

Size	X [mm]	Y [mm]	Z [mm]	Kg
01	150	150	Ø 150	





Stilo  
Ojits



# Stilo

STILO



Table Lamp



| On request - p.XXX |

**IT**

Lampada da tavolo decorativa. Base d'appoggio e corpo lampada in acciaio al carbonio pressopiegato. Sorgente luminosa LED multichip. Verniciatura con polveri epossidiche antigraffio. Schermo di chiusura in policarbonato opale.

**ES**

Luminaria de mesa decorativa. Base de apoyo y cuerpo en acero al carbono plegado a presión. Fuente de iluminación LED multichip. Recubierta con polvo epoxi anti-rayado. Difusor de policarbonato opal.

**GB**

Decorative table lamp. Bent carbon steel base support and body. Multichip LED lighting source. Anti-scratch epoxy powder paint finish. Opal polycarbonate closing reflector.

**DE**

Dekorative Tischlampe. Stützbasis und Lampenkörper aus pressgeformtem Kohlenstoffstahl. Multichip LED-Leuchtmittel. Lackierung mit kratzfesten Epoxypulvern. Abdeckschirm aus opal Polycarbonat.

**FR**

Lampe de table decorative. Base de support et corps en acier au carbone courbé. Source de lumière en LED multichip. Finition de peinture en poudre époxy anti-rayures. Écran de fermeture en polycarbonate opale.

**RU**

Декоративная настольная лампа. Основание и корпус лампы из прессованной углеродистой стали. Источник света мульткристальный СИД. Покрытие устойчивым к царапинам эпоксидным порошком. Закрывающий экран выполнен из матового поликарбоната.

**STILO**

Code	Size	Lumen	Watt	K	Beam angle	Driver Type	Driver Nr.	Colour
YST4W	01	400	4	W	D	ON/OFF	1	○

○ **STILO** COLOUR SELECTION

- **SB** | Silver Bombalai
- **BL** | Bronze Lario
- **RR** | Rust Rame
- **BF** | Beige Futuna
- **WI** | White Irazu
- **GK** | Gold Karkar
- **BT** | Blue Telica
- **BLL** | Black Lava
- **PC** | Primer Coating

**STILO** BEAM ANGLE | DIMENSIONS

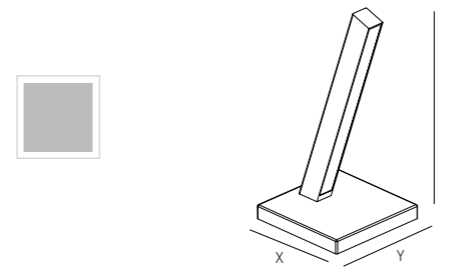

Size	X [mm]	Y [mm]	Z [mm]	Kg
01	150	150	320	





tracklights  
studi







# Beba V



## BEBA V



### Track Lights



| On request - p.XXX |

#### IT

Lampada da tavolo decorativa  
Base d'appoggio in acciaio al carbonio pressopiegato. Corpo lampada in acciaio al carbonio calandarato. Sorgente luminosa LED multichip. Verniciatura con polveri epossidiche antigraffio. Schermo di chiusura in silicone opale.

#### ES

Luminaria de mesa decorativa  
Base de apoyo en acero al carbono plegado a presión. Cuerpo en acero al carbono calandrado. Fuente de iluminación LED multichip. Recubierta con polvo epoxi anti-rayado. Difusor de silicona opal.

#### GB

Decorative table lamp. Bent carbon steel base support. Calendered carbon steel body. Multichip LED lighting source. Anti-scratch epoxy powder paint finish. Opal silicon closing reflector.

#### DE

Dekorative Tischlampe. Stützbasis aus pressgeformtem Kohlenstoffstahl. Lampenkörper aus kalandriertem Kohlenstoffstahl. Multichip LED-Leuchtmittel. Lackierung mit kratzfesten Epoxypulvern. Abdeckschirm aus opal Silikon.

#### FR

Lampe de table decorative Base de support en acier au carbone courbé. Corps de lampe en acier au carbone calandré Source de lumière en LED multichip. Finition de peinture en poudre époxy anti-rayures. Écran de fermeture en silicone opale.

#### RU

Декоративная настольная лампа. Основание из прессованной углеродистой стали. Корпус лампы из каландрированной углеродистой стали. Источник света мульткристальный СИД. Покрытие устойчивым к царапинам эпоксидным порошком. Закрывающий экран выполнен из матового силикона.

### BEBA V VARIO LUMEN | VARIO KELVIN

Code	Size	Vario Lumen	Watt	K	Beam angle	Driver Type	Driver Nr.	Colour
YBE01VKLW	01	1920   2880   3840	14   21   27	Vario	D	ON/OFF	1	○

### BEBA V

Code	Size	Lumen	Watt	K	Beam angle	Driver Type	Driver Nr.	Colour
YBE22W	01	3220	22	W	D	ON/OFF	1	○
YBE27W	01	3840	27	W	D	ON/OFF	1	○
YBE31W	01	5115	31	W	D	ON/OFF	1	○

### ○ BEBA V COLOUR SELECTION

- SB | Silver Bombalai
- BL | Bronze Lario
- RR | Rust Rame
- BF | Beige Futuna
- WI | White Irazu
- GK | Gold Karkar
- BT | Blue Telica
- BLL | Black Lava
- PC | Primer Coating

### BEBA V BEAM ANGLE | DIMENSIONS

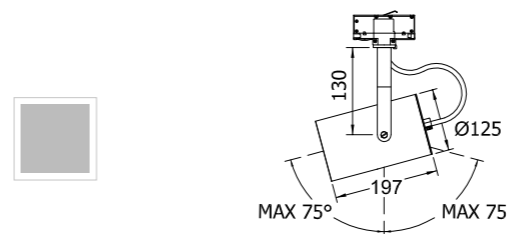

Size	X (mm)	Y (mm)	Z (mm)	Kg
01				

# Lerica V

# LERICA V



## Track Lights



| On request - p.XXX |

### IT

Lampada da tavolo decorativa  
Base d'appoggio in acciaio al carbonio pressopiegato. Corpo lampada in acciaio al carbonio calandariato. Sorgente luminosa LED multichip. Verniciatura con polveri epossidiche antigraffio. Schermo di chiusura in silicone opale.

### ES

Luminaria de mesa decorativa  
Base de apoyo en acero al carbono plegado a presión. Cuerpo en acero al carbono calandrado. Fuente de iluminación LED multichip. Recubierta con polvo epoxi anti-rayado. Difusor de silicona opal.

### GB

Decorative table lamp. Bent carbon steel base support. Calendered carbon steel body. Multichip LED lighting source. Anti-scratch epoxy powder paint finish. Opal silicon closing reflector.

### DE

Dekorative Tischlampe. Stützbasis aus pressgeformtem Kohlenstoffstahl. Lampenkörper aus kalandriertem Kohlenstoffstahl. Multichip LED-Leuchtmittel. Lackierung mit kratzfesten Epoxypulvern. Abdeckschirm aus opal Silikon.

### FR

Lampe de table decorative Base de support en acier au carbone courbé. Corps de lampe en acier au carbone calandré Source de lumière en LED multichip. Finition de peinture en poudre époxy anti-rayures. Écran de fermeture en silicone opale.

### RU

Декоративная настольная лампа. Основание из прессованной углеродистой стали. Корпус лампы из каландрированной углеродистой стали. Источник света мультикристальный СИД. Покрытие устойчивым к царапинам эпоксидным порошком. Закрывающий экран выполнен из матового силикона.

## LERICA V VARIO LUMEN | VARIO KELVIN

Code	Size	Vario Lumen	Watt	K	Beam angle	Driver Type	Driver Nr.	Colour
YLE01VKLW	01	1920   2880   3840	14   21   27	Vario	D	ON/OFF	1	○

## LERICA V

Code	Size	Lumen	Watt	K	Beam angle	Driver Type	Driver Nr.	Colour
YLE22W	01	3220	22	W	D	ON/OFF	1	○
YLE27W	01	3840	27	W	D	ON/OFF	1	○
YLE31W	01	5115	31	W	D	ON/OFF	1	○

## ○ LERICA V COLOUR SELECTION

- SB | Silver Bombalai
- BL | Bronze Lario
- RR | Rust Rame
- BF | Beige Futuna
- WI | White Irazu
- GK | Gold Karkar
- BT | Blue Telica
- BLL | Black Lava
- PC | Primer Coating

## LERICA V BEAM ANGLE | DIMENSIONS

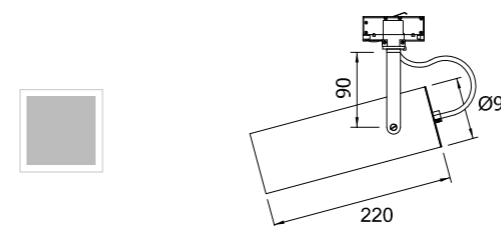

Size	X (mm)	Y (mm)	Z (mm)	Kg
01				







Graphics&Creativity  
Purplecloud design | William Cardani



Contents  
Ufficio tecnico | Ideallux®

LithoPrinter  
Xxxx xxxx

Le informazioni e le caratteristiche tecniche possono essere soggette a variazioni senza preavviso. Ideallux® si riserva in qualsiasi momento, a suo giudizio e senza preavviso, di apportare modifiche ai prodotti inseriti nel proprio catalogo. I dati tecnici contenuti nel catalogo sono da considerarsi validi salvo errori e/o omissioni. La riproduzione del materiale contenuto nel presente catalogo è vietata senza il consenso scritto da parte di Ideallux®.

The information and specifications are subject to changes without notice. Ideallux® reserves the right at any time at its discretion and without notice, to make changes to the products included in its catalogue. The technical data in the catalogue are valid except for errors and/or omissions. The reproduction of the material contained in this catalogue is prohibited without the written consent of Ideallux®.

*Lookup*

