

**IDEALLUX®**

GRUPPO  **RAINA**



**IDEALLUX®**

GRUPP.  **RAINA**

# GRUPPO RAINA

L'unione fa la luce.

**IDEALLUX®**

*Lookup*

**COLOMBO**



# INDICE | INDEX

## INDICE GENERALE | GENERAL INDEX

IV-XI	Indice illustrato • <i>Illustrated index</i>
XIII	Chi siamo • <i>Who we are</i>
XIV	Mission
XV	Ricerca e sviluppo - misure e prove • <i>Research &amp; development - measures &amp; test</i>
XVI	Assistenza clienti • <i>Customer service</i>
XVII	LED info
XVIII	LED: qualità di luce • <i>LED: light quality</i>
XIX-XXIII	Case history
XXIV-XXV	Chiave di lettura • <i>Method of reading the catalogue</i>
XXVI	Legenda • <i>Key to symbols</i>
XXVII	Simboli ed abbreviazioni • <i>Symbols and abbreviations</i>
001	Sospensione - Plafone - Incasso trimless - File continue • <i>Suspension - Ceiling - Recessed trimless - Continuous line</i>
035	Sospensione - Plafone - Parete • <i>Suspension - Ceiling - Wall</i>
055	Decorativi a sospensione - Plafone • <i>Decorative Suspension - Ceiling</i>
067	Reglette LED "prolungabili" • <i>LED light batten "extendable"</i>
079	Incasso • <i>Recessed</i>
115	Incasso downlight • <i>Recessed downlight</i>
141	Incasso orientabili • <i>Adjustable recessed</i>
163	Proiettori a binario • <i>Track lights</i>
177	Sistemi continui • <i>Continuous line systems</i>
201	Industriali e commerciali • <i>Industrial &amp; commercial</i>
227	Plafoniere stagne ad alta protezione meccanica • <i>High protection mechanical waterproof fixture</i>
335	Presentazione catalogo: Lookup® - Colombo • <i>Catalogue presentation: Lookup® - Colombo</i>
340	Resistenza agenti chimici (art. 520) • <i>Chemical agents resistance (art. 520)</i>
341-345	Tabella riassuntiva valori di illuminamento • <i>Light values list</i>
346-350	Indice analitico prodotti • <i>Analytical products index</i>
351-352	Indice analitico accessori • <i>Analytical accessories index</i>
353	Condizioni generali di vendita • <i>Analytical accessories index</i>

## INDICE DI SEZIONE | SECTION INDEX

001	<b>A</b>	Sospensione - Plafone - Incasso trimless - File continue • <i>Suspension - Ceiling - Recessed trimless - Continuous line</i>
035	<b>B</b>	Sospensione - Plafone - Parete • <i>Suspension - Ceiling - Wall</i>
055	<b>C</b>	Decorativi a sospensione - Plafone • <i>Decorative Suspension - Ceiling</i>
067	<b>D</b>	Reglette LED "prolungabili" • <i>LED light batten "extendable"</i>
079	<b>E</b>	Incasso • <i>Recessed</i>
115	<b>F</b>	Incasso downlight • <i>Recessed downlight</i>
141	<b>G</b>	Incasso orientabili • <i>Adjustable recessed</i>
163	<b>H</b>	Proiettori a binario • <i>Track lights</i>
177	<b>I</b>	Sistemi continui • <i>Continuous line systems</i>
201	<b>L</b>	Industriali e commerciali • <i>Industrial &amp; commercial</i>
227	<b>M</b>	Plafoniere stagne ad alta protezione meccanica • <i>High protection mechanical waterproof fixture</i>



A



B



C



D



E



F



G



H



I



L



M

# INDICE | INDEX

INDICE ILLUSTRATO | ILLUSTRATED INDEX

## **A** **SOSPENSIONE • SUSPENSION | PLAFONE • CEILING** **INCASSO TRIMLESS • RECESSED TRIMLESS | FILE CONTINUE • CONTINUOUS LINE**



Algebra OP  
p. 8



Algebra MP  
p. 9



Algebra Small  
OP p. 10



Algebra Small  
MP p. 11



Algebra Micro  
OP p. 12



Algebra Micro  
MP p. 13



Algebra System  
OP p. 18



Algebra System  
MP p. 19



Algebra System  
Small OP p. 22



Algebra System  
Small MP p. 23



Algebra System  
Micro OP p. 26



Algebra System  
Micro MP p. 27



Giunti Luminosi  
A.S. OP/MP  
p. 20



Giunti Luminosi  
A.S. SMALL OP/MP  
p. 24



Giunti Luminosi  
A.S. MICRO OP/MP  
p. 28

## **B** **SOSPENSIONE • SUSPENSION | PLAFONE • CEILING | PARETE • WALL**



Floating Led  
Dir. p. 40



Floating Led  
Dir./Ind. p. 41



Flat Line Led Dark-  
Dir. p. 42



Flat Line Led Dark-  
Dir./Ind. p. 43



Relax Led Spa  
p. 44



Relax Led Spa R  
p. 45



Relax Led  
p. 46



Relax Led R  
p. 47



BB Teck  
p. 48



BB Led  
p. 49



Flat Smash Led  
p. 50



Gardena Led  
p. 51

# INDICE | INDEX

INDICE ILLUSTRATO | ILLUSTRATED INDEX

## C DECORATIVI A SOSPENSIONE • DECORATIVE SUSPENSION | PLAFONE • CEILING



Basket Led  
Basket Led IP 55  
p. 58-59



Jerrimo  
p. 60



Plato  
p. 61



Luly Shop  
p. 62



Bolero Shop  
p. 63



Coco Led  
p. 64

## D REGLETTE LED "PROLUNGABILI" • LED LIGHT BATTEN "EXTENDABLE



Dedica HF  
p. 70



Dedica ASL HF  
p. 71



Profili HF  
p. 72



Rek Led  
p. 76



Rek Led Sensor  
p. 77

## E INCASSO • RECESSED



Alg Up OP  
p. 90

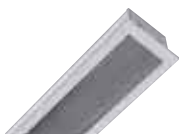

Alg Up MP  
p. 91



Alg Up Small  
OP p. 92



Alg Up Small  
MP p. 93



Alg Up Micro  
OP p. 94



Alg Up Micro  
MP p. 95

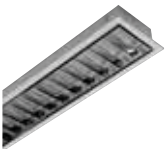

Controlled EB Dark  
p. 96



Controlled EB UGR  
p. 97



Controlled EB  
OPAL p. 98



Controlled SPA  
p. 99



Controlled SPA  
2 Luci p. 100



Controlled SPA R  
p. 101

# INDICE | INDEX

## INDICE ILLUSTRATO | ILLUSTRATED INDEX

### **E** INCASSO • RECESSED



Contro Flat Led  
MP p. 102



Moreflat MP  
p. 103



Controplus UGR  
p. 104



Controplus OPAL  
p. 105



Controplus R  
UGR p. 107



Controplus R  
OPAL p. 108



Compatta UGR  
p. 109



Contro Clip-In  
UGR p. 110

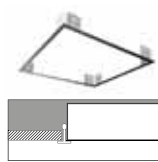

Telai/Frames  
p. 111



Adrian  
p. 112



Adrian UGR  
p. 112

### **F** INCASSO DOWNLIGHT • RECESSED DOWNLIGHT



Clock Led S  
p. 120



Clock Led T  
p. 121



Clock Led MP  
p. 122



New Remisi 230  
(S) p. 124



New Remisi 230  
(M) p. 125



New Remisi 200  
(S) p. 126



New Remisi 200  
(M) p. 127



Doria 230 (VS)  
p. 128



Doria 190 (VS)  
p. 129



Spotled OP  
p. 130



Spotled MP  
p. 131



Inca 150  
p. 132



Inca 125  
p. 133



New White 230  
p. 134



New White 200  
p. 135



New White 150  
p. 136



Enne  
p. 137



Sii  
p. 138

# INDICE | INDEX

## INDICE ILLUSTRATO | ILLUSTRATED INDEX

### G INCASSO ORIENTABILI • ADJUSTABLE RECESSED



Automa Led (1)  
p. 146



Automa Led (2)  
p. 147



Automa Led (3)  
p. 148



Giro Led (1)  
p. 149



Giro Led (2)  
p. 150



Giro Led (3)  
p. 151



Mini Giro  
p. 152



Roller Led  
p. 153



Mini Automa Led (1)  
p. 154



Mini Automa Led (2)  
p. 155



Mini Automa Led (3)  
p. 156



Rumba Led  
p. 157



Flamenko Led  
p. 158



Jwe Led  
p. 159



Mambo Led  
p. 160

### H PROIETTORI A BINARIO • TRACK LIGHTS



Beba  
p. 168



Lerica  
p. 169



Vale  
p. 170



Don  
p. 171



Smile  
p. 172



Binario Dali  
p. 174

# INDICE | INDEX

INDICE ILLUSTRATO | ILLUSTRATED INDEX

## I SISTEMI CONTINUI • CONTINUOUS LINE SYSTEMS



Bingo Led  
p. 182



Bingo System Led  
p. 184



Bingo System  
Led Plus p. 186



Binlens System  
EX p. 188



Binlens System  
ST p. 189



Binlens System  
BT p. 190

## L INDUSTRIALI & COMMERCIALI • INDUSTRIAL & COMMERCIAL

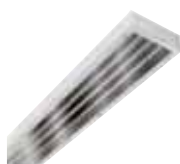

AMBI U  
p. 208

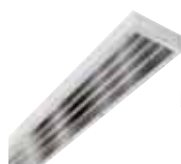

AMBI I  
p. 209



Futura  
p. 210



Futura Plus  
p. 211



Futura Small  
p. 212

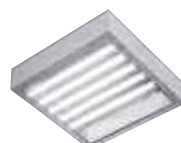

Futura IP55D  
p. 214



Dundi LED  
p. 216



DN Led  
p. 217



Essential COB  
p. 218



Essential  
p. 219



Luly  
p. 220



Bolero  
p. 221



Plike R  
p. 222



Plike Q  
p. 223



Sottile R  
p. 224



Sottile Q  
p. 225

# INDICE | INDEX

INDICE ILLUSTRATO | ILLUSTRATED INDEX

## M PLAFONIERE STAGNE AD ALTA PROTEZIONE MECCANICA HIGH PROTECTION MECHANICAL WATERPROOF FIXTURE

### INNOVA XL



Innova XL 1500  
Satinato/Satin  
p. 234

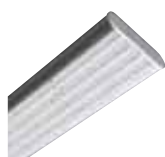

Innova XL 1200  
Satinato/Satin  
p. 235

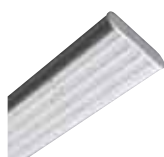

Innova XL 600  
Satinato/Satin  
p. 236



Innova XL 1500  
Opale/Opal  
p. 238



Innova XL 1200  
Opale/Opal  
p. 239



Innova XL  
INTENSIVE  
p. 240

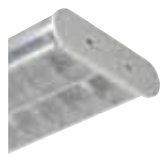

Innova XL DARK  
p. 241



Innova XL  
SAHARA +70°C  
p. 242

### INNOVA



Innova  
VARIO KELVIN®  
p. 246



Innova MEGA 1500  
Satinato/Satin  
p. 250



Innova MEGA 1200  
Satinato/Satin  
p. 251



Innova MEGA 1500  
Opale/Opal  
p. 252



Innova MEGA 1200  
Opale/Opal  
p. 253



Innova MEGA 1500  
Rigato/Ribbed  
p. 254



Innova MEGA 1200  
Rigato/Ribbed  
p. 255



Innova 1500  
Satinato/Satin  
p. 258



Innova 1200  
Satinato/Satin  
p. 259



Innova 600  
Satinato/Satin  
p. 260



Innova 1500  
Opale/Opal  
p. 262



Innova 1200  
Opale/Opal  
p. 263

# INDICE | INDEX

INDICE ILLUSTRATO | ILLUSTRATED INDEX

## **M** PLAFONIERE STAGNE AD ALTA PROTEZIONE MECCANICA HIGH PROTECTION MECHANICAL WATERPROOF FIXTURE



Innova 600  
Opale/Opal  
p. 264



Innova 1500  
Rigato/Ribbed  
p. 266



Innova 1200  
Rigato/Ribbed  
p. 267



Innova 600  
Rigato/Ribbed  
p. 268



Innova INTENSIVE  
p. 272



Innova  
CONCENTRANTE  
p. 273



Innova PARK  
p. 274



Innova  
ASIMMETRICA  
p. 275



Innova ARCTIC  
-25°C + 40°C  
p. 278



Innova ARCTIC  
-40°C + 40°C  
p. 279



Innova SAHARA  
-20°C + 70°C  
p. 280



Innova LONG 3000  
Satinato/Satin  
p. 284



Innova LONG 2400  
Satinato/Satin  
p. 285



Innova LONG 1900  
Satinato/Satin  
p. 286



Innova LONG 3000  
Opale/Opal  
p. 288



Innova LONG 2400  
Opale/Opal  
p. 289



Innova LONG 1900  
Opale/Opal  
p. 290



Innova LONG 3000  
Rigato/Ribbed  
p. 292



Innova LONG 2400  
Rigato/Ribbed  
p. 293



Innova LONG 1900  
Rigato/Ribbed  
p. 294



Innova UT  
Satinato/Satin  
p. 298



Innova UT  
Opale/Opal  
p. 299



Innova 110V  
p. 302



Innova 48V  
p. 303



Innova 24V  
p. 304



# INDICE | *INDEX*

INDICE ILLUSTRATO | *ILLUSTRATED INDEX*

## **M** PLAFONIERE STAGNE AD ALTA PROTEZIONE MECCANICA HIGH PROTECTION MECHANICAL WATERPROOF FIXTURE

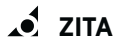

ZITA  
Opale/*Opal*  
p. 320



ZITA RAPID  
Opale/*Opal*  
p. 322



ZITA 3P  
Opale/*Opal*  
p. 324



ZITA 5P  
Opale/*Opal*  
p. 326



ZITA LONG 3P  
Opale/*Opal*  
p. 328



ZITA LONG 5P  
Opale/*Opal*  
p. 330



Una donna è il cerchio che si chiude: sua è la capacità di creare,  
nutrire e trasformare  
*(Diane Mariechild)*



Tutti sanno che una cosa è impossibile da realizzare,  
finché arriva uno sprovveduto che non lo sa e la inventa.  
*(Albert Einstein)*



Lo scienziato descrive ciò che esiste; l'ingegnere crea  
ciò che non era mai stato.  
*(Theodore von Kármán)*

# GRUPPO RAINA

L'unione fa la luce.

**IDEALLUX®**

*Lookup*

**COLOMBO**

IT

## CHI SIAMO

**IL GRUPPO RAINA** è il brand che raggruppa sotto lo stesso nome i marchi:

**IDEALLUX®** produzione storica specializzata nella realizzazione e vendita di apparecchi destinati ai settori dell'industria e del terziario. **COLOMBO** marchio specifico per gli apparecchi stradali, arredo urbano e da esterno. **LOOKUP®** con la sua nuova e ampia gamma di apparecchi decorativi e architettonici.

EN

## WHO WE ARE

**GRUPPO RAINA** is the brand that brings together under the same name:

**IDEALLUX®** historical production specialized in the production and sale of fittings for industry and tertiary. **COLOMBO** brand specific for street and outdoor fixtures. **LOOKUP®** with its wide and new range of decorative lighting fittings.



IT

MISSION

Il gruppo ha come mission la progettazione e la produzione di sistemi di illuminazione, caratterizzati da un'elevata tecnologia e da un ottimo rendimento, totalmente realizzati nello stabilimento di Cilavegna, in Provincia di Pavia e certificati 100% Made in Italy. Gruppo Raina vanta tra le certificazioni ottenute la certificazione ISO 9001:2008 e la certificazione 100% Made in Italy rilasciata dall'Istituto Per la Tutela dei Produttori Italiani. I numeri del gruppo riassumono le capacità dello stesso, con i suoi 12.000 mq di stabilimento produttivo, 7.000 mq di magazzino, 100 risorse impiegate e oltre 3.800 clienti attivi.



EN

MISSION

The group's mission is the design and production of lighting systems characterized from high technology and very good performance, totally made at the Cilavegna plant in the Province of Pavia and certified 100% Made in Italy. The Gruppo Raina obtained the Certification ISO 9001: 2008 and the 100% Made in Italy Certification issued by the Institute for the Protection of Italian Manufacturers. The numbers of the group can explain the capacity of it: 12.000 square meters of production plant, 7.000 sqm of warehouse, 100 resources employed and more than 3.800 active customers.



IT

**RICERCA E SVILUPPO**

In un progetto la fase di acquisizione dei dati, delle necessità e dei gusti del mercato diventa essenziale per la corretta messa a fuoco dell'intero processo ideativo. La struttura tecnica di IDEALLUX®, vasta e integrata nelle sue funzioni e competenze, garantisce l'ottimizzazione del processo progettuale: dalla valutazione del costo industriale alla qualità globale del prodotto. Tutti i processi inerenti alla progettazione vengono gestiti all'interno dell'azienda. La progettazione viene realizzata da personale altamente qualificato che, attraverso l'utilizzo di software avanzati, sviluppa, analizza e progetta il prodotto in tutte le sue parti. La realizzazione di un prototipo, testato nel laboratorio fotometrico, è la parte conclusiva di questo processo. IDEALLUX® è specializzata nella creazione di apparecchi CUSTOM proprio grazie alla capacità di adattare il prodotto alle esigenze del cliente.

EN

**RESEARCH AND DEVELOPMENT**

The data acquisition, market's needs and demands are essential for the proper focus of the idea and development of the project. The wide technical IDEALLUX® structure with its many functions and skills, guarantees the optimization of product design process: starting from the industrial cost evaluation to the overall quality of the product. All the different steps of the design project are managed within the company. Through use of advanced software, the highly qualified IDEALLUX® staff develops, analyzes and designs the product in all its parts. This design process ends with the production of a prototype, tested in the internal photometric laboratory. Thanks to its ability to adapt the product to customer requirements, IDEALLUX® is specialized in the creation of "CUSTOM MADE PRODUCTS".

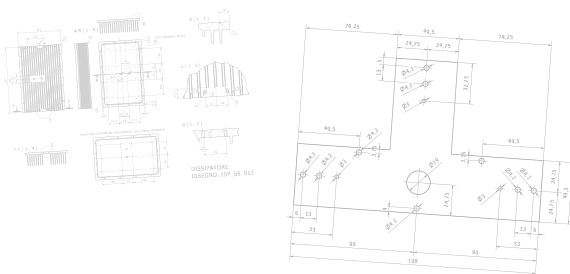

Modellazione 3D | 3D modelling



IT

**MISURE E PROVE**

È nella fase di prototipazione che IDEALLUX® svolge tutti i controlli preventivi sulla sicurezza, qualità, conformità, in relazione alle principali norme di settore. In conformità alla normativa EN 60598 vengono eseguite prove di resistenza termica, attraverso il controllo capillare dei singoli componenti interni, prove di resistenza a IP e IK, attraverso le quali si analizza il comportamento della struttura meccanica alle sollecitazioni esterne, e prove in nebbia salina per verificare la tenuta delle superfici esterne. Grazie al supporto del proprio laboratorio fotometrico, IDEALLUX® può effettuare i più svariati test ottici sugli apparecchi, in conformità alla normativa UNI EN13032, realizzare le curve fotometriche e ampliare la gamma di prodotti attraverso l'ottimizzazione delle ottiche e dei recuperatori di flusso.

EN

**MEASURES AND TESTS**

During prototyping phase IDEALLUX® carries out all the preventive controls of security, quality and conformity according to sector norms. In according to norm EN60598, IDEALLUX® performs a wide range of tests as the thermal resistance test (realized through the controls of each single component), the IP and IK resistance tests (to analyze how the mechanical structure reacts to external stresses), salt spray (fog) test (to check the resistance of the external surfaces). Thanks to the internal photometric laboratory IDEALLUX® can make many optic tests on the fixture, according to norm UNI EN13032, generate photometric curve and extend its range of products through the optimization of optics and flow recovery devices.

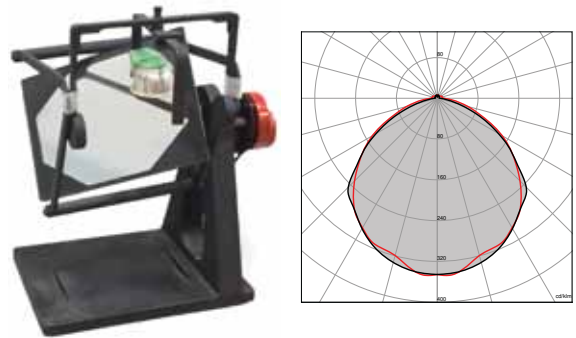

IT

**ASSISTENZA CLIENTI E VERIFICHE ILLUMINOTECNICHE**

IDEALLUX® fornisce ai suoi clienti ed ai progettisti, il servizio di assistenza alla progettazione illuminotecnica.

Mediante l'utilizzo di software avanzati è possibile:

- consultare le caratteristiche fotometriche dell'apparecchio per un'ideale applicazione
- elaborare e calcolare nel dettaglio il livello di illuminamento e di uniformità sui piani di lavoro.
- Negli elaborati ottenuti, sono presenti valori di illuminamento medio (curve isolux).
- Le fotometrie sono disponibili sul sito [www.ideallux.it](http://www.ideallux.it)

EN

**CUSTOMER SERVICE AND LIGHTING CALCULATIONS**

IDEALLUX® provides its customers and designers the lighting calculation service assistance.

Using advance software it is possible:

- To examine the photometric characteristics of fixture for a proper application.
- To elaborate and calculate detailed lighting levels and light uniformity on work surface.
- In lighting calculations there are average lighting values (Isolux curves).
- The photometric curves are available on website [www.ideallux.it](http://www.ideallux.it).



Simulazione illuminamento | *Light simulation*

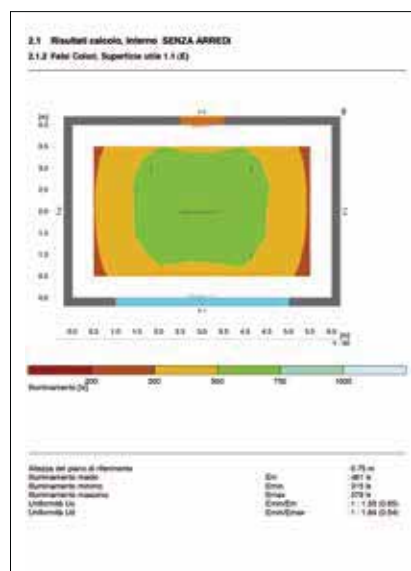
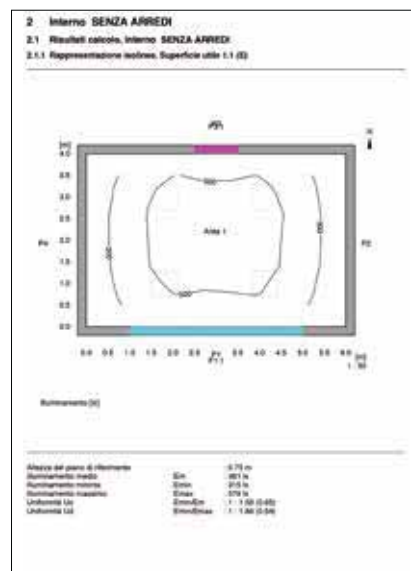
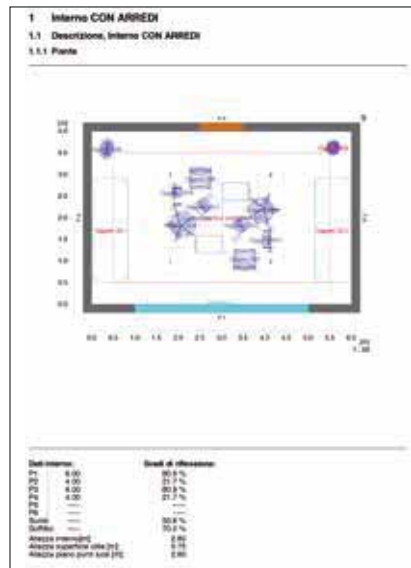



IT

**LED: COS'È E COME FUNZIONA**

La sigla LED è l'acronimo inglese di Light Emitting Diode, diodo a emissione luminosa.

Si tratta di un dispositivo optoelettronico che sfrutta le proprietà ottiche di alcuni materiali semiconduttori di emettere luce blu quando attraversati da una corrente elettrica. I LED utilizzati nell'illuminazione sono realizzati partendo da un diodo in grado di emettere luce blu su cui è applicato uno strato fluorescente (normalmente fosforo) che converte la fonte luminosa in luce bianca. La combinazione di differenti materiali semiconduttori del diodo di base e il tipo di materiale fluorescente applicato, consentono di creare LED con temperatura colore **da 2700K a 6500K ed elevata resa cromatica (fino a CRI>90)**. Sviluppo e ricerca applicate ai LED hanno portato questa tecnologia ad essere la reale alternativa alle fonti di illuminazione tradizionali sia per quantità che per qualità della luce.

EN

**LED: WHAT AND HOW IT WORKS**

LED is the acronym for LIGHT EMISSION DIODE.

This is an optoelectronic device, which uses the optical properties of some semiconductor materials to emit light when electrical current passed through them. The LEDs for lighting are realized starting from one diode, which is able to emit blue light, onto which a fluorescent layer is applied (normally phosphorous) which converts the light source into white light. The combination of different semiconductor materials of the basic diode and the type of the applied fluorescent material creates LED with colour temperature **from 2700 K to 6500 K and high colour rendering (up to CRI>90)**. Development and research applied to LEDs have enabled this technology to be the real alternative to traditional light sources in both light quantity and quality.

LED focus | Focus LED

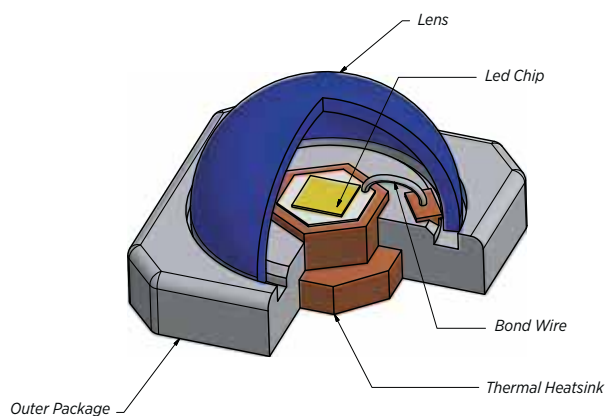

IT

**LED: ASPETTATIVA DI VITA**

Contrariamente a quanto avviene per le lampade tradizionali che tendono a spegnersi improvvisamente a fine vita, nel LED si ha una lenta diminuzione del flusso luminoso iniziale fino al completo esaurimento.

Con l'indicazione "durata di vita" si indica pertanto l'aspettativa di vita utile del LED considerando la luce emessa (in percentuale) al raggiungimento delle ore di funzionamento dichiarate. Questo valore è indicato con la lettera "L". Con la lettera "B" si indica la percentuale di led che potrebbero non garantire il flusso dichiarato. Ad esempio: 50.000h L80/B20 indica che i LED installati avranno un flusso residuo pari all'80% dopo 50.000 ore di funzionamento (L80), e che questo dato è garantito per l'80% dei diodi (B20= 20% di diodi per i quali non è garantita la durata dichiarata).

EN

**LED: LIFE TIME**

Unlike traditional sources LEDs will not turn off suddenly at their working (or service) end of life, but they will slowly decrease their initial luminous flux until they turn off completely.

The words "LIFE TIME" indicates the working life of LEDs considering emitted light (in percentage) up to reaching the number of stated operating hours. This value is indicated with letter "L". The letter "B" indicates the percentage of LEDs which could not guarantee the stated flow. For example: 50.000h L80/B20 indicates that the LEDs installed will have the residual flux equal to 80% after 50.000 working-hours (L80) and this value is guaranteed for 80% of the diodes (B20=20% of the diodes for which the stated working life is not guaranteed).

Esempio durata di vita | Life time example

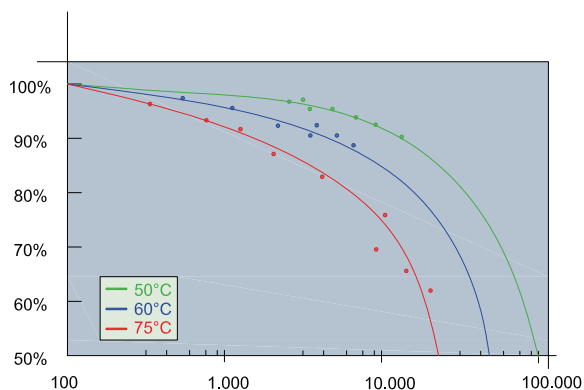

IT

**LED: QUALITÀ DELLA LUCE**

Le caratteristiche dei diodi LED non possono essere completamente previste in fase di realizzazione ma occorre effettuare una selezione dei diodi una volta realizzati. Con Spesso sentiamo parlare di **Binning dei LED**, è il metodo di ordinamento dei chips LED in modo che i LED selezionati in un particolare gruppo di appartenenza abbiano aspetto e caratteristiche simili. La richiesta di LED aventi un binning ridotto (cioè acquistare LED con le caratteristiche simili) si traduce in costi di approvvigionamento maggiori considerando una selezione più accurata. Parlando di qualità della luce è importante introdurre il concetto di consistenza del colore cioè informare l'utilizzatore che due apparecchi con la stessa temperatura di colore (es. 3.000K) possono generare due effetti diversi sulla stessa superficie in termini di colore percepito della luce. Per ovviare a questo problema e per misurare le differenze di colore si è fatto ricorso al sistema basato sulle ellissi di MacAdam. Le ellissi di MacAdam sono descritte come "step" e definiscono come qualsiasi tonalità di colore circoscritta dal perimetro dell'ellisse rispetto ad un riferimento centrale, non è percepita dall'occhio umano anche se strumentalmente presenta differenze.

**Al fine di ottimizzare qualità e uniformità cromatica delle fonti luminose, i LED utilizzati nei prodotti IDEALLUX® sono selezionati per ottenere una precisione pari a 3 Step di MacAdam (3 SDCM - Standard Deviation of Color Matching).**

EN

**LED: LIGHT QUALITY**

During production it is not possible to expect the fully LED diodes characteristics and it is necessary to select the diodes once they are produced. **LED Binning** is way of sorting the chips LED so that all the LEDs from one particular bin look the same and have similar light out. The purchase costs are higher in case of request of LEDs with reduced binning (i.e. purchase LED with similar characteristics). When talking about the quality of light it is important to introduce the concept of color consistency, i.e. to inform the user that two fixtures with the same color temperature (e.g. 3.000K) could generate two different effects on the same surface area in terms of the light color perception. In order to avoid this problem and to measure the differences of color, it is necessary to refer to the system based on MacAdam ellipses. MacAdam ellipses are described as "steps" and they indicate how any color shade circumscribed by the perimeter of the ellipsis compared to a central reference, is indistinguishable to a human eye even if instrumentally it shows differences.

**In order to optimize the quality and chromatic uniformity of light sources, the LED used by IDEALLUX® are selected to achieve a 3 Step MacAdam precision (3 SDCM - Standard Deviation of Color Matching).**



Differenza tra diverse tipologie di sorgenti LED  
*Different LED source lighting*



**TRA I NOSTRI CLIENTI ANNOVERIAMO:  
AMONG OUR CUSTOMERS WE COUNT:**

- Penny market
- Assicurazioni Generali, Milano
- Negozi | Shops Nurith
- Ubi banca
- Mbda, La Spezia
- Negozi | Shops arredamento home plus
- De Rigo Refrigeration
- Ipermercati | Supermarket Coop
- Antony Morato
- Natuzzi Divani
- Brunello Cucinelli
- Negozi | Shops Orofino
- Depositi | Warehouses Comifar
- Piaggio
- Ups logistica | Logistic
- Santo Stefano S.P.A.
- Volkswagen
- Rapitech, Lecco
- Pelletteria Meucci, Scandicci
- Et Engineering&Technology, Perignano
- Favilli Pneumatici, Perignano
- Solettificio Guerrieri, Fucecchio
- Trelleborg
- Negozi | Shops Strolli Oro
- Negozi | Shops Profumerie Limoni
- Indesit
- Maletti group



Politecnico "Lecco"



Yeast Factory salataguse, "Estonia"



Orchid hotel, "Abu Dhabi", uae



Yeast factory Salataguse, "Estonia"



Factory



Yeast factory Salataguse, "Estonia"



Office



Coop Supermarket

## PROGETTI | PROJECTS:

- Castello / *Castle*, Lerici
- Aeroporto | *Airport*, Pisa
- Concessionaria Fiat, Roma
- Palazzo | *Building* INPS , Genova
- Stabilimenti | *Factory* Acqua Oliveto
- Fiera | *Fair* Milano
- Fiera | *Fair* Roma
- Fiera | *Fair* Genova
- Ospedale | *Hospital* San Raffaele, Milano
- Base NATO, Napoli
- Carcere | *Prison* , Parma
- Scuole | *Schools*, Bari
- Politecnico, Lecco
- Istituto Poligrafico dello Stato, Roma
- Stadio | *Stadium* Meazza, Milano
- Stadio del Tennis | *Tennis Stadium*, Roma
- Torre | *Tower* Isozaki, Milano
- Torre | *Tower* Zucchetti, Lodi
- Torre | *Tower* Hadid, Milano
- Nuvola Lavazza, Torino
- Palazzo | *Building* Sky, Milano
- Asilo nido | *Nursery* Guastalla, Monza
- Ospedale | *Hospital* , Alessandria
- B&B Hotel, Sesto San Giovanni
- Aeroporto | *Airport* Namibe, Angola
- Arab Bank Amman, Giordania
- Al Jalila Cultural Center, Dubai UAE
- Bank of Sharjah, UAE

**PROGETTI | PROJECTS:**

- Giordania Mabada & Shuna Clinic, Giordania
- Palazzo | *Palace* Versace Hotel, Dubai UAE
- Dubai International Airport APM, Dubai UAE
- Institute of applied technology, Abu Dhabi UAE
- Arab Ready Food Mela, Giordania
- Khalifa Hospital, Dubai UAE
- Energy city, Doha Qatar
- Ethyad Tower, Abu Dhabi UAE
- Salam Mall, Kuwait
- Custom Buildings, Dubai UAE
- YAS Island Police Station, Abu Dhabi UAE
- Tangram Hotel Erbil, Iraq
- Emirates Bank, Dubai UAE
- Gold's gym, Kuwait
- Ghanima Hospital, Kuwait
- Al Raha Beach Development, Abu Dhabi UAE
- Al Raha Beach Apartments, Abu Dhabi UAE
- Grand Millenium Hotel, Iraq
- Burj Khalifa Tower, Dubai UAE
- Yas Marina Enhancement Main Contract works, Abu Dhabi UAE
- Red Valentino Boutique, Abu Dhabi UAE
- Arab Bank Sharjah Branch UAE
- 7th&8th floors fit-out works - The Gate Tower, Doha Qatar
- Arab Bank Airport Branch Amman, Giordania
- Finance House Tower, Dubai
- Al Ruwais, Abu Dhabi UAE



Ospedale di "Ginevra"



American University Suleiman, "Iraq"



Abacus hotel, "Hungary"



Negozio "Benetton"





Homeplus



Brunello Cucinelli, Doha, "Qatar"



Allied Shopping Center, "Hungary"



Coop Supermarket

**PROGETTI | PROJECTS:**

- Al Ali Villa at West Bay Lagoon, Qatar
- American office Abu Dhabi Airport, Abu Dhabi UAE
- Al Badie Rotana Hotel, Abu Dhabi UAE
- Ambulatory Health Care Center, Abu Dhabi UAE
- Pipe cast factory, Qatar
- Vip Lounge Safat Airport, Kuwait
- Al Gumrok Hotel, Qatar
- Orchid Hotel, Abu Dhabi UAE



Centro sportivo



Villa Serra di Comago (GE)



Waterford Theatre Royale, Ireland



ASK



Torre Dei Balivi Aosta



Homeplus



Ospedale Di Ginevra



Scuole

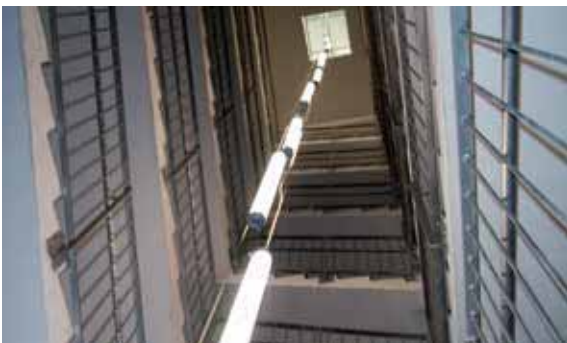

Fiera Milano City



Rho Fiera "Milano"

**ALGEBRA MP - SCHERMO MICROPRISMATO/MICROPRISMATIC DIFFUSER | 9**

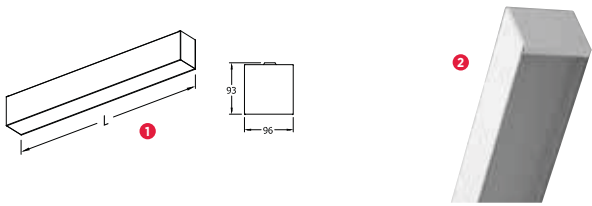

Lunghezze disponibili | Available lengths:  
**762 mm - 1137 mm - 1512 mm**

**ALGEBRA MP**

Apparecchio LED per montaggio a plafone. Montaggio a sospensione o ad incasso trimless a richiesta (kit opzionale, p. 32-34-35). Schermo microprismato. LED lighting fitting for ceiling fixing system. On request suspension or recessed trimless fixing system (Optional Kit, p. 32-34-35). Microprismatic diffuser.

**5Y WARRANTY**  
5% FAILURE RATE

**60.000 h**  
LED LIFETIME L90B10

**100.000 h**  
LED LIFETIME L70B50

**A RICHIESTA | ON REQUEST**

**>90 CRI** **EM** **DALI** **PD PUSH DIM**

	8	9	10	11	12	13	14	15	16	17	18	19
	Relamping	Lumen LED*	Watt LED*	Lumen Out***	Watt	Lumen Watt Out	L. Lunghezza L Length	Configurazione LED LED configuration	Codice Code	K	Alimentazione Power Supply	Colore Colour
1X58		<b>4100</b>	20	2800	21,5	> 130	762 mm	---	<b>AGLMP2020</b>	<b>W</b> 3.000	--- CAE A RICHIESTA   ON REQUEST <b>DL</b> DALI <b>PD</b> PUSH DIM	<b>01</b> bianco white
1X58		<b>4940</b>	25	3153	26,5	> 119	762 mm	---	<b>AGLMP2029</b>	<b>N</b> 4.000	---	---
2X36		<b>6300</b>	30	4225	32,5	> 130	1137 mm	---	<b>AGLMP2030</b>	<b>W</b> 3.000	---	<b>01</b> bianco white
2X36		<b>7360</b>	36,5	4641	39	> 119	1137 mm	---	<b>AGLMP2042</b>	<b>N</b> 4.000	---	---
2X58		<b>8400</b>	40	5551	42,5	> 130	1512 mm	---	<b>AGLMP2039</b>	<b>W</b> 3.000	---	<b>01</b> bianco white
2X58		<b>9880</b>	49	6190	52	> 119	1512 mm	---	<b>AGLMP2057</b>	<b>N</b> 4.000	---	---

TEMPERATURA AMBIENTE MIN E MAX | MIN AND MAX ROOM TEMPERATURE: (-10° +40°)  
 \* Lumen nominali LED max a 25° | Nominal lumen at max 25°  
 \*\* Potenza del LED | LED power  
 \*\*\* Flusso totale in uscita dall'apparecchio a temperatura di lavoro (Ta 25° - 4.000 K) | Total lighting fitting flux output at working temperature (Ta 25° - 4.000 K) (L: 3.000 K: 90% - CRI 90 - 90%)

CE

>80 CRI EN 60598-2-22

IP43 EN 60529

230 V 20143/016

50/60 Hz

IK 07 EN 60529

850° EN 60598-2-22

RG 0 EN 62471

01 WHITE

SELV

19 UGR

CATALOGUE IDEALLUX® 2019 | www.grupporaina.it

- 1 Disegno dimensionale.  
*Dimensional drawing.*
- 2 Immagine prodotto.  
*Product image.*
- 3 Tipo di installazione prevista.  
*Possible applications.*
  - Plafone, superficie | *Ceiling/Wall Surface*
  - Sospensione | *Suspension*
  - Incasso | *Recessed*
  - Incasso downlight | *Recessed downlight*
  - Incasso orientabili | *Adjustable recessed*
  - Proiettori a binario | *Track lights*
- 4 I simboli riportati indicano configurazioni disponibili su richiesta.  
*The symbols identify the available versions on request*

- Possibilità di equipaggiamento utilizzando LED con resa cromatica maggiore di 90.  
*Version with LED with Color Rendering Index >90 available on request.*
- Possibilità di equipaggiamento con modulo di emergenza in conformità con la norma EN 60598-2-22.  
*Emergency Module in accordance with Norm EN 60598-2-22 available on request.*
- Possibilità di equipaggiamento con funzionalità "DALI" (accensione e dimmerazione comandati tramite controllo digitale DALI).  
*DALI function available on request (lighting and dimming controlled by DALI digital control).*
- Possibilità di equipaggiamento con funzionalità "PUSH-DIM" (accensione e dimmerazione comandati tramite pulsante N.A.).  
*PUSH-DIM function available on request (lighting and dimming controlled by n.o. button)*

## CODICE D'ORDINE | ORDER CODE

- 16 **CODICE:**  
è il codice del prodotto da utilizzare per comporre il codice d'ordine.  
(Vedi sezione "codice d'ordine")
- CODE:**  
*it is the article code to be used to compose the order code.*  
(See section "order code")

**AGLMP2029N01**

**CODICE**  
**CODE**

**ALGEBRA MP 27W 4.000K CAE BIANCO**

**K**

**ALIMENTAZIONE**  
**POWER SUPPLY**

**ALGEBRA MP 54W 3.000K DALI BIANCO**

**COLORE**  
**COLOUR**

**AGLMP2057WDL01**

**CODICE**  
**CODE**

**K**

























**COLORE**  
**COLOUR**

- 5 Simbologia caratteristiche tecnico-costruttive vedi dettagli a pagina XXVI.  
*For the symbols of the technical details see on page XXVI.*
- 6 Fotometrie, accessori, caratteristiche costruttive e schemi di cablaggio. Indica la pagina catalogo dedicata per visionare le informazioni.  
*Photometries, accessories, construction characteristics and connection scheme. It identify the pages that contain this information.*
- 7 Informazioni generali e suggerimenti relativi a dati prodotto ed eventuali configurazioni disponibili a richiesta.  
*General information and product data suggestions regarding available version on request.*

## TABELLA CARATTERISTICHE PRODOTTO | PRODUCT CHARACTERISTICS TABLE

<p><b>8 RELAMPING:</b> indica tipo e potenza della fonte di illuminazione tradizionale sostituibile con l'articolo di riferimento.</p>	<p><b>RELAMPING:</b> <i>identify type and power of the traditional lights replaceable with the reference article.</i></p>
<p><b>9 LUMEN LED:</b> è ricavato considerando il valore di flusso medio del LED, a temperatura di giunzione T<sub>j</sub> 25°C, fornito dal costruttore dei diodi, considerando la selezione (BIN) utilizzata e la corrente applicata - tolleranza sui valori indicati +/- 10%. Particolare attenzione e verifiche effettuate dall'ufficio tecnico Ideallux consente di selezionare i prodotti più performanti presenti sul mercato; La continua evoluzione delle performance di LED genera una continua evoluzione del prodotto utilizzato.</p>	<p><b>LUMEN LED:</b> <i>this value is the LED medium flux at joint temperature T<sub>j</sub> 25°C, which is provided by the producer of diodes, considering the selection (BIN) used and applied current - tolerance on indicated values +/- 10%. The particular attention and the tests made by the IDEALLUX technical department allow the selection of products with high performance. The constant evolution of the LED performance creates constant evolution of the used product.</i></p>
<p><b>10 WATT LED:</b> questo dato esprime la potenza nominale di lampada calcolata in base ai valori di V<sub>f</sub> (tensione di funzionamento del LED) forniti dal costruttore dei diodi ed alla corrente di alimentazione utilizzata. L'attento studio dei parametri elettrici dei componenti utilizzati favorisce lo sviluppo di apparecchi altamente performanti.</p>	<p><b>WATT LED:</b> <i>this value identifies the nominal power of the fitting based on the V<sub>f</sub> values (LED working voltage) provided by the producer of the diodes and on the power supply used. The careful study of electrical parameters of the used components allow the development of fitting with high performance</i></p>
<p><b>11 LUMEN OUT:</b> indica il flusso emesso dall'apparecchio in condizioni di lavoro misurate secondo le norme UNI EN 13032-1:2012 e UNI EN 13032-4:2015 operante in ambiente con temperatura pari a 25°C.</p>	<p><b>LUMEN OUT:</b> <i>this value identifies the out flux of the fitting at measured working conditions according to norms UNI EN 13032-1:2012 and UNI EN 13032-4:2015 operating in environments at 25° C temperature</i></p>
<p><b>12 WATT:</b> è la potenza totale assorbita dalla rete elettrica dall'apparecchio di illuminazione. Il dato indicato è comprensivo dei consumi dell'alimentatore elettronico con apparecchio stabilizzato a regime termico operante in ambiente con temperatura pari a 25°C.</p>	<p><b>WATT:</b> <i>it is the total power absorbed by power grid from the lighting fitting. The value includes the power consumption of the power supply with a thermally stabilized device operating in an environment at 25 ° C.</i></p>
<p><b>13 LUMEN / WATT OUT:</b> indica l'efficienza reale dell'apparecchio di illuminazione indicando il flusso in uscita per ogni Watt assorbito dalla rete elettrica. Tolleranza sui valori indicati +/- 10%.</p>	<p><b>LUMEN/WATT OUT:</b> <i>this values identifies the real efficiency of the lighting fitting as it indicates the out flux for each Watt absorbed by power grid. Tolerance on indicated values +/- 10%.</i></p>
<p><b>14 DIMENSIONI:</b> quando presente indica le eventuali varianti dimensionali non riportate sul disegno tecnico.</p>	<p><b>DIMENSIONS:</b> <i>if this data is present, it indicates the possible dimensional variations not indicated on the technical draw</i></p>
<p><b>15 CONFIGURAZIONE LED:</b> indica in modo schematico la disposizione dei moduli LED all'interno dell'apparecchio.</p>	<p><b>LED CONFIGURATIONS:</b> <i>it identifies schematically the layout of the LED modules inside the fitting.</i></p>
<p><b>16 CODICE:</b> è il codice del prodotto da utilizzare per comporre il codice d'ordine (vedi sezione "codice d'ordine").</p>	<p><b>CODE:</b> <i>it is the article code to be used to compose the order code (see section "order code")</i></p>
<p><b>17 K:</b> indica la temperatura di colore dei LED espressa in gradi Kelvin; utilizzare le lettere indicate per completare il codice prodotto; "N" per apparecchio equipaggiato con LED 4.000K (standard) oppure con "W" per apparecchio equipaggiato con LED 3.000K, "C" per apparecchio equipaggiato con LED 6.000K.</p>	<p><b>K:</b> <i>it identifies the colour temperature of the LEDS expressed in Kelvin degrees; use the indicated letter to complete the article code: "N" for the article equipped with LED 4.000K (standard versione) or with "W" for the article equipped with LED 3.000K, "C" for the article equipped with LED 6.000K</i></p>
<p><b>18 ALIMENTAZIONE:</b> identifica il tipo di cablaggio dell'apparecchio. La versione standard prevede alimentazione elettronica CAE; cablaggi speciali dimmerabili sono identificati con: DL alimentatore DALI o PD alimentatore push-dim. La sigla relativa al tipo di alimentazione deve essere utilizzata per comporre il codice apparecchio, i codici che non contengono indicazioni relative al tipo di alimentazione saranno gestiti come standard, quindi CAE.</p>	<p><b>POWER SUPPLY:</b> <i>it identifies the wiring type of the fitting. The standard version has a high frequency (CAE) power supply, special dimmable wirings are identified with: DL - power supply DALI and PD - push-dim power supply. The code relating the type of wiring must be used in the item name otherwise they will be treated as standard high frequency (CAE).</i></p>
<p><b>19 COLORE:</b> è un codice numerico che identifica il colore del corpo dell'apparecchio di illuminazione, il colore è riportato in tabella; esempio: 01=bianco, 02=Nero, 05=grigio, ecc.</p>	<p><b>COLOR:</b> <i>it is a code number. It identifies the color of the lighting fitting body, the color is in the list; Example: 01=white, 02=black, 05=grey, ect.</i></p>



	Certifica che il prodotto è realizzato in ambito della Comunità Europea e ne rispetta le norme di sicurezza vigenti.	<i>It certifies that product has been realized respecting European Community security norms.</i>
	Indica il grado di protezione degli involucri (vedi pag. XXVII)	<i>It shows protection degree of the envelopes (see page XXVII)</i>
	Grado di protezione contro gli impatti meccanici esterni (vedi pag. XXVII)	<i>Degree of Protection against external mechanical impact (see page XXVII)</i>
	Classe di isolamento 1	<i>Isolation class 1</i>
	Classe di isolamento 2	<i>Isolation class 2</i>
	Classe di isolamento 3	<i>Isolation class 3</i>
	Apparecchio idoneo per l'utilizzo in ambienti interni	<i>Fitting suitable for internal environments use</i>
	Apparecchio idoneo per l'utilizzo in ambienti esterni	<i>Fitting suitable for outdoor use</i>
	Apparecchio realizzato con trasformatore di sicurezza in cui tutte le parti in tensione che potrebbero entrare accidentalmente in contatto con l'operatore durante le fasi di manutenzione ed installazione, non contengono tensioni pericolose (<60V massimi a valle dell'alimentatore)	<i>Fitting with safety transformer. All parts under voltage, which may accidentally get in contact with the operator during the maintenance phases and installation, don't contain any dangerous voltage (&lt;60V max downstream of power supply)</i>
	indica le tensioni operative dell'apparecchio	<i>it identifies the operating voltage of the fitting</i>
	indica le frequenze operative dell'apparecchio	<i>It identifies the operating frequencies of the fitting</i>
	Disponibile su richiesta versione con controllo wireless	<i>On request: wireless version available</i>
	Protetto contro scariche elettriche accidentali	<i>Protected against accidental electrical discharges</i>
	Protezione contro le scariche atmosferiche	<i>Surge protector</i>
	Aspettativa di vita LED	<i>LED service Life</i>
	Indice di abbagliamento	<i>Glare index</i>
	Vedi condizioni di vendita (vedi pag. 353)	<i>See general conditions (see page 353)</i>
	Colore Bianco	<i>White colour</i>
	Colore Nero	<i>Black colour</i>
	Colore Oro	<i>Gold colour</i>
	Colore Cromo	<i>Chrome colour</i>
	Colore Grigio	<i>Grey colour</i>
	Colore Satinato	<i>Satin colour</i>
	Colore Grafite	<i>Graphite</i>





Indica che il prodotto è conforme ai requisiti di sicurezza previsti dalle direttive applicabili previste dal regolamento nell'Unione Europea.

Indicates that the product conforms to safety requirements provided by the applied directives of the regulations in the European Union.



Apparecchio idoneo per l'installazione su mobili.

Fitting suitable for the installation in furniture.



Seguito da una cifra indica il grado di resistenza all'urto dell'involucro esterno dell'apparecchio.

When followed by one number, it indicates degree of resistance of the outer shell of the fixture to the impact.

Codice   Code IK	IK00	IK01	IK02	IK03	IK04	IK05	IK06	IK07	IK08	IK09	IK10
Energia di impatto in Joule Impact energy in Joule	-	0,15	0,2	0,35	0,5	0,7	1	2	5	10	20



Indica il grado di protezione alle polveri ad all'acqua dell'apparecchio.

Indicated the protection degree of the fixture against dust and water.

PRIMA CIFRA FIRST NUMBER		SECONDA CIFRA SECOND NUMBER		LETTERA OPZIONALE AGGIUNTIVA ADDITIONAL OPTIONAL LETTER	
Livello	Definizione Definition	Livello	Definizione Definition	Livello	Definizione Definition
<b>IPOX</b>	Nessuna protezione al contatto e ingresso di oggetti. No protection against the contact and entering of objects.	<b>IPX0</b>	Non protetto. Not protected	<b>A</b>	Protetto contro l'accesso con il dorso della mano. Protected against access with the back of the hand.
<b>IP1X</b>	Qualsiasi grande superficie del corpo, come il dorso della mano, ma nessuna protezione contro il contatto intenzionale con una parte del corpo (50mm). Any big body surface, like the back of the hand, but no protection against intentional contact with a body part (50mm).	<b>IPX1</b>	Protetto da caduta verticale di gocce d'acqua. Protected against the vertical fall of water drops.	<b>B</b>	Protetto contro l'accesso con un dito. Protected against access with a finger.
<b>IP2X</b>	Protetto contro corpi solidi di dimensioni superiori a 12mm. Protected against solids over 12mm.	<b>IPX2</b>	Protetto da caduta di gocce d'acqua con inclinazione massima 15°. Protected against water drops with maximum inclination 15°.	<b>C</b>	Protetto contro l'accesso con un attrezzo. Protected against access with a tool.
<b>IP3X</b>	Protetto contro corpi solidi di dimensioni superiori a 2,5mm. Protected against solids over 2,5mm.	<b>IPX3</b>	Protetto dalla pioggia. Protected against rain drops.	<b>D</b>	Protetto contro l'accesso con un filo. Protected against access with a wire.
<b>IP4X</b>	Protetto contro corpi solidi di dimensioni superiori a 1mm. Protected against solids over 1mm.	<b>IPX4</b>	Protetto da spruzzi. Protected against water splashes.		
<b>IP5X</b>	Protetto contro la polvere. Protected against dust.	<b>IPX5</b>	Protetto da getti d'acqua. Protected against water jets.		
<b>IP6X</b>	Totalmente protetto contro la polvere. Entirely protected against dust.	<b>IPX6</b>	Protetto da ondate. Protected against waves.		
		<b>IPX7</b>	Protetto da immersione temporanea. Protected against temporary immersion.		
		<b>IPX8</b>	Protetto da immersione continua. Protected against continuous immersion.		



In accordo al par 6.1 della EN 62471: 2008 i gruppi di rischio (per luce blu) sono definiti come segue:

- RG 0 Rischio Esente**  
 Il concetto di base per la classificazione del gruppo Esente è che la lampada non provoca nessun rischio fotobiologico. Tale requisito è soddisfatto da qualsiasi lampada che non provochi un rischio retinico da luce blu (LB) entro 10.000 s (circa 2,8 h) di esposizione.
- RG 1 Rischio Basso**  
 Il concetto di base per tale classificazione è che la lampada non provoca rischio dovuto a normali limitazioni di funzionamento sull'esposizione. Tale requisito è soddisfatto da qualsiasi lampada che eccede i limiti del Gruppo Esente ma non provochi un rischio retinico da luce blu (LB) entro 100 s di esposizione.
- RG 2 Rischio Moderato**  
 Il concetto di base per la classificazione del Gruppo di Rischio 2 (Rischio Moderato) è che la lampada non provoca un rischio in seguito ad una reazione istintiva guardando sorgenti di luce molto luminose (o in seguito ad una sensazione di disagio termico). Tale requisito è soddisfatto da qualsiasi lampada che eccede i limiti del Gruppo di Rischio1 (Rischio Basso) ma non provochi un rischio retinico da luce blu (LB) entro 0,25 s di esposizione (risposta avversiva).
- RG 3 Rischio Elevato**  
 Il concetto di base per tale classificazione è che la lampada può costituire un rischio anche in seguito a un'esposizione momentanea o breve. Le lampade che superano i limiti del Gruppo di Rischio 2 sono comprese nel Gruppo di Rischio 3 (Rischio Elevato).

RG According to par. 6.1 of EN 62471: 2008 risk groups (for blue light) are defined as follows:

- RG 0 Exempt Risk Group**  
 The basic concept for the classification of Exempt risk group is that the luminaire does not cause any photobiological risk. This requirement is met by any luminaire, which does not cause any retina risk from blue light (BL) within 10,000 s exposure (about 2,8 h).
- RG 1 Low Risk Group**  
 The basic concept for this classification is that the luminaire does not cause any risk due to normal operating limitations at the exposure. This requirement is met by any luminaire, which exceeds the limits of the Exempt Group, however, it does not cause any retina risk from blue light (BL) within 100 s exposure.
- RG 2 Intermediate Risk Group**  
 The basic concept for the Risk Group 2 classification (Intermediate Risk) is that the luminaire does not cause any risk as a result of gut reaction when looking at extremely bright light sources (or as a result of thermal feeling of discomfort). This requirement is met by any luminaire which exceeds the limits of the Risk Group 1 (Low Risk Group), however, it does not cause any retina risk from blue light (BL) within 0,25 s exposure (aversive response).
- RG 3 High Risk**  
 The basic concept for this classification is that the luminaire may cause a risk even as a result of a momentary or brief exposure. The luminaires, which exceed the limits of Risk Group 2 are included into Risk Group 3 (High Risk).



Il Ra (Rendering index) / CRI (Colour Rendering index) indica quanto naturali appaiano i colori degli oggetti da essa illuminati. Apparecchi con indice Ra>80 sono perfetti per l'illuminazione generale di interni ed offrono un ottimo comfort visivo. Per applicazioni dove è necessaria una maggiore definizione dei colori IDEALLUX propone soluzioni con Ra>90.

Ra (Rendering index) / CRI (Colour Rendering index) indicates how natural the colours of the illuminated objects look. The fixtures with Ra>80 are perfect for internal illumination and offer an excellent visual comfort. For the applications, where a higher colour definition is required, IDEALLUX offers solutions with Ra>90.



Indica il grado di autoestinguenza delle materie plastiche secondo gli standard statunitensi UL94. La prova consiste nel misurare il tempo in cui il provino di materiale plastico montato verticalmente di spessore specificato (3-6mm), continua a bruciare dopo che sia stato investito dalla fiamma di un Bunsen per 10 sec.  
Il materiale è classificato **VO** quando la fiamma si estingue entro 10 secondi.  
Il materiale è classificato **V1** quando la fiamma si estingue entro 30 secondi senza gocciolamento.  
Il materiale è classificato **V2** quando la fiamma si estingue entro 30 secondi con gocciolamento.

It indicates the flammability degree of plastic materials according to the USA standards UL94. The test consists in measuring the time it takes a sample of plastic material of a specific thickness (3-6mm), which is vertically mounted, to burn after it has been hit by Bunsen flame for 10 sec.  
The material is classified **VO** when the flame extinguishes within 10 seconds.  
The material is classified **V1** when the flame extinguishes within 30 seconds without dripping.  
The material is classified **V2** when the flame extinguishes within 30 seconds with dripping.



Indica il grado di autoestinguenza delle materie plastiche secondo gli standard CEI 50-11. La prova consiste nel simulare le sollecitazioni termiche che possono essere prodotte dalle sorgenti di calore e di accensione in modo da valutare il pericolo di innesco incendio. La sorgente di calore è filo incandescente di Ø4 mm con temperatura di prova: 650°C, 750°C, 850°C e 960°C. Il filo incandescente è applicato sull'involucro per 30 secondi e fiamma generata deve cessare entro 20 s dalla rimozione del filo; sotto l'involucro deve essere posizionata carta velina che non deve incendiarsi a contatto con eventuali gocce di materiale liquefatto.

It indicates the flammability degree of plastic materials according to CEI 50-11 standards. The test consists in simulating thermal stress which can be caused by heat and ignition sources in order to identify the risk of fire triggering. The heat source is a glow wire of diam. 4 mm with the test temperatures: 650°C, 750°C, 850°C and 960°C. The glow wire is applied onto the shell for 30 seconds and the generated flame has to stop within 20 s from wire removal; vellum paper should be put underneath the shell and it is not supposed to catch fire on coming in contact with any drops of liquefied material.

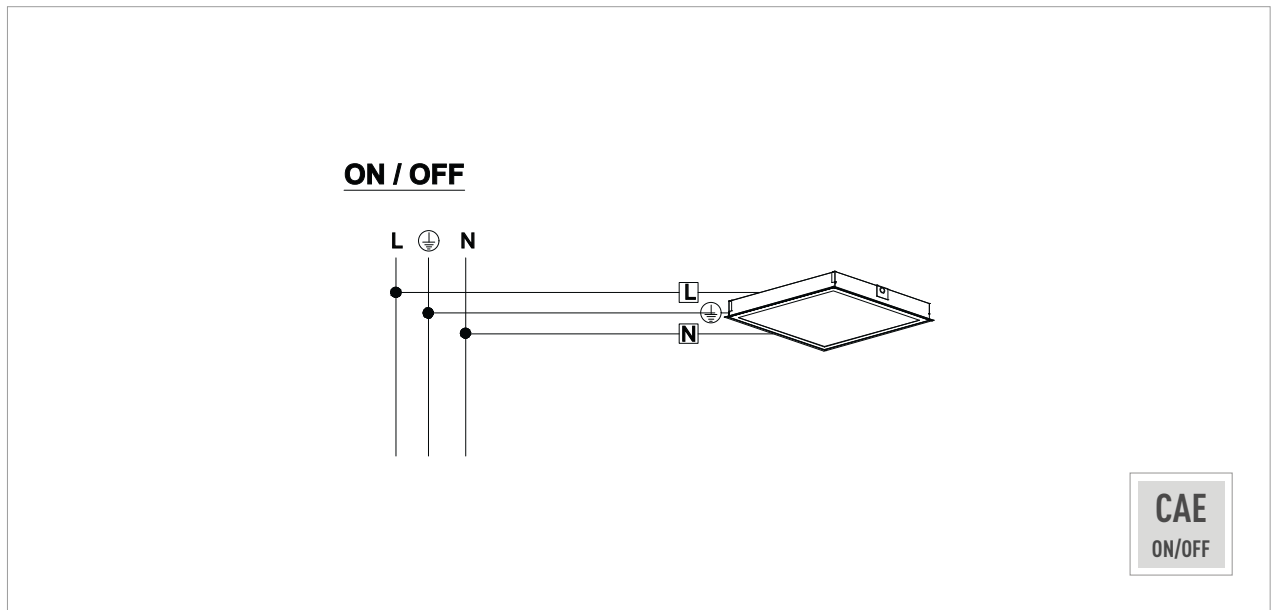

**CAE:**

Schema di collegamento apparecchio standard ON/OFF.  
 Wiring diagram - standard fitting- ON/OFF.

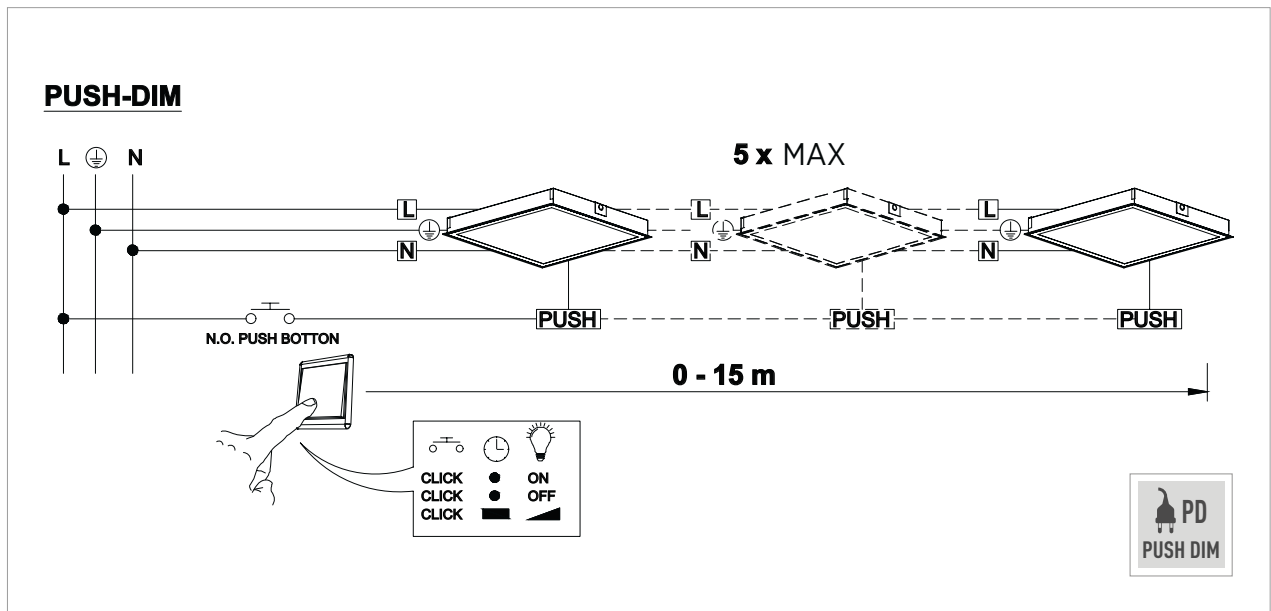

**PUSH-DIM:**

Schema di collegamento per apparecchio PD (cablaggio push-dim).  
 Wiring diagram - Push-dim fitting - PD.

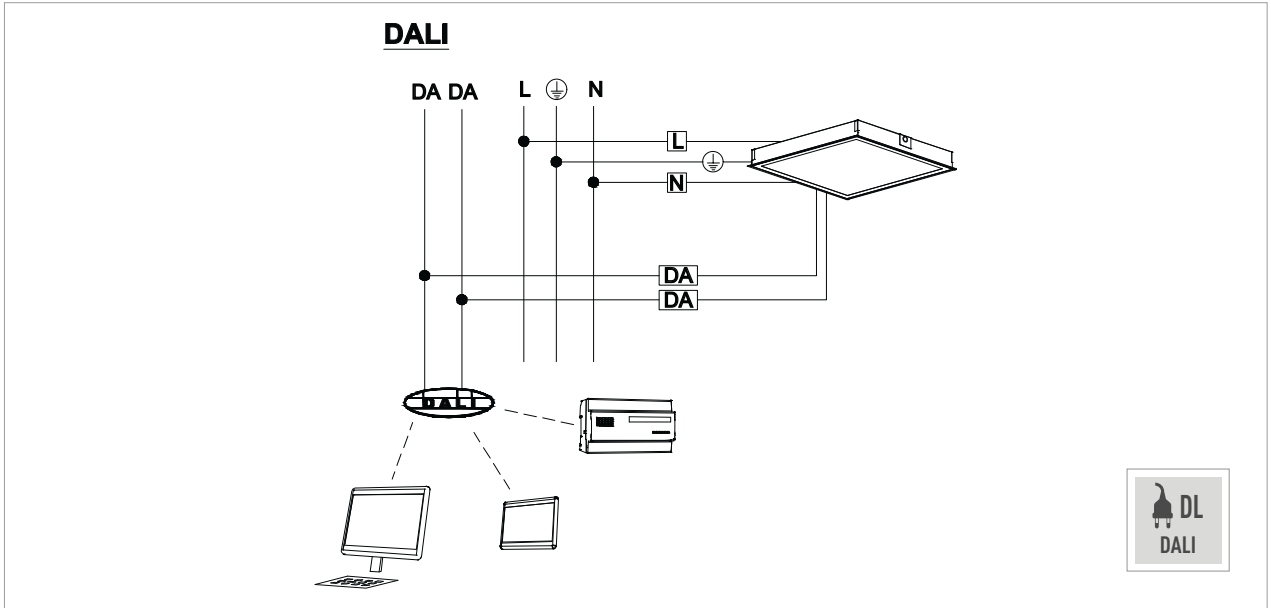

**DALI:**

Schema di collegamento per apparecchio DL (cablaggio DALI).  
 Wiring diagram - DALI fitting - DL.

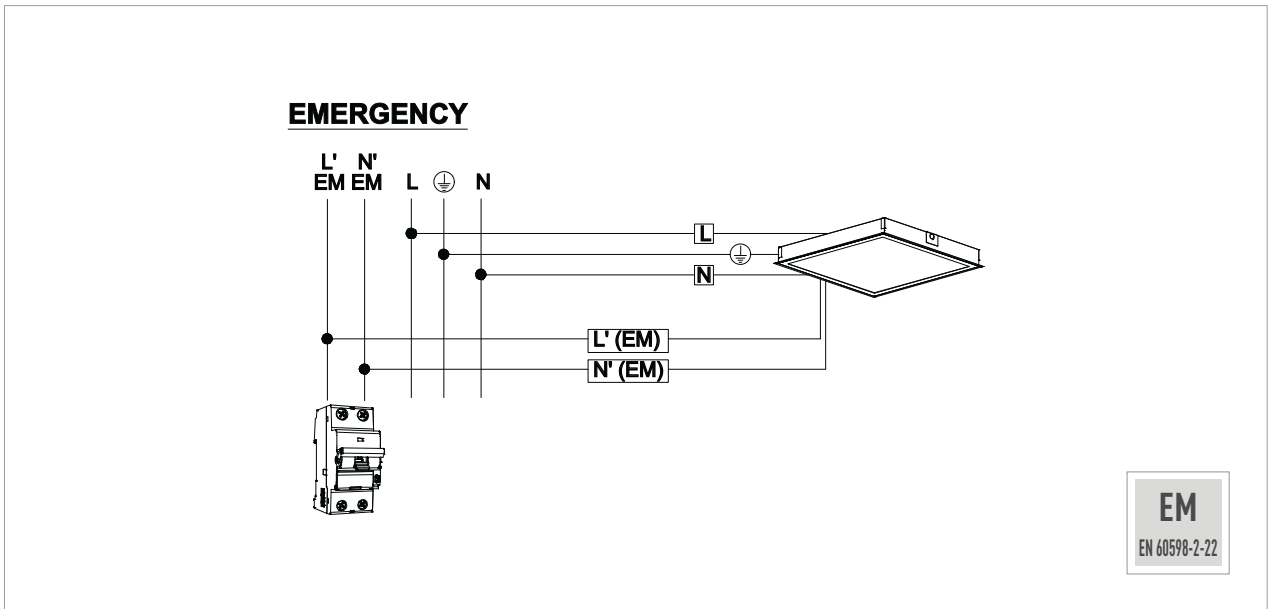

**EM:**

Schema di collegamento per apparecchio con emergenza integrata.  
 Wiring diagram - Emergency fitting - EM.

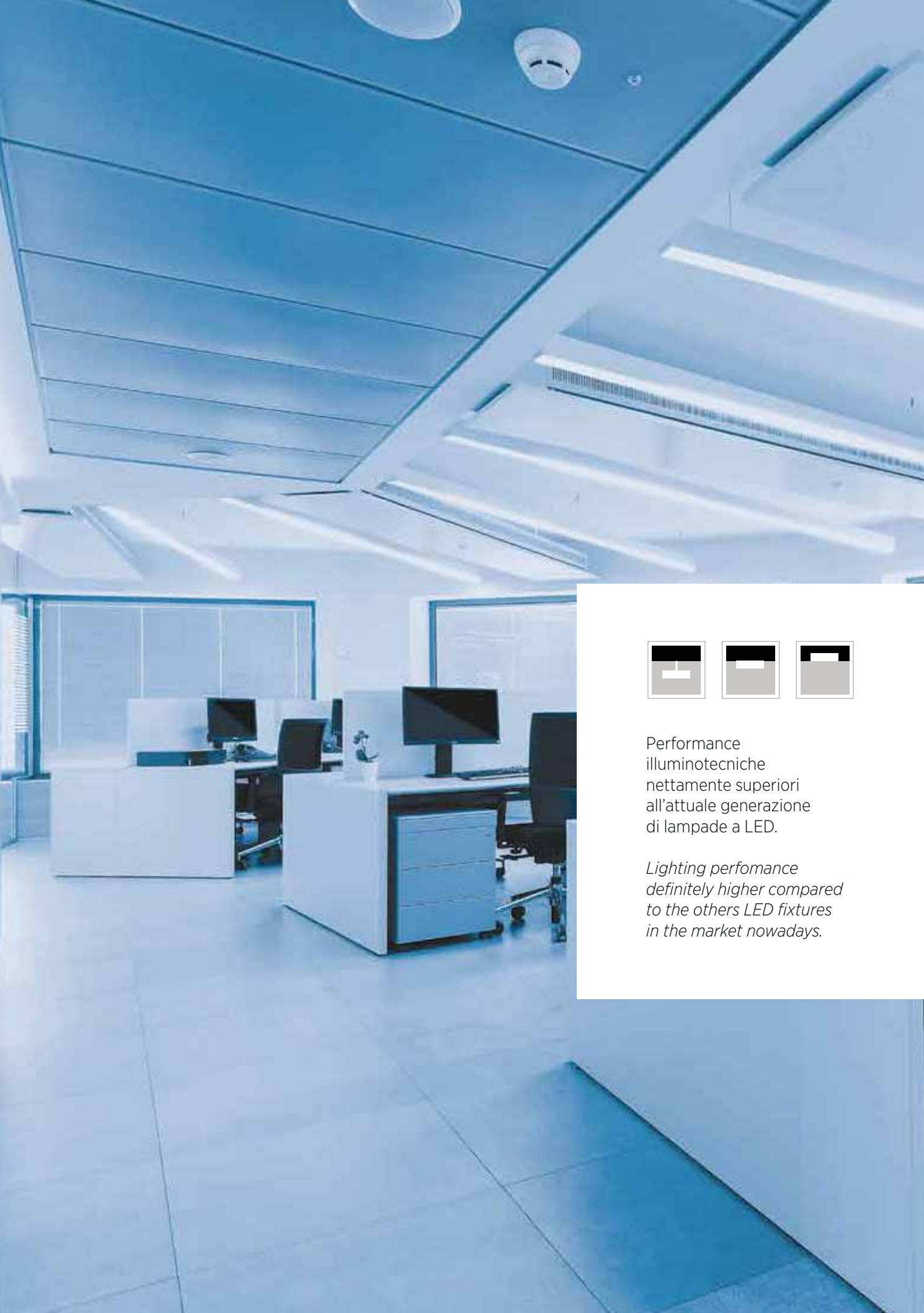

Performance  
illuminotecniche  
nettamente superiori  
all'attuale generazione  
di lampade a LED.

*Lighting performance  
definitely higher compared  
to the others LED fixtures  
in the market nowadays.*



**SOSPENSIONE • SUSPENSION | PLAFONE • CEILING | INCASSO TRIMLESS  
RECESSED TRIMLESS | FILE CONTINUE • CONTINUOUS LINE**

**Sistema di apparecchi illuminotecnici LED per il settore industriale e terziario.**  
LED lighting fixtures system for industries and services.





# GAMMA PRODOTTI | PRODUCT RANGE

SOSPENSIONE • SUSPENSION | PLAFONE • CEILING

INCASSO TRIMLESS • RECESSED TRIMLESS | FILE CONTINUE • CONTINUOUS LINE



## ALGEBRA OP

p. 8

Corpo in lamiera d'acciaio pressopiegata verniciata con polveri epossidiche previa fosfatazione. Ottiche in alluminio ad alto rendimento con funzione di dissipatore. Schermo in policarbonato opale. Sistema di fissaggio a plafone o a sospensione o ad incasso trimless. Testate di chiusura incluse. Sorgente luminosa LED. Emissione diretta. Non idonea per l'applicazione esterna. Alimentazione elettronica CAE. A richiesta: dimmerabile DALI (cod. DL) specificare se con funzione PUSH DIM (cod. PD).

*Bent sheet steel body painted with epoxy powders after phosphating. High performance aluminium louvers with heatsink function. Opal polycarbonate diffuser. Suspension or ceiling fixing system or recessed trimless fixing system. Endcovers included. LED light source. Direct light emission. Not suitable for outdoor application. Built in electronic driver CAE. On request: dimmable DALI (code DL) PUSH DIM function (code PD) to be requested.*



## ALGEBRA SYSTEM OP (FILE CONTINUE • CONTINUOUS LINE)

p. 18

Corpo in lamiera d'acciaio pressopiegata verniciata con polveri epossidiche previa fosfatazione. Ottiche in alluminio ad alto rendimento con funzione di dissipatore. Schermo in policarbonato opale. Sistema di fissaggio a plafone o a sospensione o ad incasso trimless. Testate da ordinare separatamente. Linea passante inclusa. Sorgente luminosa LED. Emissione diretta. Non idonea per l'applicazione esterna. Alimentazione elettronica CAE. A richiesta: dimmerabile DALI (cod. DL) specificare se con funzione PUSH DIM (cod. PD).

*Bent sheet steel body painted with epoxy powders after phosphating. High performance aluminium louvers with heatsink function. Opal polycarbonate diffuser. Suspension or ceiling fixing system or recessed trimless fixing system. Lighting system with through wiring. Endcovers not included, to order separately. LED light source. Direct light emission. Not suitable for outdoor application. Built in electronic driver CAE. On request: dimmable DALI (code DL) PUSH DIM function (code PD) to be requested.*



## ALGEBRA MP

p. 9

Corpo in lamiera d'acciaio pressopiegata verniciata con polveri epossidiche previa fosfatazione. Ottiche in alluminio ad alto rendimento con funzione di dissipatore. Schermo in policarbonato microprismato, idoneo per ambienti con videotermini. Sistema di fissaggio a plafone o a sospensione o ad incasso trimless. Testate di chiusura incluse. Sorgente luminosa LED. Emissione diretta. Non idonea per l'applicazione esterna. Alimentazione elettronica CAE. A richiesta: dimmerabile DALI (cod. DL) specificare se con funzione PUSH DIM (cod. PD).

*Bent sheet steel body painted with epoxy powders after phosphating. High performance aluminium louvers with heatsink function. Microprismatic polycarbonate diffuser, suitable in rooms with VDT. Suspension or ceiling fixing system or recessed trimless fixing system. Endcovers included. LED light source. Direct light emission. Not suitable for outdoor application. Built in electronic driver CAE. On request: dimmable DALI (code DL) PUSH DIM function (code PD) to be requested.*



## ALGEBRA SYSTEM MP (FILE CONTINUE • CONTINUOUS LINE)

p. 19

Corpo in lamiera d'acciaio pressopiegata verniciata con polveri epossidiche previa fosfatazione. Ottiche in alluminio ad alto rendimento con funzione di dissipatore. Schermo in policarbonato microprismato, idoneo per ambienti con videotermini. Sistema di fissaggio a plafone o a sospensione o ad incasso trimless. Testate da ordinare separatamente. Linea passante inclusa. Sorgente luminosa LED. Emissione diretta. Non idonea per l'applicazione esterna. Alimentazione elettronica CAE. A richiesta: dimmerabile DALI (cod. DL) specificare se con funzione PUSH DIM (cod. PD).

*Bent sheet steel body painted with epoxy powders after phosphating. High performance aluminium louvers with heatsink function. Microprismatic polycarbonate diffuser, suitable in rooms with VDT. Suspension or ceiling fixing system or recessed trimless fixing system. Lighting system with through wiring. Endcovers not included, to order separately. LED light source. Direct light emission. Not suitable for outdoor application. Built in electronic driver CAE. On request: dimmable DALI (code DL) PUSH DIM function (code PD) to be requested.*



## GIUNTI LUMINOSI (FILE CONTINUE • CONTINUOUS LINE)

p. 20

Corpo in lamiera d'acciaio pressopiegata verniciata con polveri epossidiche previa fosfatazione. Ottiche in alluminio ad alto rendimento con funzione di dissipatore. Schermo in policarbonato microprismato (cod. MP)/opale (cod. OP). Sistema di fissaggio a plafone o a sospensione o ad incasso trimless. Linea passante inclusa. Sorgente luminosa LED. Emissione diretta. Non idonea per l'applicazione esterna. Alimentazione elettronica CAE. A richiesta: dimmerabile DALI (cod. DL) specificare se con funzione PUSH DIM (cod. PD).

*Bent sheet steel body painted with epoxy powders after phosphating. High performance aluminium louvers with heatsink function. Microprismatic (code MP) or opal (code OP) polycarbonate diffuser. Suspension or ceiling fixing system or recessed trimless fixing system. Lighting system with through wiring. LED light source. Direct light emission. Not suitable for outdoor application. Built in electronic driver CAE. On request: dimmable DALI (code DL) PUSH DIM function (code PD) to be requested.*



# FOTOMETRIE | PHOTOMETRIES

**SOSPENSIONE • SUSPENSION | PLAFONE • CEILING**  
**INCASSO TRIMLESS • RECESSED TRIMLESS | FILE CONTINUE • CONTINUOUS LINE**

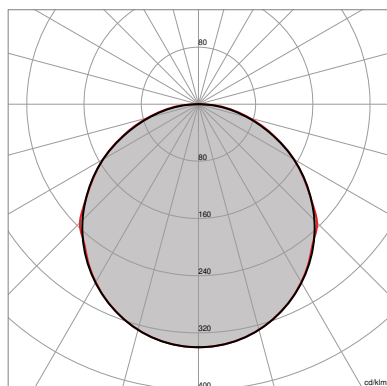

**ALGEBRA OP**

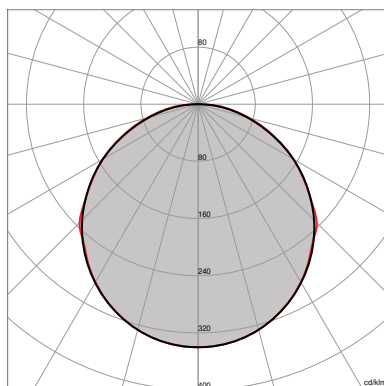

**ALGEBRA SYSTEM OP**

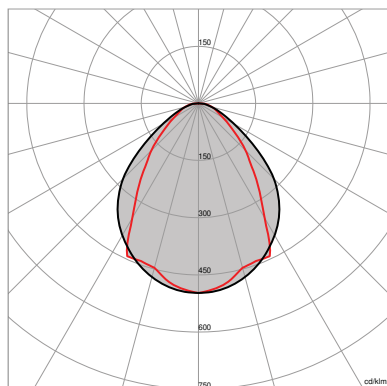

**ALGEBRA MP**

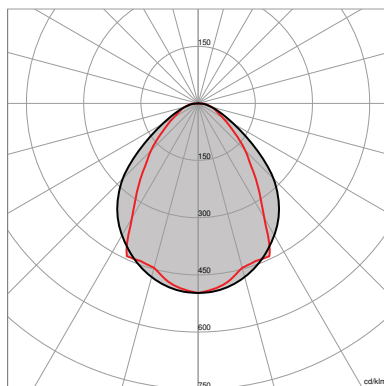

**ALGEBRA SYSTEM MP**

## GIUNTI LUMINOSI | LUMINOUS JOINT

File fotometriche disponibili su richiesta, per maggiori informazioni contattare l'ufficio tecnico.  
 Photometric files available on request, for more information contact the technical office.

Rimani aggiornato  
 Keep up to date



# GAMMA PRODOTTI | PRODUCT RANGE

**SOSPENSIONE • SUSPENSION | PLAFONE • CEILING**  
**INCASSO TRIMLESS • RECESSED TRIMLESS | FILE CONTINUE • CONTINUOUS LINE**



## ALGEBRA SMALL OP

p. 10

Corpo in lamiera d'acciaio pressopiegata verniciata con polveri epossidiche previa fosfatazione. Ottiche in alluminio ad alto rendimento con funzione di dissipatore. Fissaggio a scatto (senza viti) per una facile e veloce installazione. Schermo diffondente in policarbonato opale. Sistema di fissaggio a plafone o a sospensione o ad incasso trimless. Testate di chiusura incluse. Sorgente luminosa LED. Emissione diretta. Non idonea per l'applicazione esterna. Alimentazione elettronica CAE. A richiesta: dimmerabile DALI (cod. DL) specificare se con funzione PUSH DIM (cod. PD).

*Bent sheet steel body painted with epoxy powders after phosphating. High performance aluminium louvers with heatsink function. Opal polycarbonate wide beam diffuser. Suspension or ceiling snap-fastening system without screws for an easy installation or recessed trimless fixing system. Endcovers included. LED light source. Direct light emission. Not suitable for outdoor application. Built in electronic driver CAE. On request: dimmable DALI (code DL) PUSH DIM function (code PD) to be requested.*



## ALGEBRA SYSTEM SMALL OP (FILE CONTINUE • CONTINUOUS LINE)

p. 22

Corpo in lamiera d'acciaio pressopiegata verniciata con polveri epossidiche previa fosfatazione. Ottiche in alluminio ad alto rendimento con funzione di dissipatore. Fissaggio a scatto (senza viti) per una facile e veloce installazione. Schermo diffondente in policarbonato opale. Sistema di fissaggio a plafone o a sospensione o ad incasso trimless. Testate da ordinare separatamente. Linea passante inclusa. Sorgente luminosa LED. Emissione diretta. Non idonea per l'applicazione esterna. Alimentazione elettronica CAE. A richiesta: dimmerabile DALI (cod. DL) specificare se con funzione PUSH DIM (cod. PD).

*Bent sheet steel body painted with epoxy powders after phosphating. High performance aluminium louvers with heatsink function. Opal polycarbonate wide beam diffuser. Suspension or ceiling snap-fastening system without screws for an easy installation or recessed trimless fixing system. Lighting system with through wiring. Endcovers not included, to order separately. LED light source. Direct light emission. Not suitable for outdoor application. Built in electronic driver CAE. On request: dimmable DALI (code DL) PUSH DIM function (code PD) to be requested.*



## ALGEBRA SMALL MP

p. 11

Corpo in lamiera d'acciaio pressopiegata verniciata con polveri epossidiche previa fosfatazione. Ottiche in alluminio ad alto rendimento con funzione di dissipatore. Fissaggio a scatto (senza viti) per una facile e veloce installazione. Schermo diffondente in policarbonato microprismato. Sistema di fissaggio a plafone o a sospensione o ad incasso trimless. Testate di chiusura incluse. Sorgente luminosa LED. Emissione diretta. Non idonea per l'applicazione esterna. Alimentazione elettronica CAE. A richiesta: dimmerabile DALI (cod. DL) specificare se con funzione PUSH DIM (cod. PD).

*Bent sheet steel body painted with epoxy powders after phosphating. High performance aluminium louvers with heatsink function. Microprismatic polycarbonate wide beam diffuser. Suspension or ceiling snap-fastening system without screws for an easy installation or recessed trimless fixing system. Endcovers included. LED light source. Direct light emission. Not suitable for outdoor application. Built in electronic driver CAE. On request: dimmable DALI (code DL) PUSH DIM function (code PD) to be requested.*



## ALGEBRA SYSTEM SMALL MP (FILE CONTINUE • CONTINUOUS LINE)

p. 23

Corpo in lamiera d'acciaio pressopiegata verniciata con polveri epossidiche previa fosfatazione. Ottiche in alluminio ad alto rendimento con funzione di dissipatore. Fissaggio a scatto (senza viti) per una facile e veloce installazione. Schermo diffondente in policarbonato microprismato. Sistema di fissaggio a plafone o a sospensione o ad incasso trimless. Testate da ordinare separatamente. Linea passante inclusa. Sorgente luminosa LED. Emissione diretta. Non idonea per l'applicazione esterna. Alimentazione elettronica CAE. A richiesta: dimmerabile DALI (cod. DL) specificare se con funzione PUSH DIM (cod. PD).

*Bent sheet steel body painted with epoxy powders after phosphating. High performance aluminium louvers with heatsink function. Microprismatic (code MP) or opal (code OP) polycarbonate diffuser. Suspension or ceiling snap-fastening system without screws for an easy installation or recessed trimless fixing system. Lighting system with through wiring. Endcovers not included, to order separately. LED light source. Direct light emission. Not suitable for outdoor application. Built in electronic driver CAE. On request: dimmable DALI (code DL) PUSH DIM function (code PD) to be requested.*



## GIUNTI LUMINOSI (FILE CONTINUE • CONTINUOUS LINE)

p. 24

Corpo in lamiera d'acciaio pressopiegata verniciata con polveri epossidiche previa fosfatazione. Ottiche in alluminio ad alto rendimento con funzione di dissipatore. Schermo in policarbonato microprismato (cod. MP)/opale (cod. OP). Sistema di fissaggio a plafone o a sospensione o ad incasso trimless. Linea passante inclusa. Sorgente luminosa LED. Emissione diretta. Non idonea per l'applicazione esterna. Alimentazione elettronica CAE. A richiesta: dimmerabile DALI (cod. DL) specificare se con funzione PUSH DIM (cod. PD).

*Bent sheet steel body painted with epoxy powders after phosphating. High performance aluminium louvers with heatsink function. Microprismatic (code MP) or opal (code OP) polycarbonate diffuser. Suspension or ceiling fixing system or recessed trimless fixing system. Lighting system with through wiring. LED light source. Direct light emission. Not suitable for outdoor application. Built in electronic driver CAE. On request: dimmable DALI (code DL) PUSH DIM function (code PD) to be requested.*





# FOTOMETRIE | PHOTOMETRIES

**SOSPENSIONE • SUSPENSION | PLAFONE • CEILING**  
**INCASSO TRIMLESS • RECESSED TRIMLESS | FILE CONTINUE • CONTINUOUS LINE**

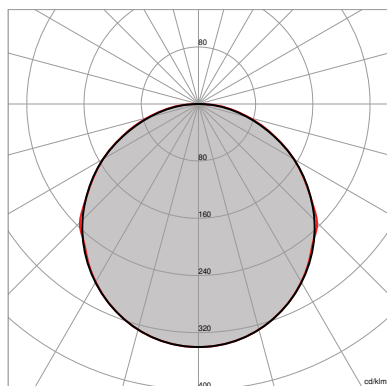

**ALGEBRA SMALL OP**

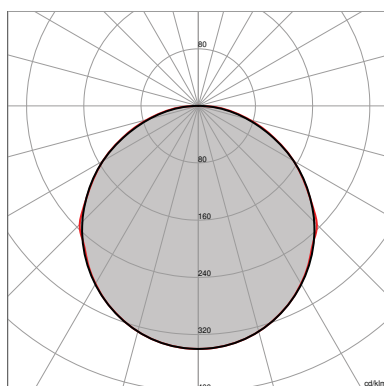

**ALGEBRA SYSTEM SMALL OP**

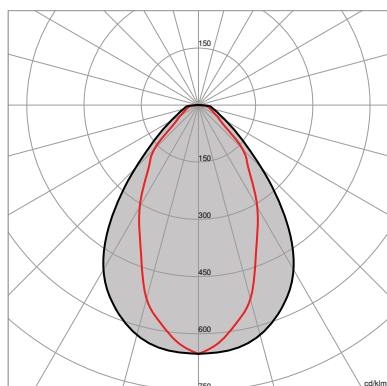

**ALGEBRA SMALL MP**

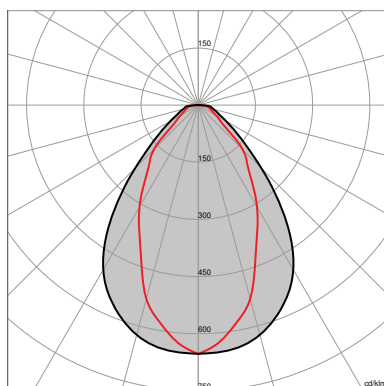

**ALGEBRA SYSTEM SMALL MP**

## GIUNTI LUMINOSI | LUMINOUS JOINT

File fotometriche disponibili su richiesta, per maggiori informazioni contattare l'ufficio tecnico.  
 Photometric files available on request, for more information contact the technical office.

# GAMMA PRODOTTI | PRODUCT RANGE

SOSPENSIONE • SUSPENSION | PLAFONE • CEILING

INCASSO TRIMLESS • RECESSED TRIMLESS | FILE CONTINUE • CONTINUOUS LINE



## ALGEBRA MICRO OP

p. 12

Corpo in lamiera d'acciaio pressopiegata verniciata con polveri epossidiche previa fosfatazione. Ottiche in alluminio ad alto rendimento con funzione di dissipatore. Fissaggio a scatto (senza viti) per una facile e veloce installazione. Schermo in policarbonato opale. Sistema di fissaggio a plafone o a sospensione o ad incasso trimless. Testate di chiusura incluse. Sorgente luminosa LED. Emissione diretta. Non idonea per l'applicazione esterna. Alimentazione elettronica CAE. A richiesta: dimmerabile DALI (cod. DL) specificare se con funzione PUSH DIM (cod. PD).

*Bent sheet steel body painted with epoxy powders after phosphating. High performance aluminium louvers with heatsink function. Opal polycarbonate diffuser. Suspension or ceiling snap-fastening system without screws for an easy installation or recessed trimless fixing system. Endcovers included. LED light source. Direct light emission. Not suitable for outdoor application. Built in electronic driver CAE. On request: dimmable DALI (code DL) PUSH DIM function (code PD) to be requested.*



## ALGEBRA SYSTEM MICRO OP (FILE CONTINUE • CONTINUOUS LINE)

p. 26

Corpo in lamiera d'acciaio pressopiegata verniciata con polveri epossidiche previa fosfatazione. Ottiche in alluminio ad alto rendimento con funzione di dissipatore. Fissaggio a scatto (senza viti) per una facile e veloce installazione. Schermo in policarbonato opale. Sistema di fissaggio a plafone o a sospensione o ad incasso trimless. Testate da ordinare separatamente. Linea passante inclusa. Sorgente luminosa LED. Emissione diretta. Non idonea per l'applicazione esterna. Alimentazione elettronica CAE. A richiesta: dimmerabile DALI (cod. DL) specificare se con funzione PUSH DIM (cod. PD).

*Bent sheet steel body painted with epoxy powders after phosphating. High performance aluminium louvers with heatsink function. Opal polycarbonate diffuser. Suspension or ceiling snap-fastening system without screws for an easy installation or recessed trimless fixing system. Lighting system with through wiring. Endcovers not included, to order separately. LED light source. Direct light emission. Not suitable for outdoor application. Built in electronic driver CAE. On request: dimmable DALI (code DL) PUSH DIM function (code PD) to be requested.*



## ALGEBRA MICRO MP

p. 13

Corpo in lamiera d'acciaio pressopiegata verniciata con polveri epossidiche previa fosfatazione. Ottiche in alluminio ad alto rendimento con funzione di dissipatore. Fissaggio a scatto (senza viti) per una facile e veloce installazione. Schermo in policarbonato microprismatico. Sistema di fissaggio a plafone o a sospensione o ad incasso trimless. Testate di chiusura incluse. Sorgente luminosa LED. Emissione diretta. Non idonea per l'applicazione esterna. Alimentazione elettronica CAE. A richiesta: dimmerabile DALI (cod. DL) specificare se con funzione PUSH DIM (cod. PD).

*Bent sheet steel body painted with epoxy powders after phosphating. High performance aluminium louvers with heatsink function. Microprismatic polycarbonate diffuser. Suspension or ceiling snap-fastening system without screws for an easy installation or recessed trimless fixing system. Endcovers included. LED light source. Direct light emission. Not suitable for outdoor application. Built in electronic driver CAE. On request: dimmable DALI (code DL) PUSH DIM function (code PD) to be requested.*



## ALGEBRA SYSTEM MICRO MP (FILE CONTINUE • CONTINUOUS LINE)

p. 27

Corpo in lamiera d'acciaio pressopiegata verniciata con polveri epossidiche previa fosfatazione. Ottiche in alluminio ad alto rendimento con funzione di dissipatore. Fissaggio a scatto (senza viti) per una facile e veloce installazione. Schermo in policarbonato microprismatico. Sistema di fissaggio a plafone o a sospensione o ad incasso trimless. Apparecchio system con cablaggio passante. Testate da ordinare separatamente. Linea passante inclusa. Sorgente luminosa LED. Emissione diretta. Non idonea per l'applicazione esterna. Alimentazione elettronica CAE. A richiesta: dimmerabile DALI (cod. DL) specificare se con funzione PUSH DIM (cod. PD).

*Bent sheet steel body painted with epoxy powders after phosphating. High performance aluminium louvers with heatsink function. Microprismatic (code MP) or opal (code OP) polycarbonate diffuser. Suspension or ceiling fixing system without screws for an easy installation or recessed trimless fixing system. Lighting system with through wiring. Endcovers not included, to order separately. LED light source Direct light emission. Not suitable for outdoor application. Built in electronic driver CAE. On request: dimmable DALI (code DL) PUSH DIM function (code PD) to be requested.*



## GIUNTI LUMINOSI (FILE CONTINUE • CONTINUOUS LINE)

p. 28

Corpo in lamiera d'acciaio pressopiegata verniciata con polveri epossidiche previa fosfatazione. Ottiche in alluminio ad alto rendimento con funzione di dissipatore. Schermo in policarbonato microprismatico (cod. MP)/opale (cod. OP). Sistema di fissaggio a plafone o a sospensione o ad incasso trimless. Linea passante inclusa. Sorgente luminosa LED. Emissione diretta. Non idonea per l'applicazione esterna. Alimentazione elettronica CAE. A richiesta: dimmerabile DALI (cod. DL) specificare se con funzione PUSH DIM (cod. PD).

*Bent sheet steel body painted with epoxy powders after phosphating. High performance aluminium louvers with heatsink function. Microprismatic (code MP) or opal (code OP) polycarbonate diffuser. Suspension or ceiling fixing system or recessed trimless fixing system. Lighting system with through wiring. LED light source. Direct light emission. Not suitable for outdoor application. Built in electronic driver CAE. On request: dimmable DALI (code DL) PUSH DIM function (code PD) to be requested.*



# FOTOMETRIE | PHOTOMETRIES

**SOSPENSIONE • SUSPENSION | PLAFONE • CEILING**  
**INCASSO TRIMLESS • RECESSED TRIMLESS | FILE CONTINUE • CONTINUOUS LINE**

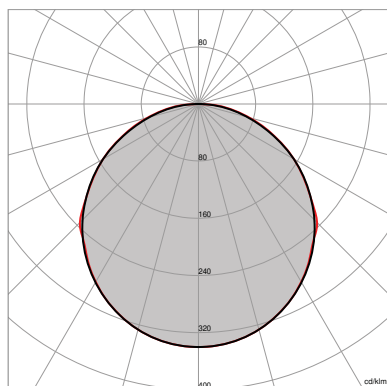

**ALGEBRA MICRO OP**

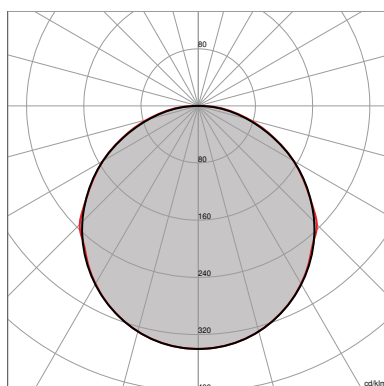

**ALGEBRA SYSTEM MICRO OP**

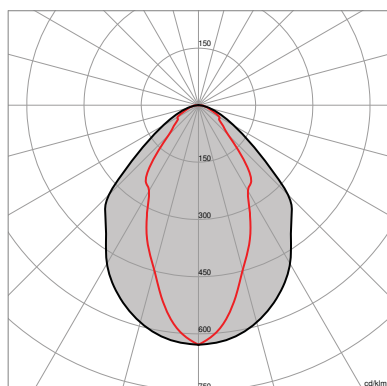

**ALGEBRA MICRO MP**

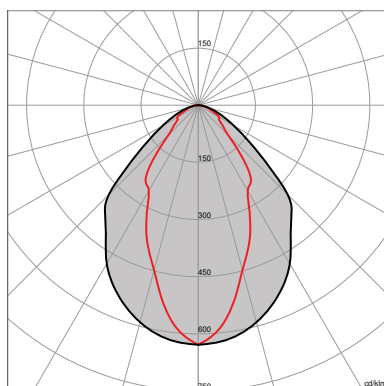

**ALGEBRA SYSTEM MICRO MP**

## GIUNTI LUMINOSI | LUMINOUS JOINT

File fotometriche disponibili su richiesta, per maggiori informazioni contattare l'ufficio tecnico.  
 Photometric files available on request, for more information contact the technical office.

Rimani aggiornato  
 Keep up to date



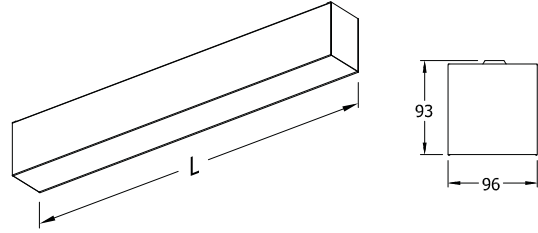
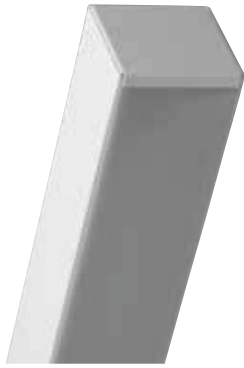

Lunghezze disponibili | Available lengths:  
762 mm - 1137 mm - 1512 mm

# ALGEBRA OP

Apparecchio LED per montaggio a plafone. Montaggio a sospensione o ad incasso trimless a richiesta (kit opzionale, p. 30, 32-33). Schermo opale.  
LED lighting fitting for ceiling fixing system. On request suspension or recessed trimless fixing system (Optional Kit, p. 30, 32-33). Opal diffuser.



A RICHIESTA | ON REQUEST

<b>5Y WARRANTY</b> 5% FAILURE RATE	<b>60.000 h</b> LED LIFETIME L90B10	<b>100.000 h</b> LED LIFETIME L70B50
---------------------------------------	--	---

>90 CRI	EM EN 60910-2-22	DL DALI	PD PUSH DIM
------------	---------------------	------------	----------------

Relamping	Lumen LED*	Watt LED**	Lumen Out***	Watt	Lumen Watt Out	L Lunghezza L Length	Configurazione LED LED configuration	Codice Code	K	Alimentazione Power Supply	Colore Colour
1X36	<b>4100</b>	20	2365	21,5	> 110	762 mm	_____	<b>AGLO2020</b>	W: 3.000	— : CAE A RICHIESTA   ON REQUEST	<b>01:</b> bianco white
1X36	<b>4940</b>	25	2592	26,5	> 98	762 mm	_____	<b>AGLO2029</b>	N: 4.000	DL: DALI PD: PUSH DIM	
1X58	<b>6300</b>	30	3598	32,5	> 110	1137 mm	_____	<b>AGLO2030</b>	W: 3.000	— : CAE A RICHIESTA   ON REQUEST	<b>01:</b> bianco white
1X72	<b>7380</b>	36,5	3838	39	> 98	1137 mm	_____	<b>AGLO2042</b>	N: 4.000	DL: DALI PD: PUSH DIM	
2X36	<b>8400</b>	40	4675	42,5	> 110	1512 mm	_____	<b>AGLO2039</b>	W: 3.000	— : CAE A RICHIESTA   ON REQUEST	<b>01:</b> bianco white
2X36	<b>9880</b>	49	5096	52	> 98	1512 mm	_____	<b>AGLO2057</b>	N: 4.000	DL: DALI PD: PUSH DIM	

CE	⊕	>80 CRI	IP43 EN 60529	230 V 2014/35/UE	50/60 Hz	IK 07 EN 60668
850° EN 60695	A++ A+ A	RG 0 EN 62471	01 WHITE	SELV		

TEMPERATURA AMBIENTE MIN E MAX | MIN AND MAX ROOM TEMPERATURE: (-10° +40°)

\* Lumen nominali LED max a 25° | Nominal lumen at max 25°  
 \*\* Potenza dei LED | LED power  
 \*\*\* Flusso totale in uscita dall'apparecchio a temperatura di lavoro (Ta 25° - 4.000 K) | Total lighting fitting flux output at working temperature (Ta 25° - 4.000 K) | (3.000 K -8% - CRI 90 -10%)



Fotometrie | Photometries  
p. 3



Schema di cablaggio | Connection scheme  
p. XXVIII-XXIX



Descrizione prodotto | Product description  
p. 2



Accessori | Accessories  
p. 30, 32-33

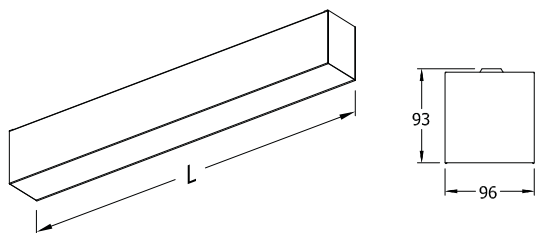

Lunghezze disponibili | Available lengths:  
762 mm - 1137 mm - 1512 mm

# ALGEBRA MP



Apparecchio LED per montaggio a plafone. Montaggio a sospensione o ad incasso trimless a richiesta (kit opzionale, p. 30, 32-33). Schermo microprismato. LED lighting fitting for ceiling fixing system. On request suspension or recessed trimless fixing system (Optional Kit, p. 30, 32-33). Microprismatic diffuser.

**A RICHIESTA | ON REQUEST**



<b>5Y WARRANTY</b> 5% FAILURE RATE	<b>60.000 h</b> LED LIFETIME L90B10	<b>100.000 h</b> LED LIFETIME L70B50
---------------------------------------	--	---

Relamping	Lumen LED*	Watt LED**	Lumen Out***	Watt	Lumen Watt Out	L Lunghezza L Length	Configurazione LED LED configuration	Codice Code	K	Alimentazione Power Supply	Colore Colour
1X58	<b>4100</b>	20	2800	21,5	> 130	762 mm	_____	<b>AGLMP2020</b>	W: 3.000	— : CAE A RICHIESTA   ON REQUEST	<b>01:</b> bianco white
1X58	<b>4940</b>	25	3153	26,5	> 119	762 mm	_____	<b>AGLMP2029</b>	N: 4.000	DL: DALI PD: PUSH DIM	<b>01:</b> bianco white
2X36	<b>6300</b>	30	4225	32,5	> 130	1137 mm	_____	<b>AGLMP2030</b>	W: 3.000	— : CAE A RICHIESTA   ON REQUEST	<b>01:</b> bianco white
2X36	<b>7360</b>	36,5	4641	39	> 119	1137 mm	_____	<b>AGLMP2042</b>	N: 4.000	DL: DALI PD: PUSH DIM	<b>01:</b> bianco white
2X58	<b>8400</b>	40	5551	42,5	> 130	1512 mm	_____	<b>AGLMP2039</b>	W: 3.000	— : CAE A RICHIESTA   ON REQUEST	<b>01:</b> bianco white
2X58	<b>9880</b>	49	6190	52	> 119	1512 mm	_____	<b>AGLMP2057</b>	N: 4.000	DL: DALI PD: PUSH DIM	<b>01:</b> bianco white

TEMPERATURA AMBIENTE MIN E MAX | MIN AND MAX ROOM TEMPERATURE: (-10° +40°)

\* Lumen nominali LED max a 25° | Nominal lumen at max 25°  
 \*\* Potenza dei LED | LED power  
 \*\*\* Flusso totale in uscita dall'apparecchio a temperatura di lavoro (Ta 25° - 4.000 K) | Total lighting fitting flux output at working temperature (Ta 25° - 4.000 K) | (3.000 K -8% - CRI 90 -10%)

CE	⏚	>80 CRI	IP43 EN 60529	230 V 2014/35/UE	50/60 Hz	IK 07 EN 60068
850° EN 60695	A++ A+ A	RG 0 EN 62471	🏠	01 WHITE	SELV	19 UGR



Accessori | Accessories p. 30, 32-33



Descrizione prodotto | Product description p. 2



Schema di cablaggio | Connection scheme p. XXVIII-XXIX



Fotometrie | Photometries p. 3

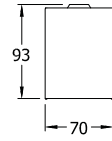
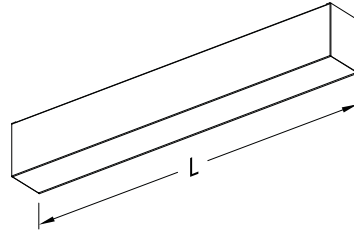

Lunghezze disponibili | Available lengths:  
762 mm - 1137 mm - 1512 mm

# ALGEBRA SMALL OP

Apparecchio LED per montaggio a plafone. Montaggio a sospensione o ad incasso trimless a richiesta (kit opzionale, p. 30, 32-33). Schermo opale.  
LED lighting fitting for ceiling fixing system. On request suspension or recessed trimless fixing system (Optional Kit, p. 30, 32-33). Opal diffuser.



A RICHIESTA | ON REQUEST

<b>5Y WARRANTY</b> 5% FAILURE RATE	<b>60.000 h</b> LED LIFETIME L90B10	<b>100.000 h</b> LED LIFETIME L70B50
---------------------------------------	--	---

>90 CRI	EM EN 60910-2-22	DL DALI	PD PUSH DIM
------------	---------------------	------------	----------------

Relamping	Lumen LED*	Watt LED**	Lumen Out***	Watt	Lumen Watt Out	L Lunghezza L Length	Configurazione LED LED configuration	Codice Code	K	Alimentazione Power Supply	Colore Colour
1X14	<b>2050</b>	10	1190	11	> 108	762 mm	_____	<b>ASMO2010</b>	W: 3.000	— : CAE A RICHIESTA   ON REQUEST	<b>01:</b> bianco white
1X18	<b>2870</b>	15,5	1580	16,5	> 96	762 mm	_____	<b>ASMO2014</b>	N: 4.000	DL: DALI PD: PUSH DIM	
1X28	<b>3075</b>	15,5	1782	16	> 108	1137 mm	_____	<b>ASMO2015</b>	W: 3.000	— : CAE A RICHIESTA   ON REQUEST	<b>01:</b> bianco white
1X28	<b>4300</b>	23,5	2400	25	> 96	1137 mm	_____	<b>ASMO2021</b>	N: 4.000	DL: DALI PD: PUSH DIM	
1X35	<b>4100</b>	20,5	2376	22	> 108	1512 mm	_____	<b>ASMO2020</b>	W: 3.000	— : CAE A RICHIESTA   ON REQUEST	<b>01:</b> bianco white
1X35	<b>5730</b>	31	3170	33	> 96	1512 mm	_____	<b>ASMO2029</b>	N: 4.000	DL: DALI PD: PUSH DIM	

CE	⊕	>80 CRI	IP43 EN 60529	230 V 2014/35/UE	50/60 Hz	IK 07 EN 60608
850° EN 60695	A++ A+ A	RG 0 EN 62471	01 WHITE	SELV		

TEMPERATURA AMBIENTE MIN E MAX | MIN AND MAX ROOM TEMPERATURE: (-10° +40°)

\* Lumen nominali LED max a 25° | Nominal lumen at max 25°

\*\* Potenza dei LED | LED power

\*\*\* Flusso totale in uscita dall'apparecchio a temperatura di lavoro (Ta 25° - 4.000 K) | Total lighting fitting flux output at working temperature (Ta 25° - 4.000 K) | (3.000 K -8% - CRI 90 -10%)



Fotometrie | Photometries  
p. 5



Schema di cablaggio | Connection scheme  
p. XXVIII-XXIX



Descrizione prodotto | Product description  
p. 4



Accessori | Accessories  
p. 30, 32-33



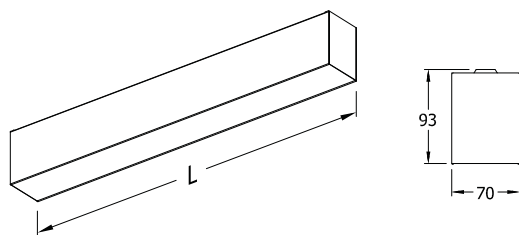

Lunghezze disponibili | Available lengths:  
762 mm - 1137 mm - 1512 mm

# ALGEBRA SMALL MP



Apparecchio LED per montaggio a plafone. Montaggio a sospensione o ad incasso trimless a richiesta (kit opzionale, p. 30, 32-33). Schermo microprismato. LED lighting fitting for ceiling fixing system. On request suspension or recessed trimless fixing system (Optional Kit, p. 30, 32-33). Microprismatic diffuser.

A RICHIESTA | ON REQUEST



<b>5Y WARRANTY</b> 5% FAILURE RATE	<b>60.000 h</b> LED LIFETIME L90B10	<b>100.000 h</b> LED LIFETIME L70B50
---------------------------------------	--	---

Relamping	Lumen LED*	Watt LED**	Lumen Out***	Watt	Lumen Watt Out	L Lunghezza L Length	Configurazione LED LED configuration	Codice Code	K	Alimentazione Power Supply	Colore Colour
1X24	<b>2050</b>	10	1354	11	> 123	762 mm	_____	<b>ASMMP2010</b>	W: 3.000	— : CAE A RICHIESTA   ON REQUEST	<b>01:</b> bianco white
1X24	<b>2870</b>	15,5	1895	16,5	> 115	762 mm	_____	<b>ASMMP2014</b>	N: 4.000	DL: DALI PD: PUSH DIM	
1X28	<b>3075</b>	15,5	2030	16,5	> 123	1137 mm	_____	<b>ASMMP2015</b>	W: 3.000	— : CAE A RICHIESTA   ON REQUEST	<b>01:</b> bianco white
1X36	<b>4300</b>	23,5	2875	25	> 115	1137 mm	_____	<b>ASMMP2021</b>	N: 4.000	DL: DALI PD: PUSH DIM	
1X35	<b>4100</b>	20,5	2576	22	> 108	1512 mm	_____	<b>ASMMP2020</b>	W: 3.000	— : CAE A RICHIESTA   ON REQUEST	<b>01:</b> bianco white
1X58	<b>5730</b>	31	3795	33	> 115	1512 mm	_____	<b>ASMMP2029</b>	N: 4.000	DL: DALI PD: PUSH DIM	

TEMPERATURA AMBIENTE MIN E MAX | MIN AND MAX ROOM TEMPERATURE: (-10° +40°)

\* Lumen nominali LED max a 25° | Nominal lumen at max 25°

\*\* Potenza dei LED | LED power

\*\*\* Flusso totale in uscita dall'apparecchio a temperatura di lavoro (Ta 25° - 4.000 K) | Total lighting fitting flux output at working temperature (Ta 25° - 4.000 K) | (3.000 K -8% - CRI 90 -10%)

CE	⊕	>80 CRI	IP43 EN 60529	230 V 2014/35/UE	50/60 Hz	IK 07 EN 60068
850° EN 60695	A++ A+	RG 0 EN 62471	🏠	01 WHITE	SELV	21 UGR



Accessori | Accessories  
p. 30, 32-33



Descrizione prodotto | Product description  
p. 4



Schema di cablaggio | Connection scheme  
p. XXVIII-XXIX



Fotometrie | Photometries  
p. 5

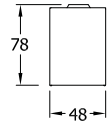
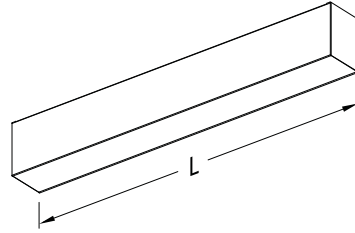

Lunghezze disponibili | Available lengths:  
762 mm - 1137 mm - 1512 mm

# ALGEBRA MICRO OP

Apparecchio LED per montaggio a plafone. Montaggio a sospensione o ad incasso trimless a richiesta (kit opzionale, p. 30, 32-33). Schermo opale.  
LED lighting fitting for ceiling fixing system. On request suspension or recessed trimless fixing system (Optional Kit, p. 30, 32-33). Opal diffuser.



A RICHIESTA | ON REQUEST

<b>5Y WARRANTY</b> 5% FAILURE RATE	<b>60.000 h</b> LED LIFETIME L90B10	<b>100.000 h</b> LED LIFETIME L70B50
---------------------------------------	--	---

>90 CRI	EM EN 60910-2-22	DL DALI	PD PUSH DIM
------------	---------------------	------------	----------------

Relamping	Lumen LED*	Watt LED**	Lumen Out***	Watt	Lumen Watt Out	L Lunghezza L Length	Configurazione LED LED configuration	Codice Code	K	Alimentazione Power Supply	Colore Colour
1X24	<b>2050</b>	10	1190	11	> 108	762 mm	_____	<b>AMCO2010</b>	W: 3.000	— : CAE A RICHIESTA   ON REQUEST	<b>01:</b> bianco white
1X24	<b>2870</b>	15,5	1580	16,5	> 96	762 mm	_____	<b>AMCO2014</b>	N: 4.000	DL: DALI PD: PUSH DIM	
1X28	<b>3075</b>	15,5	1732	16,5	> 108	1137 mm	_____	<b>AMCO2015</b>	W: 3.000	— : CAE A RICHIESTA   ON REQUEST	<b>01:</b> bianco white
1X28	<b>4300</b>	23,5	2400	25	> 96	1137 mm	_____	<b>AMCO2021</b>	N: 4.000	DL: DALI PD: PUSH DIM	
1X35	<b>4100</b>	20,5	2376	22	> 108	1512 mm	_____	<b>AMCO2020</b>	W: 3.000	— : CAE A RICHIESTA   ON REQUEST	<b>01:</b> bianco white
1X35	<b>5730</b>	31	3170	33	> 96	1512 mm	_____	<b>AMCO2029</b>	N: 4.000	DL: DALI PD: PUSH DIM	

CE	⊕	>80 CRI	IP43 EN 60529	230 V 2014/35/UE	50/60 Hz	IK 07 EN 60608
850° EN 60695	A++ A+ A	RG 0 EN 62471	🏠	01 WHITE	SELV	

TEMPERATURA AMBIENTE MIN E MAX | MIN AND MAX ROOM TEMPERATURE: (-10° +40°)

\* Lumen nominali LED max a 25° | Nominal lumen at max 25°

\*\* Potenza dei LED | LED power

\*\*\* Flusso totale in uscita dall'apparecchio a temperatura di lavoro (Ta 25° - 4.000 K) | Total lighting fitting flux output at working temperature (Ta 25° - 4.000 K) | (3.000 K -8% - CRI 90 -10%)



Fotometrie | Photometries  
p. 7



Schema di cablaggio | Connection scheme  
p. XXVIII-XXIX



Descrizione prodotto | Product description  
p. 6



Accessori | Accessories  
p. 30, 32-33

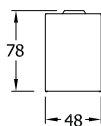
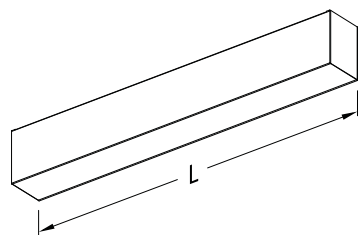

Lunghezze disponibili | Available lengths:  
762 mm - 1137 mm - 1512 mm

# ALGEBRA MICRO MP

Apparecchio LED per montaggio a plafone. Montaggio a sospensione o ad incasso trimless a richiesta (kit opzionale, p. 30, 32-33). Schermo microprismato. LED lighting fitting for ceiling fixing system. On request suspension or recessed trimless fixing system (Optional Kit, p. 30, 32-33). Microprismatic diffuser.



A RICHIESTA | ON REQUEST



<b>5Y WARRANTY</b> 5% FAILURE RATE	<b>60.000 h</b> LED LIFETIME L90B10	<b>100.000 h</b> LED LIFETIME L70B50
---------------------------------------	--	---

Relamping	Lumen LED*	Watt LED**	Lumen Out***	Watt	Lumen Watt Out	L Lunghezza L Length	Configurazione LED LED configuration	Codice Code	K	Alimentazione Power Supply	Colore Colour
1x24	<b>2050</b>	10	1354	11	> 123	762 mm	_____	<b>AMCMP2010</b>	W: 3.000	— : CAE A RICHIESTA   ON REQUEST	<b>01:</b> bianco white
1x24	<b>2870</b>	15,5	1895	16,5	> 115	762 mm	_____	<b>AMCMP2014</b>	N: 4.000	DL: DALI PD: PUSH DIM	
1x28	<b>3075</b>	15,5	2030	16,5	> 123	1137 mm	_____	<b>AMCMP2015</b>	W: 3.000	— : CAE A RICHIESTA   ON REQUEST	<b>01:</b> bianco white
1x36	<b>4300</b>	23,5	2875	25	> 115	1137 mm	_____	<b>AMCMP2021</b>	N: 4.000	DL: DALI PD: PUSH DIM	
1x35	<b>4100</b>	20,5	2576	22	> 108	1512 mm	_____	<b>AMCMP2020</b>	W: 3.000	— : CAE A RICHIESTA   ON REQUEST	<b>01:</b> bianco white
1x35	<b>5730</b>	31	3795	33	> 115	1512 mm	_____	<b>AMCMP2029</b>	N: 4.000	DL: DALI PD: PUSH DIM	

TEMPERATURA AMBIENTE MIN E MAX | MIN AND MAX ROOM TEMPERATURE: (-10° +40°)

\* Lumen nominali LED max a 25° | Nominal lumen at max 25°

\*\* Potenza dei LED | LED power

\*\*\* Flusso totale in uscita dall'apparecchio a temperatura di lavoro (Ta 25° - 4.000 K) | Total lighting fitting flux output at working temperature (Ta 25° - 4.000 K) | (3.000 K -8% - CRI 90 -10%)

CE	⊕	>80 CRI	IP43 EN 60529	230 V 2014/35/UE	50/60 Hz	IK 07 EN 60068
850° EN 60695	A++ A+ A	RG 0 EN 62471	🏠	01 WHITE	SELV	21 UGR



Accessori | Accessories  
p. 30, 32-33



Descrizione prodotto | Product description  
p. 6



Schema di cablaggio | Connection scheme  
p. XXVIII-XXIX



Fotometrie | Photometries  
p. 7

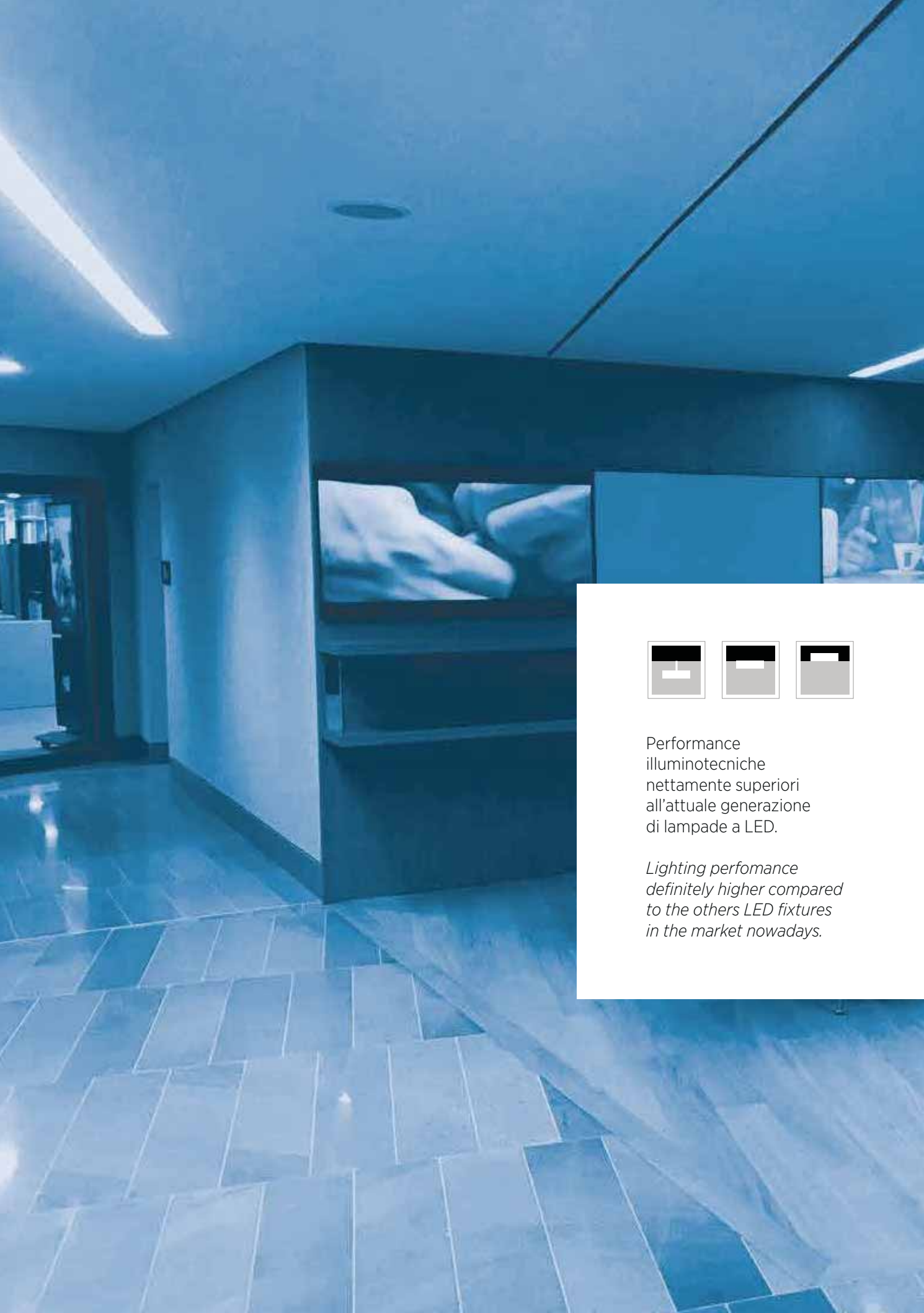

Performance  
illuminotecniche  
nettamente superiori  
all'attuale generazione  
di lampade a LED.

*Lighting performance  
definitely higher compared  
to the others LED fixtures  
in the market nowadays.*



## ALGEBRA SYSTEM

**Sistema di apparecchi illuminotecnici LED per il settore industriale e terziario.**  
LED lighting fixtures system for industries and services.





**CAVO D'ALIMENTAZIONE PASSANTE A 5 POLI**  
**5-POLES POWER THROUGH CABLE**

- 1= DL | EM NEUTRO/NEUTRAL
- 2= DL | EM FASE/PHASE

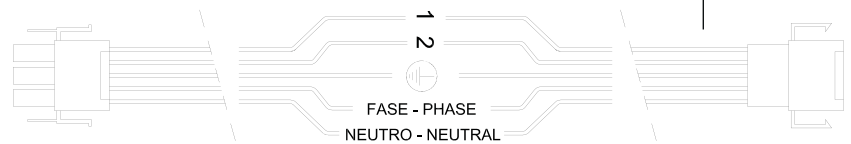

**Riflettore in alluminio** ad alto rendimento  
con funzione di dissipatore.

*High performance **aluminum reflector** with  
heat sink function.*

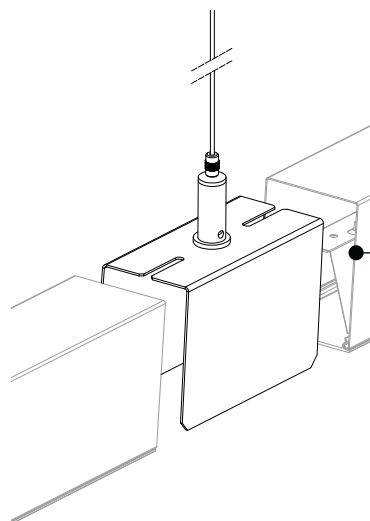

Sistema sospensione su giunto a scomparsa.  
(Kit sospensione fornito separatamente).  
Adatto per apparecchi "L" max 1510 mm

*Suspension fixing system on hidden joint.  
(Suspension kit supplied separately).  
Suitable for fittings  
"L" max 1510 mm*





Corpo illuminante.  
*Lighting fitting.*



Giunto lineare.  
*Linear joint.*



Giunto angolare 90°.  
*Angle joint 90°.*



Giunto angolare tre vie.  
*Three-way angle joint.*

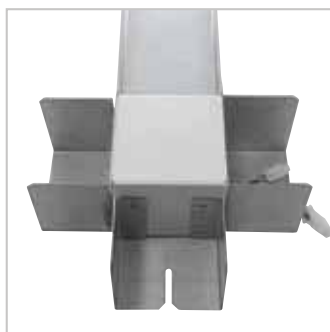

Giunto angolare quattro vie.  
*Four-way angle joint.*



Testata di chiusura.  
*Endcover.*

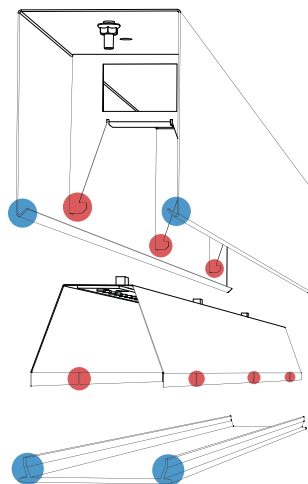

**SISTEMA DI MONTAGGIO A SCATTO SENZA UTILIZZO DI VITI ED UTENSILI**

(Disponibile su Algebra small e Algebra micro).

**SNAP-FASTENING SYSTEM WITHOUT USE OF SCREWS AND TOOLS**

(Available for algebra small and algebra micro).

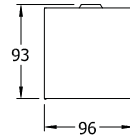
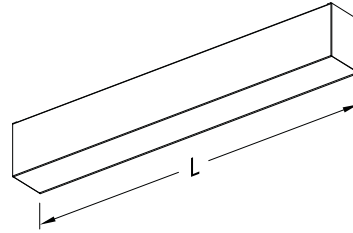
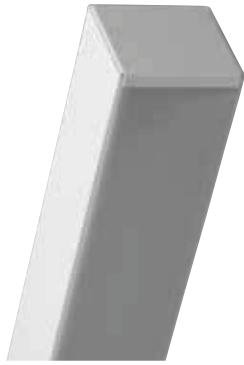

Lunghezze disponibili | Available lengths:  
760 mm - 1135 mm - 1510 mm

# ALGEBRA SYSTEM OP

Apparecchio LED per montaggio in fila continua a plafone. Montaggio a sospensione o ad incasso trimless a richiesta (kit opzionale, p. 30, 32-33). Schermo opale.  
LED lighting fitting for continuous line for ceiling fixing system. On request suspension or recessed trimless fixing system (Optional Kit, p. 30, 32-33). Opal diffuser.



A RICHIESTA | ON REQUEST

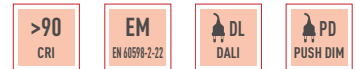

<b>5Y WARRANTY</b> 5% FAILURE RATE	<b>60.000 h</b> LED LIFETIME L90B10	<b>100.000 h</b> LED LIFETIME L70B50
---------------------------------------	--	---

Relamping	Lumen LED*	Watt LED**	Lumen Out***	Watt	Lumen Watt Out	L Lunghezza L Length	Configurazione LED LED configuration	Codice Code	K	Alimentazione Power Supply	Colore Colour
1X36	<b>4100</b>	20	2365	21,5	> 110	760 mm	_____	<b>AGSO2020</b>	W: 3.000	— : CAE A RICHIESTA   ON REQUEST	<b>01:</b> bianco white
1X36	<b>4940</b>	25	2592	26,5	> 98	760 mm	_____	<b>AGSO2029</b>	N: 4.000	DL: DALI PD: PUSH DIM	
1X58	<b>6300</b>	30	3598	32,5	> 110	1135 mm	_____	<b>AGSO2030</b>	W: 3.000	— : CAE A RICHIESTA   ON REQUEST	<b>01:</b> bianco white
1X72	<b>7380</b>	36,5	3838	39	> 98	1135 mm	_____	<b>AGSO2042</b>	N: 4.000	DL: DALI PD: PUSH DIM	
2X36	<b>8400</b>	40	4675	42,5	> 110	1510 mm	_____	<b>AGSO2039</b>	W: 3.000	— : CAE A RICHIESTA   ON REQUEST	<b>01:</b> bianco white
2X36	<b>9880</b>	49	5096	52	> 98	1510 mm	_____	<b>AGSO2057</b>	N: 4.000	DL: DALI PD: PUSH DIM	

<b>CE</b>		<b>&gt;80</b> CRI	<b>IP43</b> EN 60529	<b>230 V</b> 2014/35/UE	<b>50/60</b> Hz	<b>IK 07</b> EN 60068
<b>850°</b> EN 60695	<b>A++</b> A+ A	<b>RG 0</b> EN 62471		<b>01</b> WHITE	<b>SELV</b>	

TEMPERATURA AMBIENTE MIN E MAX | MIN AND MAX ROOM TEMPERATURE: (-10° +40°)

\* Lumen nominali LED max a 25° | Nominal lumen at max 25°

\*\* Potenza dei LED | LED power

\*\*\* Flusso totale in uscita dall'apparecchio a temperatura di lavoro (Ta 25° - 4.000 K) | Total lighting fitting flux output at working temperature (Ta 25° - 4.000 K) | (3.000 K -8% - CRI 90 -10%)



Fotometrie | Photometries  
p. 3



Schema di cablaggio | Connection scheme  
p. XXVIII-XXIX



Descrizione prodotto | Product description  
p. 2



Accessori | Accessories  
p. 21, 30, 32-33

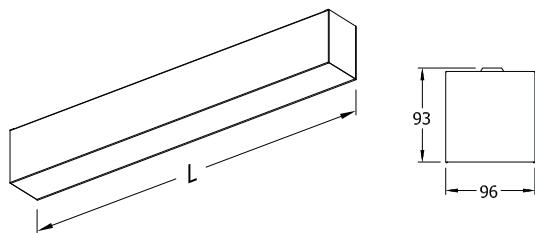

Lunghezze disponibili | Available lengths:  
760 mm - 1135 mm - 1510 mm

# ALGEBRA SYSTEM MP



Apparecchio LED per montaggio in fila continua a plafone. Montaggio a sospensione o ad incasso trimless a richiesta (kit opzionale, p. 30, 32-33). Schermo microprismato. LED lighting fitting for continuous line for ceiling fixing system. On request suspension or recessed trimless fixing system (Optional Kit, p. 30, 32-33). Microprismatic diffuser.

A RICHIESTA | ON REQUEST



**5Y WARRANTY**  
5% FAILURE RATE

**60.000 h**  
LED LIFETIME L90B10

**100.000 h**  
LED LIFETIME L70B50

Relamping	Lumen LED*	Watt LED**	Lumen Out***	Watt	Lumen Watt Out	L Lunghezza L Length	Configurazione LED LED configuration	Codice Code	K	Alimentazione Power Supply	Colore Colour
1X58	<b>4100</b>	20	2800	21,5	> 130	760 mm	_____	<b>AGSMP2020</b>	W: 3.000	— : CAE A RICHIESTA   ON REQUEST	<b>01:</b> bianco white
1X58	<b>4940</b>	25	3153	26,5	> 119	760 mm	_____	<b>AGSMP2029</b>	N: 4.000	DL: DALI PD: PUSH DIM	
2X36	<b>6300</b>	30	4225	32,5	> 130	1135 mm	_____	<b>AGSMP2030</b>	W: 3.000	— : CAE A RICHIESTA   ON REQUEST	<b>01:</b> bianco white
2X36	<b>7360</b>	36,5	4641	39	> 119	1135 mm	_____	<b>AGSMP2042</b>	N: 4.000	DL: DALI PD: PUSH DIM	
2X58	<b>8400</b>	40	5551	42,5	> 130	1510 mm	_____	<b>AGSMP2039</b>	W: 3.000	— : CAE A RICHIESTA   ON REQUEST	<b>01:</b> bianco white
2X58	<b>9880</b>	49	6190	52	> 119	1510 mm	_____	<b>AGSMP2057</b>	N: 4.000	DL: DALI PD: PUSH DIM	

TEMPERATURA AMBIENTE MIN E MAX | MIN AND MAX ROOM TEMPERATURE: (-10° +40°)

\* Lumen nominali LED max a 25° | Nominal lumen at max 25°  
 \*\* Potenza dei LED | LED power  
 \*\*\* Flusso totale in uscita dall'apparecchio a temperatura di lavoro (Ta 25° - 4.000 K) | Total lighting fitting flux output at working temperature (Ta 25° - 4.000 K) | (3.000 K -8% - CRI 90 -10%)

CE

**>80**  
CRI

**IP43**  
EN 60529

**230 V**  
2014/35/UE

**50/60**  
Hz

**IK 07**  
EN 60068

**850°**  
EN 60695

**RG 0**  
EN 62471

**01**  
WHITE

**SELV**

**19**  
UGR

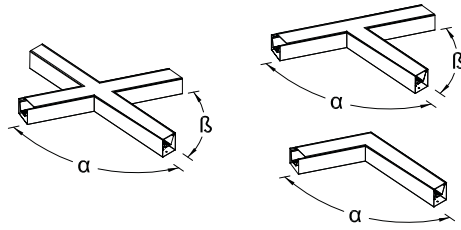

Giunti luminosi tutta-luce con angolazione personalizzata.  
 Codice d'ordine **AGLT20-S** (angoli  $\alpha$  e  $\beta$  a richiesta).  
 Continuous luminous joint with customized angle.  
 Order code **AGLT20-S** (on request angles  $\alpha$  and  $\beta$ ).

# GIUNTI LUMINOSI/LUMINOUS JOINT

## ALGEBRA SYSTEM OP/MP

Apparecchio LED per montaggio in fila continua a plafone. Montaggio a sospensione o ad incasso trimless a richiesta (kit opzionale, p. 30, 32-33). Schermo opale/microprismato.  
 LED lighting fitting for continuous line for ceiling fixing system. On request suspension or recessed trimless fixing system (Optional Kit, p. 30, 32-33). Opal/micropismatic diffuser.



<b>5Y WARRANTY</b> 5% FAILURE RATE	<b>60.000 h</b> LED LIFETIME L90B10	<b>100.000 h</b> LED LIFETIME L70B50
---------------------------------------	--	---

<b>&gt;90</b> CRI	<b>EM</b> EN 60910-2-22	<b>DL</b> DALI	<b>PD</b> PUSH DIM
----------------------	----------------------------	-------------------	-----------------------

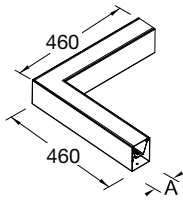

Lumen LED*	Watt LED**	Lumen Out***	Watt	Lumen Watt Out
<b>Giunto luminoso angolare 90°/ L90° luminous joint</b>				
<b>4100</b>	20	2365	21,5	> 110
<b>4940</b>	25	2592	26,5	> 98
Lumen versione OP, per LUMEN MP +16%				
<b>CONFIG. L   A= 96 mm</b>				

Codice Code	K	Schermo Diffuser	Alimentazione Power Supply	Colore Colour
<b>AGLT2020L</b>		<b>OP:</b> Opale/Opal	— : CAE	<b>01:</b> bianco white
<b>AGLT2029L</b>	<b>W:</b> 3.000 <b>N:</b> 4.000	<b>MP:</b> Microprismato Microprismatic	A RICHIESTA   ON REQUEST <b>DL:</b> DALI <b>PD:</b> PUSH DIM	

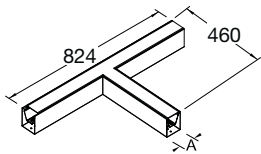

Lumen LED*	Watt LED**	Lumen Out***	Watt	Lumen Watt Out
<b>Giunto luminoso 3 vie/ T luminous joint</b>				
<b>6300</b>	30	3598	32,5	> 110
<b>7380</b>	36,5	3838	39	> 110
Lumen versione OP, per LUMEN MP +16%				
<b>CONFIG. L   A= 96 mm</b>				

Codice Code	K	Schermo Diffuser	Alimentazione Power Supply	Colore Colour
<b>AGLT2030T</b>		<b>OP:</b> Opale/Opal	— : CAE	<b>01:</b> bianco white
<b>AGLT2042T</b>	<b>W:</b> 3.000 <b>N:</b> 4.000	<b>MP:</b> Microprismato Microprismatic	A RICHIESTA   ON REQUEST <b>DL:</b> DALI <b>PD:</b> PUSH DIM	

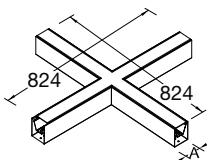

Lumen LED*	Watt LED**	Lumen Out***	Watt	Lumen Watt Out
<b>Giunto luminoso 4 vie/ X luminous joint</b>				
<b>8400</b>	40	4675	42,5	> 110
<b>9880</b>	49	5096	52	> 98
Lumen versione OP, per LUMEN MP +16%				
<b>CONFIG. X   A= 96 mm</b>				

Codice Code	K	Schermo Diffuser	Alimentazione Power Supply	Colore Colour
<b>AGLT2039X</b>		<b>OP:</b> Opale/Opal	— : CAE	<b>01:</b> bianco white
<b>AGLT2057X</b>	<b>W:</b> 3.000 <b>N:</b> 4.000	<b>MP:</b> Microprismato Microprismatic	A RICHIESTA   ON REQUEST <b>DL:</b> DALI <b>PD:</b> PUSH DIM	

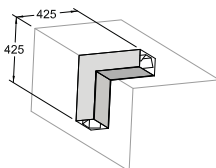

Lumen LED*	Watt LED**	Lumen Out***	Watt	Lumen Watt Out
<b>Giunto luminoso per continuità plafone-parete/ Luminous joint for continuous line ceiling-wall surface</b>				
<b>4100</b>	20	2365	21,5	> 110
<b>4940</b>	25	2592	26,5	> 98
Lumen versione OP, per LUMEN MP +16%				
<b>CONFIG. L   A= 96 mm</b>				

Codice Code	K	Schermo Diffuser	Alimentazione Power Supply	Colore Colour
<b>AGLT2020P</b>		<b>OP:</b> Opale/Opal	— : CAE	<b>01:</b> bianco white
<b>AGLT2029P</b>	<b>W:</b> 3.000 <b>N:</b> 4.000	<b>MP:</b> Microprismato Microprismatic	A RICHIESTA   ON REQUEST <b>DL:</b> DALI <b>PD:</b> PUSH DIM	

<b>CE</b>	<b>&gt;80</b> CRI	<b>IP43</b> EN 60529	<b>230 V</b> 2014/35/UE	<b>50/60</b> Hz	<b>IK 07</b> EN 60068
<b>850°</b> EN 60695	<b>A++</b> A+	<b>RG 0</b> EN 62471	<b>01</b> WHITE	<b>SELV</b>	

TEMPERATURA AMBIENTE MIN E MAX | MIN AND MAX ROOM TEMPERATURE: (-10° +40°)

\* Lumen nominali LED max a 25° | Nominal lumen at max 25°

\*\* Potenza dei LED | LED power

\*\*\* Flusso totale in uscita dall'apparecchio a temperatura di lavoro (Ta 25° - 4.000 K) | Total lighting fitting flux output at working temperature (Ta 25° - 4.000 K) | (3.000 K -8% - CRI 90 -10%)

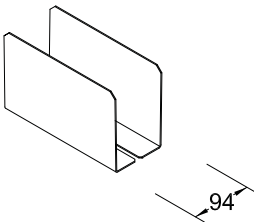
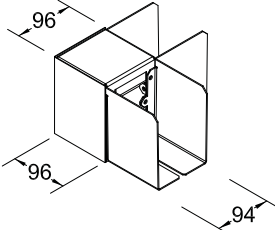
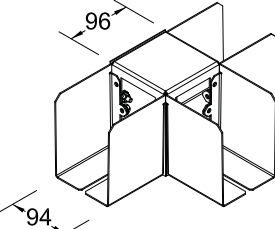
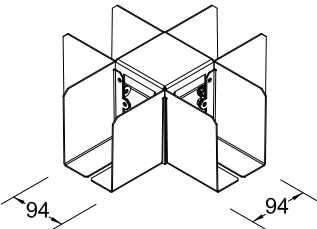
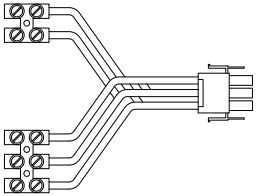
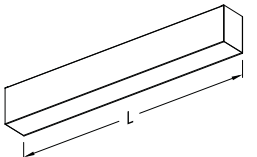
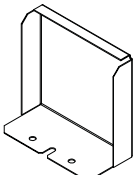
	DESCRIZIONE ACCESSORIO ACCESSORY DESCRIPTION	IDONEO PER: SUITABLE FOR:	CODICE CODE
	<p>Giunto lineare a scomparsa con sospensione centrale in acciaio zincato pressopiegato.</p> <p><i>Hidden linear joint with zinc coated steel central suspension.</i></p>	ALGEBRA SYSTEM	<b>AGL20-G</b>
	<p>Giunto angolare 90° in acciaio pressopiegato verniciato con polveri epossidiche cablaggio standard 5 poli.</p> <p><i>Bent steel L90° joint painted with epoxy powders standard 5-poles wiring.</i></p>	ALGEBRA SYSTEM	<b>GFL20-L</b>
	<p>Giunto angolare 3 vie in acciaio pressopiegato verniciato con polveri epossidiche cablaggio standard 5 poli.</p> <p><i>Bent steel T joint painted with epoxy powders standard 5-poles wiring.</i></p>	ALGEBRA SYSTEM	<b>AGL20-T</b>
	<p>Giunto angolare 4 vie in acciaio pressopiegato verniciato con polveri epossidiche cablaggio standard 5 poli.</p> <p><i>Bent steel X joint painted with epoxy powders standard 5-poles wiring.</i></p>	ALGEBRA SYSTEM	<b>AGL20-X</b>
	<p>Connettore di alimentazione</p> <p><i>Power connector</i></p>	ALGEBRA SYSTEM	<b>AG-A</b>
	<p>Canale cieco/<i>Blind channel</i>   760 mm</p> <p>Canale cieco/<i>Blind channel</i>   1135 mm</p> <p>Canale cieco/<i>Blind channel</i>   1510 mm</p>	ALGEBRA SYSTEM	<b>AGL20760KC</b> <b>AGL201135KC</b> <b>AGL201510KC</b>
	<p>Testata di chiusura</p> <p><i>Endcover</i></p>	ALGEBRA SYSTEM	<b>AGL20-TE</b>

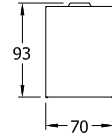
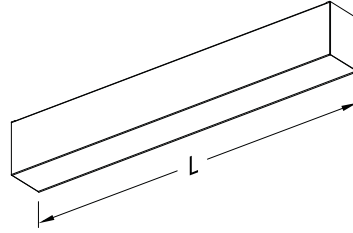

Lunghezze disponibili | Available lengths:  
**760 mm - 1135 mm - 1510 mm**

# ALGEBRA SYSTEM SMALL OP

Apparecchio LED per montaggio in fila continua a plafone. Montaggio a sospensione o ad incasso trimless a richiesta (kit opzionale, p. 30, 32-33). Schermo opale.  
*LED lighting fitting for continuous line for ceiling fixing system. On request suspension or recessed trimless fixing system (Optional Kit, p. 30, 32-33). Opal diffuser.*



**A RICHIESTA | ON REQUEST**

<b>5Y WARRANTY</b> 5% FAILURE RATE	<b>60.000 h</b> LED LIFETIME L90B10	<b>100.000 h</b> LED LIFETIME L70B50
---------------------------------------	--	---

<b>&gt;90</b> CRI	<b>EM</b> EN 60910-2-22	<b>DL</b> DALI	<b>PD</b> PUSH DIM
----------------------	----------------------------	-------------------	-----------------------

Relamping	Lumen LED*	Watt LED**	Lumen Out***	Watt	Lumen Watt Out	L Lunghezza L Length	Configurazione LED LED configuration	Codice Code	K	Alimentazione Power Supply	Colore Colour
1X14	<b>2050</b>	10	1190	11	> 108	760 mm	_____	<b>ASSO2010</b>	W: 3.000	— : CAE A RICHIESTA   ON REQUEST	<b>01:</b> bianco white
1X18	<b>2870</b>	15,5	1580	16,5	> 96	760 mm	_____	<b>ASSO2014</b>	N: 4.000	DL: DALI PD: PUSH DIM	
1X28	<b>3075</b>	15,5	1782	16	> 108	1135 mm	_____	<b>ASSO2015</b>	W: 3.000	— : CAE A RICHIESTA   ON REQUEST	<b>01:</b> bianco white
1X28	<b>4300</b>	23,5	2400	25	> 96	1135 mm	_____	<b>ASSO2021</b>	N: 4.000	DL: DALI PD: PUSH DIM	
1X35	<b>4100</b>	20,5	2376	24	> 108	1510 mm	_____	<b>ASSO2020</b>	W: 3.000	— : CAE A RICHIESTA   ON REQUEST	<b>01:</b> bianco white
1X35	<b>5730</b>	31	3170	33	> 96	1510 mm	_____	<b>ASSO2029</b>	N: 4.000	DL: DALI PD: PUSH DIM	

<b>CE</b>		<b>&gt;80</b> CRI	<b>IP43</b> EN 60529	<b>230 V</b> 2014/35/UE	<b>50/60</b> Hz	<b>IK 07</b> EN 60608
<b>850°</b> EN 60695	<b>A++</b> A+ A	<b>RG 0</b> EN 62471		<b>01</b> WHITE	<b>SELV</b>	

TEMPERATURA AMBIENTE MIN E MAX | MIN AND MAX ROOM TEMPERATURE: **(-10° +40°)**

\* Lumen nominali LED max a 25° | Nominal lumen at max 25°

\*\* Potenza dei LED | LED power

\*\*\* Flusso totale in uscita dall'apparecchio a temperatura di lavoro (Ta 25° - 4.000 K) | Total lighting fitting flux output at working temperature (Ta 25° - 4.000 K) | (3.000 K -8% - CRI 90 -10%)



Fotometrie | Photometries  
p. 5



Schema di cablaggio | Connection scheme  
p. XXVIII-XXIX



Descrizione prodotto | Product description  
p. 4



Accessori | Accessories  
p. 21, 30, 32-33



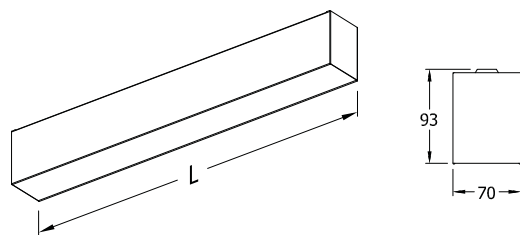

Lunghezze disponibili | Available lengths:  
**760 mm - 1135 mm - 1510 mm**

# ALGEBRA SYSTEM SMALL MP



Apparecchio LED per montaggio in fila continua a plafone. Montaggio a sospensione o ad incasso trimless a richiesta (kit opzionale, p. 30, 32-33). Schermo microprismato. LED lighting fitting for continuous line for ceiling fixing system. On request suspension or recessed trimless fixing system (Optional Kit, p. 30, 32-33). Microprismatic diffuser.

**A RICHIESTA | ON REQUEST**



Relamping	Lumen LED*	Watt LED**	Lumen Out***	Watt	Lumen Watt Out	L Lunghezza L Length	Configurazione LED LED configuration	Codice Code	K	Alimentazione Power Supply	Colore Colour
1X24	<b>2050</b>	10	1354	11	> 123	760 mm	_____	<b>ASSMP2010</b>	W: 3.000	— : CAE A RICHIESTA   ON REQUEST	<b>01:</b> bianco white
1X24	<b>2870</b>	15,5	1895	16,5	> 115	760 mm	_____	<b>ASSMP2014</b>	N: 4.000	DL: DALI PD: PUSH DIM	
1X28	<b>3075</b>	15,5	2030	16,5	> 123	1135 mm	_____	<b>ASSMP2015</b>	W: 3.000	— : CAE A RICHIESTA   ON REQUEST	<b>01:</b> bianco white
1X36	<b>4300</b>	23,5	2875	25	> 115	1135 mm	_____	<b>ASSMP2021</b>	N: 4.000	DL: DALI PD: PUSH DIM	
1X35	<b>4100</b>	20,5	2576	24	> 108	1510 mm	_____	<b>ASSMP2020</b>	W: 3.000	— : CAE A RICHIESTA   ON REQUEST	<b>01:</b> bianco white
1X58	<b>5730</b>	31	3795	33	> 115	1510 mm	_____	<b>ASSMP2029</b>	N: 4.000	DL: DALI PD: PUSH DIM	

TEMPERATURA AMBIENTE MIN E MAX | MIN AND MAX ROOM TEMPERATURE: (-10° +40°)

\* Lumen nominali LED max a 25° | Nominal lumen at max 25°  
 \*\* Potenza dei LED | LED power  
 \*\*\* Flusso totale in uscita dall'apparecchio a temperatura di lavoro (Ta 25° - 4.000 K) | Total lighting fitting flux output at working temperature (Ta 25° - 4.000 K) | (3.000 K -8% - CRI 90 -10%)



Accessori | Accessories  
 p. 21, 30, 32-33



Descrizione prodotto | Product description  
 p. 4



Schema di cablaggio | Connection scheme  
 p. XXVIII-XXIX



Fotometrie | Photometries  
 p. 5

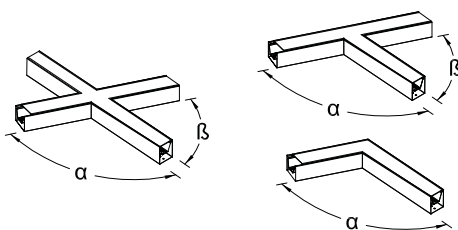

Giunti luminosi tutta-luce con angolazione personalizzata.  
Codice d'ordine **ASST20-S** (angoli  $\alpha$  e  $\beta$  a richiesta).  
Continuous luminous joint with customized angle.  
Order code **ASST20-S** (on request angles  $\alpha$  and  $\beta$ ).

# GIUNTI LUMINOSI/LUMINOUS JOINT

## ALGEBRA SYSTEM SMALL OP/MP

Apparecchio LED per montaggio in fila continua a plafone. Montaggio a sospensione o ad incasso trimless a richiesta (kit opzionale, p. 30, 32-33). Schermo opale/microprismato.  
LED lighting fitting for continuous line for ceiling fixing system. On request suspension or recessed trimless fixing system (Optional Kit, p. 30, 32-33). Opal/micropismatic diffuser.



A RICHIESTA | ON REQUEST

**5Y WARRANTY**  
5% FAILURE RATE

**60.000 h**  
LED LIFETIME L90B10

**100.000 h**  
LED LIFETIME L70B50

>90  
CRI

EM  
EN 60598-2-22

DL  
DALI

PD  
PUSH DIM

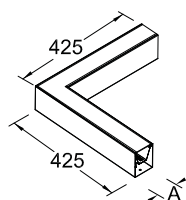

Lumen LED\*    Watt LED\*\*    Lumen Out\*\*\*    Watt    Lumen Watt Out

**Giunto luminoso angolare 90°/ L90° luminous joint**

<b>2050</b>	10	1190	11	> 108
<b>2870</b>	15,5	1580	16,5	> 96

Lumen versione OP, per LUMEN MP +16%  
**CONFIG. L** | **A= 70 mm**

Codice Code	K	Schermo Diffuser	Alimentazione Power Supply	Colore Colour
<b>ASST2010L</b>		<b>OP:</b> Opale/Opal	— : CAE	<b>01:</b> bianco white
<b>ASST2014L</b>	<b>W:</b> 3.000 <b>N:</b> 4.000	<b>MP:</b> Microprismato Microprismatic	A RICHIESTA   ON REQUEST <b>DL:</b> DALI <b>PD:</b> PUSH DIM	

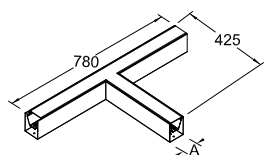

**Giunto luminoso 3 vie/ T luminous joint**

<b>3075</b>	15,5	1782	16,5	> 108
<b>4300</b>	23,5	2400	25	> 96

Lumen versione OP, per LUMEN MP +16%  
**CONFIG. L** | **A= 70 mm**

Codice Code	K	Schermo Diffuser	Alimentazione Power Supply	Colore Colour
<b>ASST2015T</b>		<b>OP:</b> Opale/Opal	— : CAE	<b>01:</b> bianco white
<b>ASST2021T</b>	<b>W:</b> 3.000 <b>N:</b> 4.000	<b>MP:</b> Microprismato Microprismatic	A RICHIESTA   ON REQUEST <b>DL:</b> DALI <b>PD:</b> PUSH DIM	

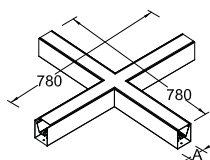

**Giunto luminoso 4 vie/ X luminous joint**

<b>4100</b>	20,5	2376	24	> 108
<b>5730</b>	31	3170	33	> 96

Lumen versione OP, per LUMEN MP +16%  
**CONFIG. X** | **A= 70 mm**

Codice Code	K	Schermo Diffuser	Alimentazione Power Supply	Colore Colour
<b>ASST2020X</b>		<b>OP:</b> Opale/Opal	— : CAE	<b>01:</b> bianco white
<b>ASST2029X</b>	<b>W:</b> 3.000 <b>N:</b> 4.000	<b>MP:</b> Microprismato Microprismatic	A RICHIESTA   ON REQUEST <b>DL:</b> DALI <b>PD:</b> PUSH DIM	

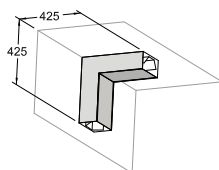

**Giunto luminoso per continuità plafone-parete/ Luminous joint for continuous line ceiling-wall surface**

<b>2050</b>	10	1190	11	> 108
<b>2870</b>	15,5	1580	16,5	> 96

Lumen versione OP, per LUMEN MP +16%  
**CONFIG. L** | **A= 70 mm**

Codice Code	K	Schermo Diffuser	Alimentazione Power Supply	Colore Colour
<b>ASST2010P</b>		<b>OP:</b> Opale/Opal	— : CAE	<b>01:</b> bianco white
<b>ASST2014P</b>	<b>W:</b> 3.000 <b>N:</b> 4.000	<b>MP:</b> Microprismato Microprismatic	A RICHIESTA   ON REQUEST <b>DL:</b> DALI <b>PD:</b> PUSH DIM	

		>80 CRI	IP43 EN 60529	230 V 2014/35/UE	50/60 Hz	IK 07 EN 60068
850° EN 60695		RG 0 EN 62471		01 WHITE	SELV	

TEMPERATURA AMBIENTE MIN E MAX | MIN AND MAX ROOM TEMPERATURE: (-10° +40°)

\* Lumen nominali LED max a 25° | Nominal lumen at max 25°

\*\* Potenza dei LED | LED power

\*\*\* Flusso totale in uscita dall'apparecchio a temperatura di lavoro (Ta 25° - 4.000 K) | Total lighting fitting flux output at working temperature (Ta 25° - 4.000 K) | (3.000 K -8% - CRI 90 -10%)



	DESCRIZIONE ACCESSORIO ACCESSORY DESCRIPTION	IDONEO PER: SUITABLE FOR:	CODICE CODE
	<p>Giunto lineare a scomparsa con sospensione centrale in acciaio zincato pressopiegato.</p> <p><i>Hidden linear joint with zinc coated steel central suspension.</i></p>	ALGEBRA SYSTEM SMALL	<b>ASS20-G</b>
	<p>Giunto angolare 90° in acciaio pressopiegato verniciato con polveri epossidiche cablaggio standard 5 poli.</p> <p><i>Bent steel L90° joint painted with epoxy powders standard 5-poles wiring.</i></p>	ALGEBRA SYSTEM SMALL	<b>ASS20-L</b>
	<p>Giunto angolare 3 vie in acciaio pressopiegato verniciato con polveri epossidiche cablaggio standard 5 poli.</p> <p><i>Bent steel T joint painted with epoxy powders standard 5-poles wiring.</i></p>	ALGEBRA SYSTEM SMALL	<b>ASS20-T</b>
	<p>Giunto angolare 4 vie in acciaio pressopiegato verniciato con polveri epossidiche cablaggio standard 5 poli.</p> <p><i>Bent steel X joint painted with epoxy powders standard 5-poles wiring.</i></p>	ALGEBRA SYSTEM SMALL	<b>ASS20-X</b>
	<p>Connettore di alimentazione</p> <p><i>Power connector</i></p>	ALGEBRA SYSTEM SMALL	<b>AG-A</b>
	<p>Canale cieco/<i>Blind channel</i>   760 mm          Canale cieco/<i>Blind channel</i>   1135 mm          Canale cieco/<i>Blind channel</i>   1510 mm</p>	ALGEBRA SYSTEM SMALL	<b>ASS20760KC</b> <b>ASS201135KC</b> <b>ASS201510KC</b>
	<p>Testata di chiusura</p> <p><i>Endcover</i></p>	ALGEBRA SYSTEM SMALL	<b>ASS20-TE</b>

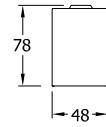
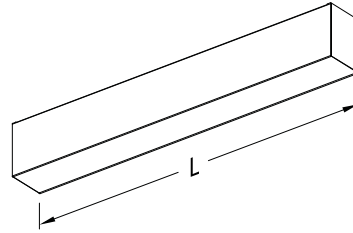

Lunghezze disponibili | Available lengths:  
**760 mm - 1135 mm - 1510 mm**

# ALGEBRA SYSTEM MICRO OP

Apparecchio LED per montaggio in fila continua a plafone. Montaggio a sospensione o ad incasso trimless a richiesta (kit opzionale, p. 30, 32-33). Schermo opale.  
LED lighting fitting for continuous line for ceiling fixing system. On request suspension or recessed trimless fixing system (Optional Kit, p. 30, 32-33). Opal diffuser.



**A RICHIESTA | ON REQUEST**

<b>5Y WARRANTY</b> 5% FAILURE RATE	<b>60.000 h</b> LED LIFETIME L90B10	<b>100.000 h</b> LED LIFETIME L70B50
---------------------------------------	--	---

<b>&gt;90</b> CRI	<b>EM</b> EN 60910-2-22	<b>DL</b> DALI	<b>PD</b> PUSH DIM
----------------------	----------------------------	-------------------	-----------------------

Relamping	Lumen LED*	Watt LED**	Lumen Out***	Watt	Lumen Watt Out	L Lunghezza L Length	Configurazione LED LED configuration	Codice Code	K	Alimentazione Power Supply	Colore Colour
1X18	<b>2050</b>	10	1190	11	> 108	760 mm	_____	<b>AMSO2010</b>	W: 3.000	— : CAE A RICHIESTA   ON REQUEST	<b>01:</b> bianco white
1X18	<b>2870</b>	15,5	1580	16,5	> 96	760 mm	_____	<b>AMSO2014</b>	N: 4.000	<b>DL:</b> DALI <b>PD:</b> PUSH DIM	
1X24	<b>3075</b>	15,5	1732	16,5	> 108	1135 mm	_____	<b>AMSO2015</b>	W: 3.000	— : CAE A RICHIESTA   ON REQUEST	<b>01:</b> bianco white
1X24	<b>4300</b>	23,5	2400	25	> 96	1135 mm	_____	<b>AMSO2021</b>	N: 4.000	<b>DL:</b> DALI <b>PD:</b> PUSH DIM	
1X35	<b>4100</b>	20,5	2376	24	> 108	1510 mm	_____	<b>AMSO2020</b>	W: 3.000	— : CAE A RICHIESTA   ON REQUEST	<b>01:</b> bianco white
1X35	<b>5730</b>	31	3170	33	> 96	1510 mm	_____	<b>AMSO2029</b>	N: 4.000	<b>DL:</b> DALI <b>PD:</b> PUSH DIM	

<b>CE</b>		<b>&gt;80</b> CRI	<b>IP43</b> EN 60529	<b>230 V</b> 2014/35/UE	<b>50/60</b> Hz	<b>IK 07</b> EN 60068
<b>850°</b> EN 60695	<b>A++</b> A+ A	<b>RG 0</b> EN 62471		<b>01</b> WHITE	<b>SELV</b>	

TEMPERATURA AMBIENTE MIN E MAX | MIN AND MAX ROOM TEMPERATURE: **(-10° +40°)**

\* Lumen nominali LED max a 25° | Nominal lumen at max 25°

\*\* Potenza dei LED | LED power

\*\*\* Flusso totale in uscita dall'apparecchio a temperatura di lavoro (Ta 25° - 4.000 K) | Total lighting fitting flux output at working temperature (Ta 25° - 4.000 K) | (3.000 K -8% - CRI 90 -10%)

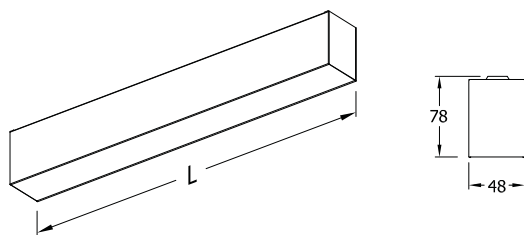

Lunghezze disponibili | Available lengths:  
**760 mm - 1135 mm - 1510 mm**

# ALGEBRA SYSTEM MICRO MP



Apparecchio LED per montaggio in fila continua a plafone. Montaggio a sospensione o ad incasso trimless a richiesta (kit opzionale, p. 30, 32-33). Schermo microprismato. LED lighting fitting for continuous line for ceiling fixing system. On request suspension or recessed trimless fixing system (Optional Kit, p. 30, 32-33). Microprismatic diffuser.

**A RICHIESTA | ON REQUEST**



Relamping	Lumen LED*	Watt LED**	Lumen Out***	Watt	Lumen Watt Out	L Lunghezza L Length	Configurazione LED LED configuration	Codice Code	K	Alimentazione Power Supply	Colore Colour
1X24	<b>2050</b>	10	1354	11	> 123	760 mm	_____	<b>AMSMP2010</b>	W: 3.000	— : CAE A RICHIESTA   ON REQUEST	<b>01:</b> bianco white
1X24	<b>2870</b>	15,5	1895	16,5	> 115	760 mm	_____	<b>AMSMP2014</b>	N: 4.000	DL: DALI PD: PUSH DIM	
1X28	<b>3075</b>	15,5	2030	16,5	> 123	1135 mm	_____	<b>AMSMP2015</b>	W: 3.000	— : CAE A RICHIESTA   ON REQUEST	<b>01:</b> bianco white
1X36	<b>4300</b>	23,5	2875	25	> 115	1135 mm	_____	<b>AMSMP2021</b>	N: 4.000	DL: DALI PD: PUSH DIM	
1X35	<b>4100</b>	20,5	2576	24	> 108	1510 mm	_____	<b>AMSMP2020</b>	W: 3.000	— : CAE A RICHIESTA   ON REQUEST	<b>01:</b> bianco white
1X35	<b>5730</b>	31	3795	33	> 115	1510 mm	_____	<b>AMSMP2029</b>	N: 4.000	DL: DALI PD: PUSH DIM	

TEMPERATURA AMBIENTE MIN E MAX | MIN AND MAX ROOM TEMPERATURE: (-10° +40°)

\* Lumen nominali LED max a 25° | Nominal lumen at max 25°  
 \*\* Potenza dei LED | LED power  
 \*\*\* Flusso totale in uscita dall'apparecchio a temperatura di lavoro (Ta 25° - 4.000 K) | Total lighting fitting flux output at working temperature (Ta 25° - 4.000 K) | (3.000 K -8% - CRI 90 -10%)



Accessori | Accessories  
 p. 29, 30, 32-33



Descrizione prodotto | Product description  
 p. 6



Schema di cablaggio | Connection scheme  
 p. XXVIII-XXIX



Fotometrie | Photometries  
 p. 7

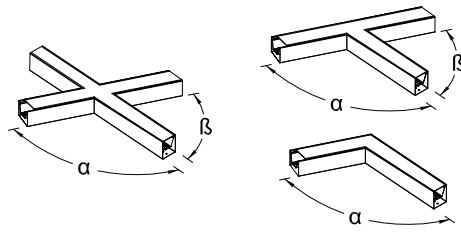
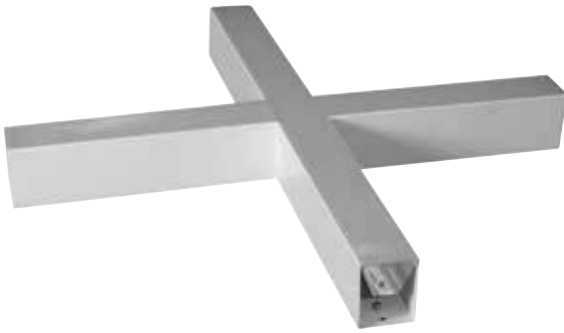

Giunti luminosi tutta-luce con angolazione personalizzata. Codice d'ordine **AMST20-S** (angoli  $\alpha$  e  $\beta$  a richiesta). Continuous luminous joint with customized angle. Order code **AMST20-S** (on request angles  $\alpha$  and  $\beta$ ).

# GIUNTI LUMINOSI/LUMINOUS JOINT

## ALGEBRA SYSTEM MICRO OP/MP

Apparecchio LED per montaggio in fila continua a plafone. Montaggio a sospensione o ad incasso trimless a richiesta (kit opzionale, p. 30, 32-33). Schermo opale/microprismato. LED lighting fitting for continuous line for ceiling fixing system. On request suspension or recessed trimless fixing system (Optional Kit, p. 30, 32-33). Opal/micropismatic diffuser.



A RICHIESTA | ON REQUEST

<b>5Y WARRANTY</b> 5% FAILURE RATE	<b>60.000 h</b> LED LIFETIME L90B10	<b>100.000 h</b> LED LIFETIME L70B50
---------------------------------------	--	---

>90 CRI	EM EN 60910-2-22	DL DALI	PD PUSH DIM
------------	---------------------	------------	----------------

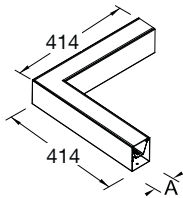

Lumen LED*	Watt LED**	Lumen Out***	Watt	Lumen Watt Out
<b>Giunto luminoso angolare 90°/ L90° luminous joint</b>				
2050	10	1190	11	> 108
2870	15,5	1580	16,5	> 96
Lumen versione OP, per LUMEN MP +16%				
<b>CONFIG. L   A= 48 mm</b>				

Codice Code	K	Schermo Diffuser	Alimentazione Power Supply	Colore Colour
<b>AMST2010L</b>		<b>OP:</b> Opale/Opal	— : CAE	<b>01:</b> bianco white
<b>AMST2014L</b>	<b>W:</b> 3.000 <b>N:</b> 4.000	<b>MP:</b> Microprismato Microprismatic	A RICHIESTA   ON REQUEST <b>DL:</b> DALI <b>PD:</b> PUSH DIM	

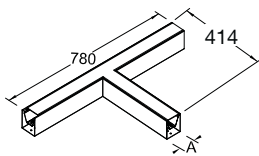

Lumen LED*	Watt LED**	Lumen Out***	Watt	Lumen Watt Out
<b>Giunto luminoso 3 vie/ T luminous joint</b>				
3075	15,5	1782	16,5	> 108
4300	23,5	2400	25	> 96
Lumen versione OP, per LUMEN MP +16%				
<b>CONFIG. L   A= 48 mm</b>				

Codice Code	K	Schermo Diffuser	Alimentazione Power Supply	Colore Colour
<b>AMST2015T</b>		<b>OP:</b> Opale/Opal	— : CAE	<b>01:</b> bianco white
<b>AMST2021T</b>	<b>W:</b> 3.000 <b>N:</b> 4.000	<b>MP:</b> Microprismato Microprismatic	A RICHIESTA   ON REQUEST <b>DL:</b> DALI <b>PD:</b> PUSH DIM	

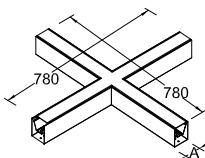

Lumen LED*	Watt LED**	Lumen Out***	Watt	Lumen Watt Out
<b>Giunto luminoso 4 vie/ X luminous joint</b>				
4100	20,5	2376	24	> 108
5730	31	3170	33	> 96
Lumen versione OP, per LUMEN MP +16%				
<b>CONFIG. X   A= 48 mm</b>				

Codice Code	K	Schermo Diffuser	Alimentazione Power Supply	Colore Colour
<b>AMST2020X</b>		<b>OP:</b> Opale/Opal	— : CAE	<b>01:</b> bianco white
<b>AMST2029X</b>	<b>W:</b> 3.000 <b>N:</b> 4.000	<b>MP:</b> Microprismato Microprismatic	A RICHIESTA   ON REQUEST <b>DL:</b> DALI <b>PD:</b> PUSH DIM	

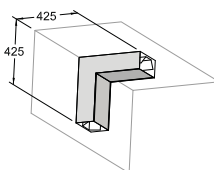

Lumen LED*	Watt LED**	Lumen Out***	Watt	Lumen Watt Out
<b>Giunto luminoso per continuità plafone-parete/ Luminous joint for continuous line ceiling-wall surface</b>				
2050	10	1190	11	> 108
2870	15,5	1580	16,5	> 96
Lumen versione OP, per LUMEN MP +16%				
<b>CONFIG. L   A= 48 mm</b>				

Codice Code	K	Schermo Diffuser	Alimentazione Power Supply	Colore Colour
<b>AMST2010P</b>		<b>OP:</b> Opale/Opal	— : CAE	<b>01:</b> bianco white
<b>AMST2014P</b>	<b>W:</b> 3.000 <b>N:</b> 4.000	<b>MP:</b> Microprismato Microprismatic	A RICHIESTA   ON REQUEST <b>DL:</b> DALI <b>PD:</b> PUSH DIM	

CE		>80 CRI	IP43 EN 60529	230 V 2014/35/UE	50/60 Hz	IK 07 EN 60068
850° EN 60695	A++ A+ A	RG 0 EN 62471		01 WHITE	SELV	

TEMPERATURA AMBIENTE MIN E MAX | MIN AND MAX ROOM TEMPERATURE: (-10° +40°)

\* Lumen nominali LED max a 25° | Nominal lumen at max 25°

\*\* Potenza dei LED | LED power

\*\*\* Flusso totale in uscita dall'apparecchio a temperatura di lavoro (Ta 25° - 4.000 K) | Total lighting fitting flux output at working temperature (Ta 25° - 4.000 K) | (3.000 K -8% - CRI 90 -10%)

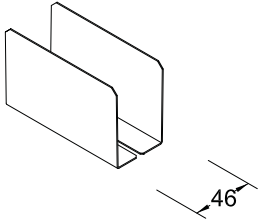
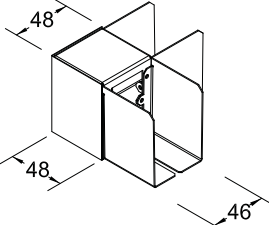
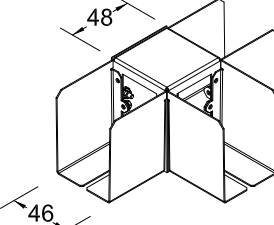
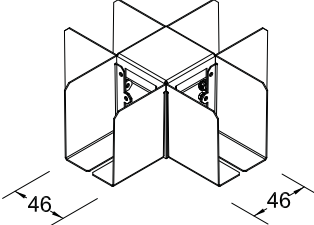
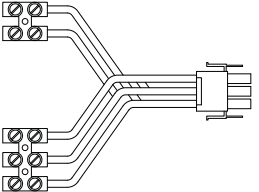
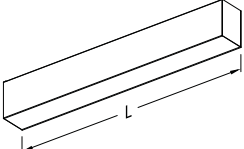
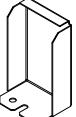

	DESCRIZIONE ACCESSORIO ACCESSORY DESCRIPTION	IDONEO PER: SUITABLE FOR:	CODICE CODE
	<p>Giunto lineare a scomparsa con sospensione centrale in acciaio zincato pressopiegato.</p> <p><i>Hidden linear joint with zinc coated steel central suspension.</i></p>	ALGEBRA SYSTEM MICRO	<b>AMS20-G</b>
	<p>Giunto angolare 90° in acciaio pressopiegato verniciato con polveri epossidiche cablaggio standard 5 poli.</p> <p><i>Bent steel L90° joint painted with epoxy powders standard 5-poles wiring.</i></p>	ALGEBRA SYSTEM MICRO	<b>AMS20-L</b>
	<p>Giunto angolare 3 vie in acciaio pressopiegato verniciato con polveri epossidiche cablaggio standard 5 poli.</p> <p><i>Bent steel T joint painted with epoxy powders standard 5-poles wiring.</i></p>	ALGEBRA SYSTEM MICRO	<b>AMS20-T</b>
	<p>Giunto angolare 4 vie in acciaio pressopiegato verniciato con polveri epossidiche cablaggio standard 5 poli.</p> <p><i>Bent steel X joint painted with epoxy powders standard 5-poles wiring.</i></p>	ALGEBRA SYSTEM MICRO	<b>AMS20-X</b>
	<p>Connettore di alimentazione</p> <p><i>Power connector</i></p>	ALGEBRA SYSTEM MICRO	<b>AG-A</b>
	<p>Canale cieco/<i>Blind channel</i>   760 mm</p> <p>Canale cieco/<i>Blind channel</i>   1135 mm</p> <p>Canale cieco/<i>Blind channel</i>   1510 mm</p>	ALGEBRA SYSTEM MICRO	<b>AMS20760KC</b> <b>AMS201135KC</b> <b>AMS201510KC</b>
	<p>testata di chiusura</p> <p><i>Endcover</i></p>	ALGEBRA SYSTEM MICRO	<b>AMS20-TE</b>

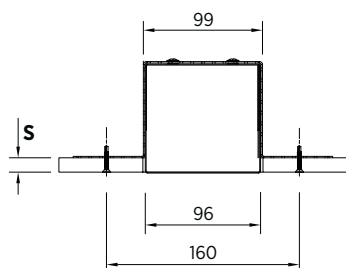
DESCRIZIONE ACCESSORIO  
ACCESSORY DESCRIPTIONIDONEO PER:  
SUITABLE FOR:CODICE  
CODE

Staffa per installazione trimless.  
Spessore controsoffitto (**S**) da definire.

*Bracket for trimless installation.  
False ceiling thickness (**S**) to be defined.*

ALGEBRA  
ALGEBRA SYSTEM

AGS-TR

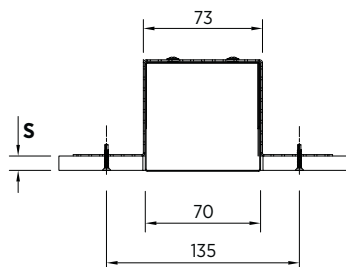

Staffa per installazione trimless.  
Spessore controsoffitto (**S**) da definire.

*Bracket for trimless installation.  
False ceiling thickness (**S**) to be defined.*

ALGEBRA SMALL  
ALGEBRA SYSTEM SMALL

ASS-TR

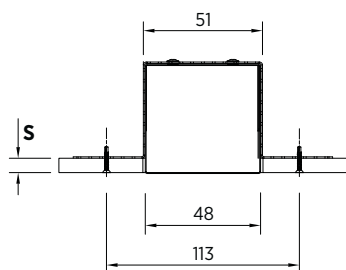

Staffa per installazione trimless.  
Spessore controsoffitto (**S**) da definire.

*Bracket for trimless installation.  
False ceiling thickness (**S**) to be defined.*

ALGEBRA MICRO  
ALGEBRA SYSTEM MICRO

AMS-TR

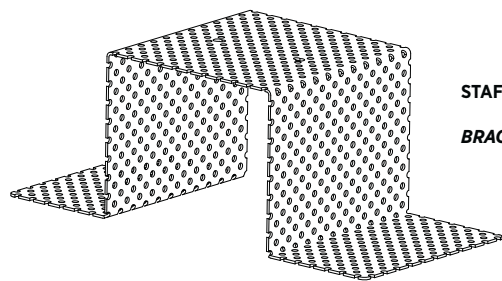

STAFFA PER INSTALLAZIONE TRIMLESS

BRACKET FOR TRIMLESS INSTALLATION

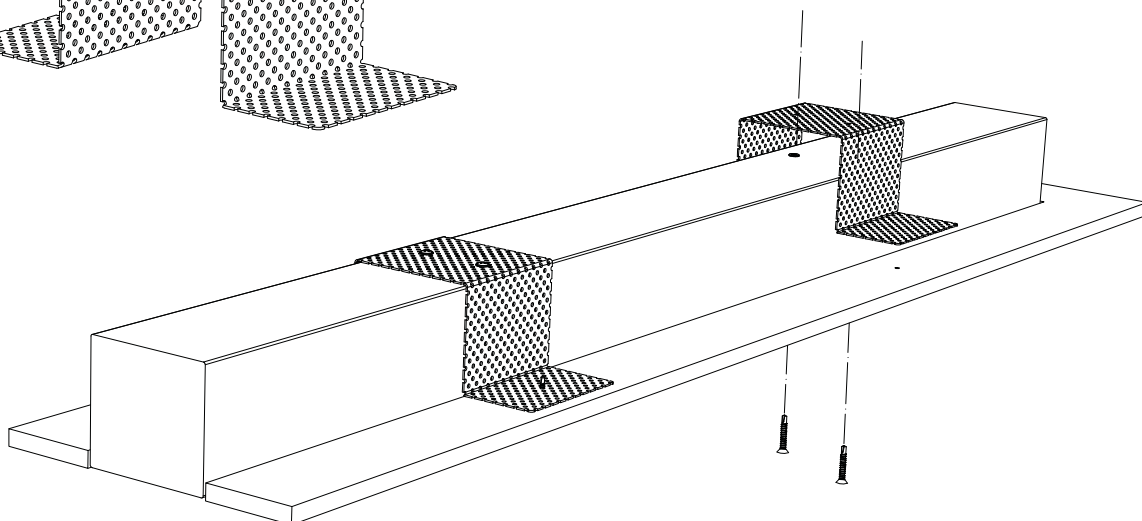

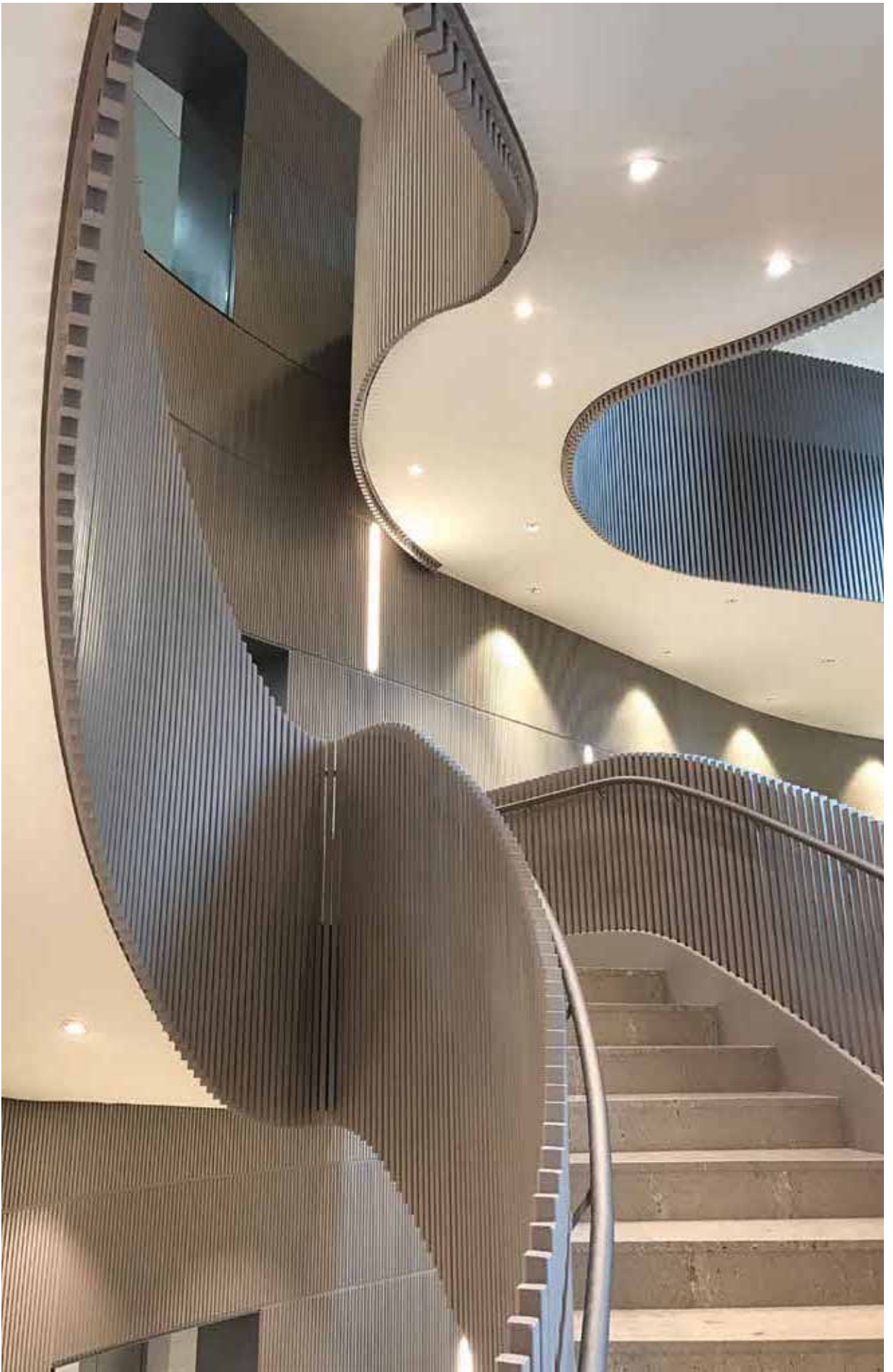



DESCRIZIONE ACCESSORIO  
ACCESSORY DESCRIPTION

IDONEO PER:  
SUITABLE FOR:

CODICE  
CODE

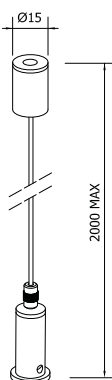

Kit sospensione:  
**n. 1 cavo d'acciaio** L=2000 mm  
n. 1 perno regolazione millimetrica  
n. 1 rosone cilindrico

GAMMA ALGEBRA

KT 10410

*Suspension kit: **no. 1 steel cable**  
L=2000 mm - no. 1 precision  
adjustment pin - n. 1 cylindrical  
ceiling rose*

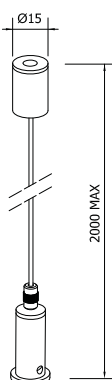

Kit sospensione:  
**n. 2 cavi d'acciaio** L=2000 mm  
n. 2 perni regolazione millimetrica  
n. 2 rosconi cilindrici

GAMMA ALGEBRA  
BB TECK

KT 10420

*Suspension kit:  
**no. 2 steel cables** L=2000 mm  
no. 2 precision adjustment pins  
no. 2 cylindrical ceiling roses*

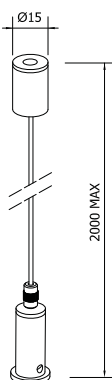

Kit sospensione:  
**n. 4 cavi d'acciaio** L=2000 mm  
n. 4 perni regolazione millimetrica  
n. 4 rosconi cilindrici

FLOATING LED  
FLAT LINE LED DARK  
BB LED  
BB LUCE LED  
FLAT SMASH  
RELAX LED  
RELAX LED R  
RELAX LED SPA  
RELAX LED SPA R

KT 10440

*Suspension kit:  
**no. 4 steel cables** L=2000 mm  
no. 4 precision adjustment pins  
no. 4 cylindrical ceiling roses*

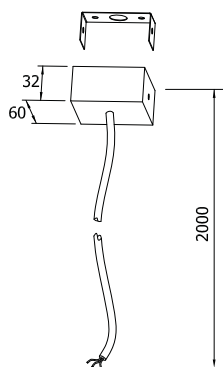

Kit rosone elettrificato completo  
di cavo trasparente L=2000 mm  
**3x0,75 mm<sup>2</sup>, per soluzioni CAE**

APPARECCHI A SOSPENSIONE  
SUSPENSION LIGHTING  
FIXTURES

KT10206

*Electrified ceiling rose complete  
with transparent cable L=2000 mm  
**3x0,75 mm<sup>2</sup>, for CAE version***

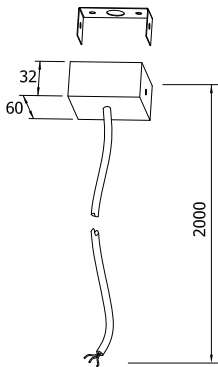
DESCRIZIONE ACCESSORIO  
ACCESSORY DESCRIPTIONIDONEO PER:  
SUITABLE FOR:CODICE  
CODE

Kit rosone elettrificato completo  
di cavo trasparente L=2000 mm  
**5x0,75 mm<sup>2</sup>, per soluzioni EM/DL**

*Electrified ceiling rose complete  
with transparent cable L=2000 mm  
**5x0,75 mm<sup>2</sup>, for EM/DL version***

APPARECCHI A SOSPENSIONE  
*SUSPENSION LIGHTING  
FIXTURES*

KT10206/D

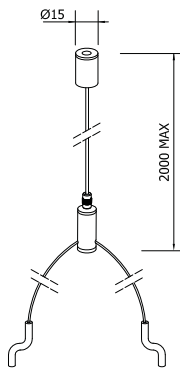

Kit sospensione:  
**n. 2 cavi d'acciaio** L=2000 mm  
n. 2 cilindri di bilanciamento con  
cavo doppio  
n. 2 rosone cilindrici

*Suspension kit:  
**no. 2 steel cables** L=2000 mm  
no. 2 balancing cylinder with  
double cable  
no. 2 cylindrical ceiling roses*

FLOATING LED  
FLAT LINE LED DARK  
BB LED  
BB LUCE LED  
RELAX LED R  
RELAX LED SPA R

KT10441

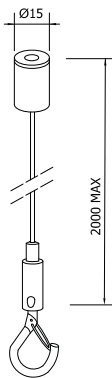

Kit sospensione:  
**n. 1 cavo d'acciaio** L=2000 mm  
n. 1 morsetto automatico con  
regolazione millimetrica  
n. 1 rosone cilindrico

*Suspension kit:  
**no. 1 steel cables** L=2000 mm  
no. 1 precision adjustment  
automatic hook  
no. 1 cylindrical ceiling rose*

BINGO  
BINGO SYSTEM LED  
BINLENS SYSTEM

KT10411





Performance  
illuminotecniche  
nettamente superiori  
all'attuale generazione  
di lampade a LED.

*Lighting performance  
definitely higher compared  
to the others LED fixtures  
in the market nowadays.*



## **SOSPENSIONE • SUSPENSION | PLAFONE • CEILING PARETE • WALL**

**Sistema di apparecchi illuminotecnici LED per il settore industriale e terziario.**  
LED lighting fixtures system for industries and services.





# GAMMA PRODOTTI | PRODUCT RANGE

**SOSPENSIONE • SUSPENSION | PLAFONE • CEILING**  
**PARETE • WALL**



## FLOATING LED

p. 40-41

Corpo in lamiera di acciaio pressopiegato, verniciata con polveri epossidiche previa fosfatazione. Telaio in alluminio estruso verniciato. Ottica microprismata a bassa luminanza idonea per ambienti con videotermini (inferiore a 1000cd/m<sup>2</sup> per angoli > 65°). Sistema di fissaggio a sospensione (prevista installazione a plafone per versione a luce diretta). Sorgente luminosa LED. Emissione diretta o emissione diretta-indiretta. Non idonea per l'applicazione esterna. Alimentazione elettronica CAE. A richiesta: dimmerabile DALI (cod. DL) specificare se con funzione PUSH DIM (cod. PD).

*Bent steel sheet body painted with epoxy powders after phosphating. Painted extruded aluminium frame. Low UGR optic suitable in rooms with VDT (lower than 1000 cd/m<sup>2</sup> for angles >65°). Suspension fixing system (ceiling fixing system for the direct light emission version). LED light source. Direct and direct/indirect light emission. Not suitable for outdoor application. Built in electronic driver CAE. On request: dimmable DALI (code DL) PUSH DIM function (code PD) to be requested.*



## FLAT LINE LED DARK

p. 42-43

Corpo in lamiera di acciaio pressopiegato, verniciata con polveri epossidiche previa fosfatazione. Telaio in estruso in alluminio verniciato. Ottica lamellare in alluminio ad alto rendimento con microprismato a bassa luminanza idonea per ambienti con videotermini (inferiore a 1000cd/m<sup>2</sup> per angoli > 65°). Sistema di fissaggio a sospensione (prevista installazione a plafone per versione a luce diretta). Sorgente luminosa LED. Emissione diretta o emissione diretta-indiretta. Non idonea per l'applicazione esterna. Alimentazione elettronica CAE. A richiesta: dimmerabile DALI (cod. DL) specificare se con funzione PUSH DIM (cod. PD).

*Bent steel sheet body painted with epoxy powders after phosphating. Painted extruded aluminium frame. High performance lamellar aluminium optic with low UGR microprismatic diffuser suitable in rooms with VDT (lower than 1000 cd/m<sup>2</sup> for angles >65°). Suspension fixing system (ceiling fixing system for the direct light emission version). LED light source. Direct and direct/indirect light emission. Not suitable for outdoor application. Built in electronic driver CAE. On request: dimmable DALI (code DL) PUSH DIM function (code PD) to be requested.*



## RELAX LED SPA

p. 44-45

Corpo e telaio in lamiera di acciaio pressopiegato con spigoli arrotondati, verniciata con polveri epossidiche previa fosfatazione. Ottica dark a bassa luminanza idonea per ambienti con videotermini (inferiore a 1000 cd/m<sup>2</sup> per angoli superiori a 65° trasversali e longitudinali). Sistema di fissaggio a plafone o, a richiesta, a sospensione. Sorgente luminosa LED. Emissione diretta. Non idonea per l'applicazione esterna. Alimentazione elettronica CAE. A richiesta: dimmerabile DALI (cod. DL) specificare se con funzione PUSH DIM (cod. PD).

*Bent steel sheet body and frame with rounded edges painted with epoxy powders after phosphating. Low UGR optic suitable in rooms with VDT (lower than 1000 cd/m<sup>2</sup> for angles >65° transversal and longitudinal). Ceiling fixing system or, on request, suspension fixing system. LED light source. Direct light emission. Not suitable for outdoor application. Built in electronic driver CAE. On request: dimmable DALI (code DL) PUSH DIM function (code PD) to be requested.*



## RELAX LED

p. 46-47

Corpo e telaio in lamiera di acciaio pressopiegato con spigoli arrotondati, verniciata con polveri epossidiche previa fosfatazione. Schermo in policarbonato microprismato (a richiesta opale cod. OP) a bassa luminanza idonea in ambienti con videotermini (inferiori a 1000 cd/m<sup>2</sup> per angoli superiori a 65° trasversali e longitudinali). Sistema di fissaggio a plafone o, a richiesta, a sospensione. Sorgente luminosa LED. Emissione diretta. Non idonea per l'applicazione esterna. Alimentazione elettronica CAE. A richiesta: dimmerabile DALI (cod. DL) specificare se con funzione PUSH DIM (cod. PD).

*Bent steel sheet body and frame with rounded edges painted with epoxy powders after phosphating. Low UGR microprismatic polycarbonate diffuser (on request: opal code OP) suitable in rooms with VDT (lower than 1000 cd/m<sup>2</sup> for angles >65° transversal and longitudinal). Ceiling fixing system or, on request, suspension fixing system. LED light source. Direct light emission. Not suitable for outdoor application. Built in electronic driver CAE. On request: dimmable DALI (code DL) PUSH DIM function (code PD) to be requested.*



## BB TECK

p. 48

Corpo e testata in lamiera d'acciaio pressopiegata, verniciata con polveri epossidiche previa fosfatazione. Ottica microprismata a bassa luminanza idonea in ambienti con videotermini (inferiore a 1000 cd/m<sup>2</sup> per angoli superiori a 65° trasversali e longitudinali). Sistema di fissaggio a plafone. Sorgente luminosa LED. Emissione diretta. Non idonea per l'applicazione esterna. Alimentazione elettronica CAE. A richiesta: dimmerabile DALI (cod. DL) specificare se con funzione PUSH DIM (cod. PD).

*Bent steel sheet body and endcover painted with epoxy powders after phosphating. Low UGR microprismatic polycarbonate diffuser suitable in rooms with VDT (lower than 1000 cd/m<sup>2</sup> for angles >65° transversal and longitudinal). Ceiling fixing system. LED light source. Direct light emission. Not suitable for outdoor application. Built in electronic driver CAE. On request: dimmable DALI (code DL) PUSH DIM function (code PD) to be requested.*

# FOTOMETRIE | PHOTOMETRIES

SOSPENSIONE • SUSPENSION | PLAFONE • CEILING  
PARETE • WALL

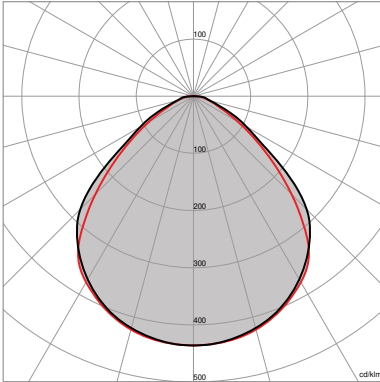

**FLOOTING LED-DIR**

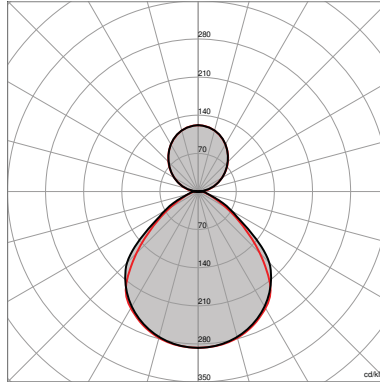

**FLOOTING LED-DIR/IND**

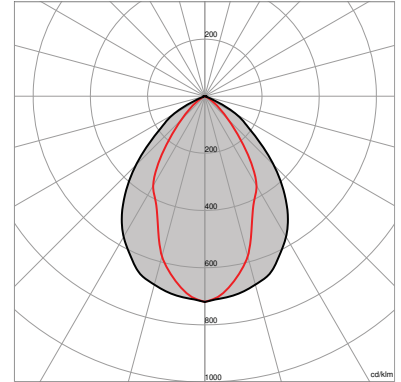

**FLAT LINE LED DARK-DIR**

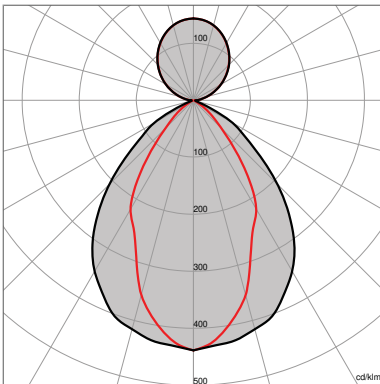

**FLAT LINE LED DARK-DIR/IND**

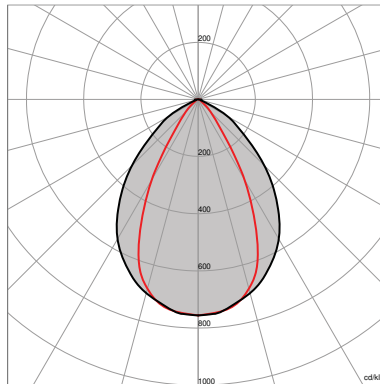

**RELAX LED SPA**

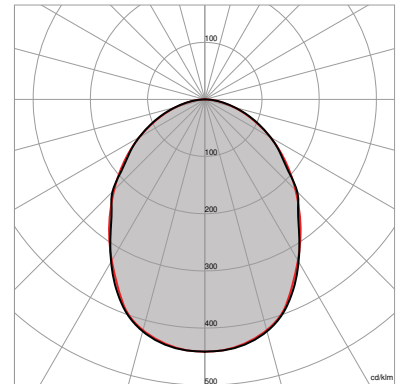

**RELAX LED**

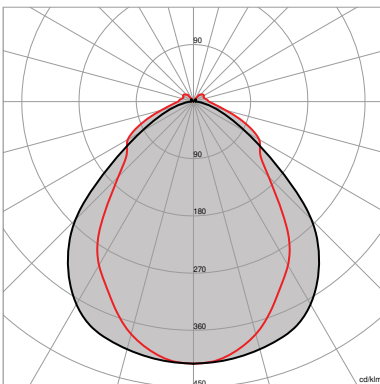

**BB TECK**



Rimani aggiornato  
Keep up to date

# GAMMA PRODOTTI | PRODUCT RANGE

**SOSPENSIONE • SUSPENSION | PLAFONE • CEILING**  
**PARETE • WALL**



## BB LED

p. 49

Corpo e testata in lamiera d'acciaio pressopiegata, verniciata con polveri epossidiche previa fosfatazione. Schermo in policarbonato estruso rigato opale. Sistema di fissaggio a plafone. Sorgente luminosa LED. Emissione diretta. Non idonea per l'applicazione esterna. Alimentazione elettronica CAE. A richiesta: dimmerabile DALI (cod. DL) specificare se con funzione PUSH DIM (cod. PD).

*Bent steel sheet body and endcover painted with epoxy powders after phosphating. Opal ribbed extruded polycarbonate diffuser. Ceiling fixing system. LED light source. Direct light emission. Not suitable for outdoor application. Built in electronic driver CAE. On request: dimmable DALI (code DL) PUSH DIM function (code PD) to be requested.*



## FLAT SMASH

p. 50

Fondo in lamiera di acciaio verniciato con polveri epossidiche previa fosfatazione. Corpo in estruso di alluminio. Schermo in policarbonato opale, a richiesta schermo microprismato (cod. MP). Sistema di fissaggio a plafone/parete. Sorgente luminosa LED. Emissione diretta. Non idonea per l'applicazione esterna. Alimentazione elettronica CAE.

*Bent steel sheet bottom painted with epoxy powders after phosphating. Extruded aluminium body. Opal polycarbonate diffuser, on request microprismatic polycarbonate diffuser (cod. MP). Ceiling and wall fixing system. LED light source. Direct light emission. Not suitable for outdoor application. Built in electronic driver CAE.*



## GARDENA LED

p. 51

Base portacablaggio e telaio in ABS. Diffusore in metacrilato termoformato. Installazione a plafone/parete. Sorgente luminosa LED. Emissione diretta. Alimentazione CAE.

*White ABS Gear plate and frame. Thermoformed methacrylate diffuser. Ceiling and wall fixing system. LED light source. Direct light emission. Built in electronic driver CAE.*

# FOTOMETRIE | PHOTOMETRIES

SOSPENSIONE • SUSPENSION | PLAFONE • CEILING  
PARETE • WALL

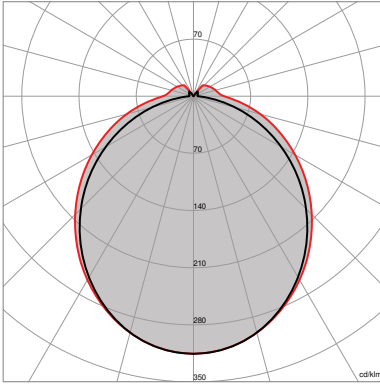

BB LED

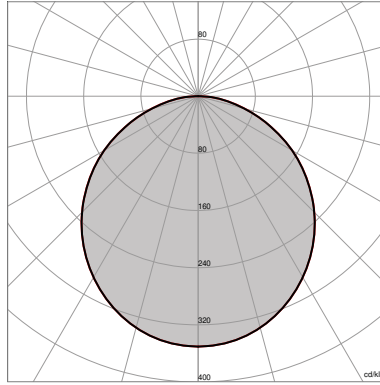

FLAT SMASH

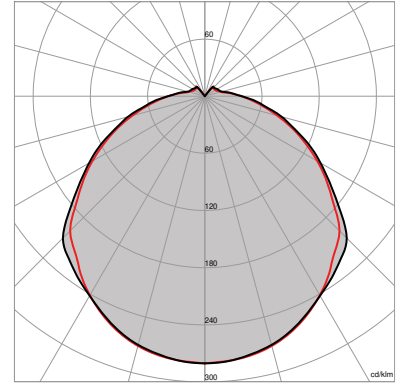

GARDENA LED



Rimani aggiornato  
Keep up to date

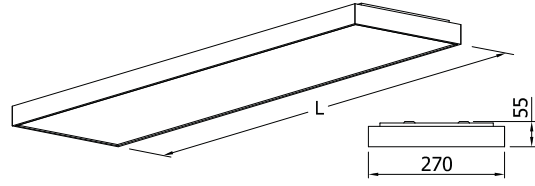

# FLOORING LED

## Emissione diretta/Direct emission

Apparecchio decorativo LED a bassa luminanza.  
LED decorative lighting fitting, low luminance.

Lunghezze disponibili | Available lengths:  
**1156 mm - 1530 mm**

**5Y WARRANTY**  
5% FAILURE RATE

**60.000 h**  
LED LIFETIME L90B10

**100.000 h**  
LED LIFETIME L70B50



A RICHIESTA | ON REQUEST

**>90**  
CRI

**EM**  
EN 60910-2-22

**DL**  
DALI

**PD**  
PUSH DIM

Relamping	Lumen LED*	Watt LED**	Lumen Out***	Watt	Lumen Watt Out	L Lunghezza L Length	Configurazione LED LED configuration	Codice Code	K	Alimentazione Power Supply	Colore Colour
2x28	<b>6150</b>	30	4060	32	> 126	1156 mm	=====	<b>FFD33</b>		W: 3.000 N: 4.000 — : CAE A RICHIESTA   ON REQUEST <b>DL:</b> DALI <b>PD:</b> PUSH DIM	<b>01:</b> bianco white  <b>05:</b> grigio silver
2x36	<b>7900</b>	41	5220	43,5	> 120	1156 mm	=====	<b>FFD43</b>			
2x36	<b>8600</b>	47	5680	50	> 114	1156 mm	=====	<b>FFD48</b>			
2x35	<b>8200</b>	41	5485	43,5	> 126	1530 mm	=====	<b>FFD44</b>			
2x58	<b>10500</b>	54,5	6960	58	> 120	1530 mm	=====	<b>FFD58</b>			
2x58	<b>11500</b>	62,5	6580	66,5	> 114	1530 mm	=====	<b>FFD64</b>			

**>80**  
CRI

**IP40**  
EN 60529

**230 V**  
2014/35/UE

**50/60**  
Hz

**IK 07**  
EN 60068

**850°**  
EN 60695

**RG 0**  
EN 62471

**01**  
WHITE

**05**  
SILVER

**SELV**

**19**  
UGR

TEMPERATURA AMBIENTE MIN E MAX | MIN AND MAX ROOM TEMPERATURE: **(-10° +40°)**

\* Lumen nominali LED max a 25° | Nominal lumen at max 25°

\*\* Potenza dei LED | LED power

\*\*\* Flusso totale in uscita dall'apparecchio a temperatura di lavoro (Ta 25° - 4.000 K) | Total lighting fitting flux output at working temperature (Ta 25° - 4.000 K) | (3.000 K -8% - CRI 90 -10%)

**KT10440**

KIT Sospensione (4 cavi d'acciaio L 2000 mm, n. 4 perni a regolazione millimetrica e n. 4 rosoni cilindrici) a richiesta. | Suspension KIT (no. 4 steel cables L 2000 mm, no. 4 precision adjustment pins and no. 4 cylindrical ceiling roses) on request.

**KT10441**

KIT Sospensione bifido (2 cavi d'acciaio L 2000 mm, n. 2 cilindri di bilanciamento con cavo doppio e n. 2 rosoni cilindrici) a richiesta. | Split suspension KIT (no. 2 steel cables L 2000 mm, no. 2 balancing cylinder with double cable and no. 2 cylindrical ceiling roses) on request.



Fotometrie | Photometries  
p. 37



Schema di cablaggio | Connection scheme  
p. XXVIII-XXIX



Descrizione prodotto | Product description  
p. 36



Accessori | Accessories  
p. 52-53

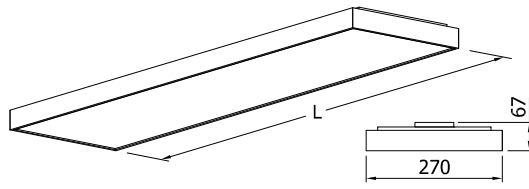

Lunghezze disponibili | Available lengths:  
1156 mm - 1530 mm

# FLOORING LED

## Emissione diretta-indiretta/Direct-indirect emission

Apparecchio decorativo LED a bassa luminanza con doppia accensione.  
LED decorative lighting fitting, low luminance with double switch.



A RICHIESTA | ON REQUEST

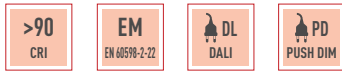

Relamping	Lumen LED* Diretta/Direct	Lumen LED* Indiretta/Indirect	Watt LED**	Lumen Out***	Watt	Lumen Watt Out	L Lunghezza L Length	Configurazione LED LED configuration	Codice Code	K	Alimentazione Power Supply	Colore Colour
2x28	<b>6150</b>	<b>2915</b>	32 + 16	3925+ 1962	35+ 17	> 115	1156 mm	≡≡≡ + ≡≡≡	<b>FFI33</b>		W: 3.000  N: 4.000  — : CAE A RICHIESTA   ON REQUEST DL: DALI PD: PUSH DIM	<b>01:</b> bian- co white  <b>05:</b> grigio silver
2x36	<b>7900</b>	<b>3890</b>	40,5 + 20	5237+ 2618	43+ 21	> 124	1156 mm	≡≡≡ + ≡≡≡	<b>FFI43</b>			
2x36	<b>8600</b>	<b>3960</b>	48 + 24	5332+ 2666	51+ 25,5	> 104	1156 mm	≡≡≡ + ≡≡≡	<b>FFI48</b>			
2x35	<b>8200</b>	<b>4000</b>	44 + 22	5385+ 2962	47+ 23,5	> 126	1530 mm	≡≡≡ + ≡≡≡	<b>FFI44</b>			
2x58	<b>10500</b>	<b>4840</b>	54 + 27	6516+ 3258	58+ 29	> 112	1530 mm	≡≡≡ + ≡≡≡	<b>FFI58</b>			
2x58	<b>11500</b>	<b>5280</b>	64 + 32	7109+ 3554	68+ 34	> 104	1530 mm	≡≡≡ + ≡≡≡	<b>FFI64</b>			

TEMPERATURA AMBIENTE MIN E MAX | MIN AND MAX ROOM TEMPERATURE: (-10° +40°)

\* Lumen nominali LED max a 25° | Nominal lumen at max 25°  
 \*\* Potenza dei LED | LED power  
 \*\*\* Flusso totale in uscita dall'apparecchio a temperatura di lavoro (Ta 25° - 4.000 K) | Total lighting fitting flux output at working temperature (Ta 25° - 4.000 K) | (3.000 K -8% - CRI 90 -10%)

**INCLUSO | INCLUDED**  
 KIT Sospensione (4 cavi d'acciaio L 2000 mm, n. 4 perni a regolazione millimetrica e n. 4 rosoni cilindrici). | Suspension KIT (no. 4 steel cables L 2000 mm, no. 4 precision adjustment pins and no. 4 cylindrical ceiling roses).

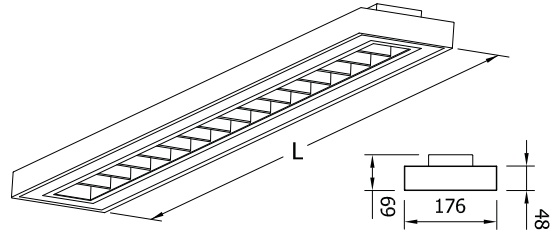

# FLAT LINE LED DARK

## Emissione diretta/Direct emission

Apparecchio decorativo LED a bassa luminanza.  
LED decorative lighting fitting, low luminance.

Lunghezze disponibili | Available lengths:  
1223 mm - 1598 mm



A RICHIESTA | ON REQUEST

<b>5Y WARRANTY</b> 5% FAILURE RATE	<b>60.000 h</b> LED LIFETIME L90B10	<b>100.000 h</b> LED LIFETIME L70B50
---------------------------------------	--	---

>90 CRI	EM EN 60910-2-22	DL DALI	PD PUSH DIM
------------	---------------------	------------	----------------

Relamping	Lumen LED*	Watt LED**	Lumen Out***	Watt	Lumen Watt Out	L Lunghezza L Length	Configurazione LED LED configuration	Codice Code	K	Alimentazione Power Supply	Colore Colour
2x36	<b>7980</b>	42	5150	44	> 117	1223 mm	=====	<b>FLL43D</b>	<b>W:</b> 3.000	— : CAE A RICHIESTA   ON RE- QUEST	<b>01:</b> bianco white
2x58	<b>10640</b>	56	6900	59	> 117	1598 mm	=====	<b>FLL57D</b>	<b>N:</b> 4.000	<b>DL:</b> DALI <b>PD:</b> PUSH DIM	<b>05:</b> grigio silver

CE	⊕	>80 CRI	IP40 EN 60529	230 V 2014/35/UE	50/60 Hz	IK 07 EN 60068
850° EN 60695	A++ A+	RG 0 EN 62471	01 WHITE	05 SILVER	SELV	
16 UGR						

TEMPERATURA AMBIENTE MIN E MAX | MIN AND MAX ROOM TEMPERATURE: (-10° +40°)

\* Lumen nominali LED max a 25° | Nominal lumen at max 25°

\*\* Potenza dei LED | LED power

\*\*\* Flusso totale in uscita dall'apparecchio a temperatura di lavoro (Ta 25° - 4.000 K) | Total lighting fitting flux output at working temperature (Ta 25° - 4.000 K) | (3.000 K -8% - CRI 90 -10%)

### KT10440

KIT Sospensione (4 cavi d'acciaio L 2000 mm, n. 4 perni a regolazione millimetrica e n. 4 rosoni cilindrici) a richiesta. | Suspension KIT (no. 4 steel cables L 2000 mm, no. 4 precision adjustment pins and no. 4 cylindrical ceiling roses) on request.

### KT10441

KIT Sospensione bifido (2 cavi d'acciaio L 2000 mm, n. 2 cilindri di bilanciamento con cavo doppio e n. 2 rosoni cilindrici) a richiesta. | Split suspension KIT (no. 4 steel cables L 2000 mm, no. 2 balancing cylinder with double cable and no. 2 cylindrical ceiling roses) on request.

### KT102015

Giunto con rosone per fila continua. | Joint with ceiling rose for continuous line application.



Fotometrie | Photometries  
p. 37



Schema di cablaggio | Connection scheme  
p. XXVIII-XXIX



Descrizione prodotto | Product description  
p. 36



Accessori | Accessories  
p. 52-53



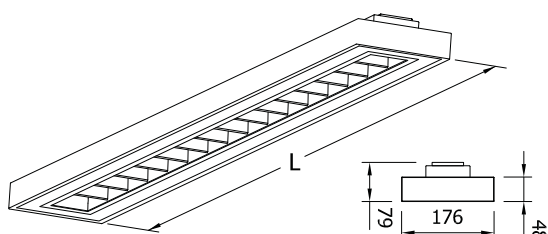

Lunghezze disponibili | Available lengths:  
1223 mm - 1598 mm

# FLAT LINE LED DARK

## Emissione diretta-indiretta/Direct-indirect emission

Apparecchio decorativo LED a bassa luminanza con doppia accensione.  
LED decorative lighting fitting, low luminance with double switch.



A RICHIESTA | ON REQUEST

>90  
CRI

EM  
EN 60598-2-22

DL  
DALI

PD  
PUSH DIM

**5Y WARRANTY**  
5% FAILURE RATE

**60.000 h**  
LED LIFETIME L90B10

**100.000 h**  
LED LIFETIME L70B50

Relamping	Lumen LED* Diretta/Direct	Lumen LED* Indiretta/Indirect	Watt LED**	Lumen Out***	Watt	Lumen Watt Out	L Lunghezza L Length	Conf. LED LED conf.	Codice Code	K	Alimentazione Power Supply	Colore Colour
2x36	<b>7780</b>	<b>3890</b>	40,5 + 20	5237 + 2618	43 + 21	> 124	1223 mm	== + ==	<b>FLL43DI</b>	W: 3.000	— : CAE  A RICHIESTA   ON REQUEST DL: DALI PD: PUSH DIM	<b>01:</b> bianco white
2x58	<b>9680</b>	<b>4840</b>	54 + 27	6516 + 3258	58 + 29	> 112	1598 mm	== + ==	<b>FLL57DI</b>	N: 4.000		<b>05:</b> grigio silver

TEMPERATURA AMBIENTE MIN E MAX | MIN AND MAX ROOM TEMPERATURE: (-10° +40°)

\* Lumen nominali LED max a 25° | Nominal lumen at max 25°

\*\* Potenza dei LED | LED power

\*\*\* Flusso totale in uscita dall'apparecchio a temperatura di lavoro (Ta 25° - 4.000 K) | Total lighting fitting flux output at working temperature (Ta 25° - 4.000 K) | (3.000 K -8% - CRI 90 -10%)

KIT Sospensione (4 cavi d'acciaio L 2000 mm, n. 4 perni a regolazione millimetrica e n. 4 rosoni cilindrici) a richiesta. | Suspension KIT (no. 4 steel cables L 2000 mm, no. 4 precision adjustment pins and no. 4 cylindrical ceiling roses) on request.

**KT102015**

Giunto con rosoni per fila continua. | Joint with ceiling rose for continuous line application.

>80  
CRI

IP40  
EN 60529

230 V  
2014/35/UE

50/60  
Hz

IK 07  
EN 60068

850°  
EN 60695

A++  
A+  
A

RG 0  
EN 62471

01  
WHITE

05  
SILVER

SELV

16  
UGR



Accessori | Accessories  
p. 52-53



Descrizione prodotto | Product description  
p. 36



Schema di cablaggio | Connection scheme  
p. XXVIII-XXIX



Fotometrie | Photometries  
p. 37

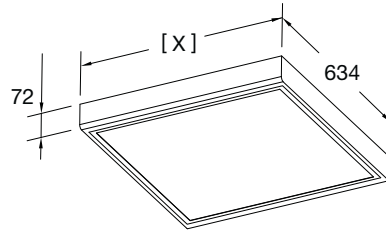

# RELAX LED SPA

Apparecchio professionale LED a bassa luminanza.  
LED professional lighting fitting, low luminance.

[X] Dimensioni disponibili | Available dimensions:  
600x634 mm - 1160x634 mm



A RICHIESTA | ON REQUEST

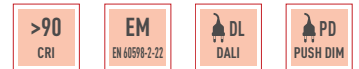

<b>5Y WARRANTY</b> 5% FAILURE RATE	<b>60.000 h</b> LED LIFETIME L90B10	<b>100.000 h</b> LED LIFETIME L70B50
---------------------------------------	--	---

Relamping	Lumen LED*	Watt LED**	Lumen Out***	Watt	Lumen Watt Out	Configurazione LED LED configuration	Codice Code	K	Alimentazione Power Supply	Colore Colour
<b>[X] Dimensioni/Dimensions - 600x634 mm</b>										
4x14	<b>5160</b>	31	3555	33	> 108	=====	<b>RXSA34</b>	W: 3.000 N: 4.000	— : CAE A RICHIESTA   ON REQUEST DL: DALI PD: PUSH DIM	<b>01:</b> bianco white
4x18	<b>6240</b>	36	4120	38,5	> 107	=====	<b>RXSA40</b>			
4x24	<b>7200</b>	41	4650	44	> 106	=====	<b>RXSA56</b>			
<b>[X] Dimensioni/Dimensions - 1160x634 mm</b>										
4x28	<b>13500</b>	68,5	9187	73,5	> 125	=====	<b>RXSA08</b>	W: 3.000 N: 4.000	— : CAE A RICHIESTA   ON REQUEST DL: DALI PD: PUSH DIM	<b>01:</b> bianco white
4x54	<b>15800</b>	82	10560	88	> 120	=====	<b>RXSA12</b>			

CE	⊕	>80 CRI	IP40 EN 60529	230 V 2014/35/UE	50/60 Hz	IK 07 EN 60068
850° EN 60695	A++ A+ A	RG 0 EN 62471	01 WHITE	SELV	16 UGR	

TEMPERATURA AMBIENTE MIN E MAX | MIN AND MAX ROOM TEMPERATURE: (-10° +40°)

\* Lumen nominali LED max a 25° | Nominal lumen at max 25°

\*\* Potenza dei LED | LED power

\*\*\* Flusso totale in uscita dall'apparecchio a temperatura di lavoro (Ta 25° - 4.000 K) | Total lighting fitting flux output at working temperature (Ta 25° - 4.000 K) | (3.000 K -8% - CRI 90 -10%)

**KT10440**

KIT Sospensione (4 cavi d'acciaio L 2000 mm, n. 4 perni a regolazione millimetrica e n. 4 rosoni cilindrici) a richiesta. | Suspension KIT (no. 4 steel cables L 2000 mm, no. 4 precision adjustment pins and no. 4 cylindrical ceiling roses) on request.

**KT10441**

KIT Sospensione bifido (2 cavi d'acciaio L 2000 mm, n. 2 cilindri di bilanciamento con cavo doppio e n. 2 rosoni cilindrici) a richiesta. | Split suspension KIT (no. 4 steel cables L 2000 mm, no. 2 balancing cylinder with double cable and no. 2 cylindrical ceiling roses) on request.



Fotometrie | Photometries  
p. 37



Schema di cablaggio | Connection scheme  
p. XXVIII-XXIX



Descrizione prodotto | Product description  
p. 36



Accessori | Accessories  
p. 52-53

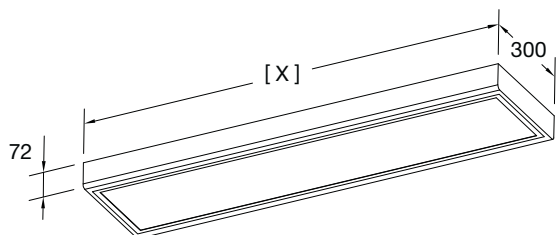

# RELAX LED SPA R

Apparecchio professionale LED a bassa luminanza.  
LED professional lighting fitting, low luminance.

**[X]** Dimensioni disponibili | Available dimensions:  
**1160x300 mm - 1530x300 mm**



**A RICHIESTA | ON REQUEST**



**5Y WARRANTY**  
5% FAILURE RATE

**60.000 h**  
LED LIFETIME L90B10

**100.000 h**  
LED LIFETIME L70B50

Relamping	Lumen LED*	Watt LED**	Lumen Out***	Watt	Lumen Watt Out	Configurazione LED LED configuration	Codice Code	K	Alimentazione Power Supply	Colore Colour
<b>[X]</b> Dimensioni/Dimensions - 1160x300 mm										
2x36	<b>6750</b>	34	4520	37	> 122	=====	<b>RXSAR40</b>	<b>W:</b> 3.000	— : CAE  A RICHIESTA   ON REQUEST	<b>01:</b> bianco white
2x36	<b>7900</b>	41	5250	44	> 119	=====	<b>RXSAR56</b>	<b>N:</b> 4.000	<b>DL:</b> DALI <b>PD:</b> PUSH DIM	
<b>[X]</b> Dimensioni/Dimensions - 1530x300 mm										
2x58	<b>9000</b>	46	5985	49	> 122	=====	<b>RXSAR03</b>	<b>W:</b> 3.000	— : CAE  A RICHIESTA   ON REQUEST	<b>01:</b> bianco white
2x58	<b>10500</b>	54,5	6960	58,5	> 119	=====	<b>RXSAR06</b>	<b>N:</b> 4.000	<b>DL:</b> DALI <b>PD:</b> PUSH DIM	

TEMPERATURA AMBIENTE MIN E MAX | MIN AND MAX ROOM TEMPERATURE: **(-10° +40°)**

\* Lumen nominali LED max a 25° | Nominal lumen at max 25°

\*\* Potenza dei LED | LED power

\*\*\* Flusso totale in uscita dall'apparecchio a temperatura di lavoro (Ta 25° - 4.000 K) | Total lighting fitting flux output at working temperature (Ta 25° - 4.000 K) | (3.000 K -8% - CRI 90 -10%)

#### KT10440

KIT Sospensione (4 cavi d'acciaio L 2000 mm, n. 4 perni a regolazione millimetrica e n. 4 rosoni cilindrici) a richiesta. | Suspension KIT (no. 4 steel cables L 2000 mm, no. 4 precision adjustment pins and no. 4 cylindrical ceiling roses) on request.

#### KT10441

KIT Sospensione bifido (2 cavi d'acciaio L 2000 mm, n. 2 cilindri di bilanciamento con cavo doppio e n. 2 rosoni cilindrici) a richiesta. | Split suspension KIT (no. 4 steel cables L 2000 mm, no. 2 balancing cylinder with double cable and no. 2 cylindrical ceiling roses) on request.



Accessori | Accessories  
p. 52-53



Descrizione prodotto | Product description  
p. 36



Schema di cablaggio | Connection scheme  
p. XXVIII-XXIX



Fotometrie | Photometries  
p. 37

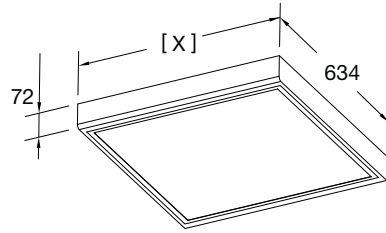

# RELAX LED

Apparecchio professionale LED a bassa luminanza.  
LED professional lighting fitting, low luminance.

[X] Dimensioni disponibili | Available dimensions:  
600x634 mm - 1160x634 mm



A RICHIESTA | ON REQUEST

**5Y WARRANTY**  
5% FAILURE RATE

**60.000 h**  
LED LIFETIME L90B10

**100.000 h**  
LED LIFETIME L70B50

>90  
CRI

EM  
EN 60910-2-22

DL  
DALI

PD  
PUSH DIM

Relamping	Lumen LED*	Watt LED**	Lumen Out***	Watt	Lumen Watt Out	Configurazione LED LED configuration	Codice Code	K	Alimentazione Power Supply	Schermo Diffuser	Colore Colour
<b>[X] Dimensioni/Dimensions - 600x634 mm</b>											
4x14	<b>5160</b>	31	3950	33	> 120	=====	<b>RX34</b>	<b>W:</b> 3.000 <b>N:</b> 4.000	- : CAE A RICHIESTA   ON REQUEST <b>DL:</b> DALI <b>PD:</b> PUSH DIM	<div style="border: 1px solid black; padding: 2px; display: inline-block;">19 UGR</div> - : Microprismato Microprismatic <b>OP:</b> Opale/Opal	<b>01:</b> bianco white
4x18	<b>6240</b>	36	4440	38,5	> 115	=====	<b>RX40</b>				
4x24	<b>7200</b>	41	5020	44	> 114	=====	<b>RX56</b>				
<b>[X] Dimensioni/Dimensions - 1160x634 mm</b>											
4x28	<b>13500</b>	68,5	9456	73,5	> 129	=====	<b>RX08</b>	<b>W:</b> 3.000 <b>N:</b> 4.000	- : CAE A RICHIESTA   ON REQUEST <b>DL:</b> DALI <b>PD:</b> PUSH DIM	<div style="border: 1px solid black; padding: 2px; display: inline-block;">19 UGR</div> - : Microprismato Microprismatic <b>OP:</b> Opale/Opal	<b>01:</b> bianco white
4x54	<b>15800</b>	82	11060	88	> 125	=====	<b>RX12</b>				

CE

>80  
CRI

IP40  
EN 60529

230 V  
2014/35/UE

50/60  
Hz

IK 07  
EN 60068

850°  
EN 60695

A++  
A

RG 0  
EN 62471

01  
WHITE

SELV

TEMPERATURA AMBIENTE MIN E MAX | MIN AND MAX ROOM TEMPERATURE: (-10° +40°)

\* Lumen nominali LED max a 25° | Nominal lumen at max 25°

\*\* Potenza dei LED | LED power

\*\*\* Flusso totale in uscita dall'apparecchio a temperatura di lavoro (Ta 25° - 4.000 K) | Total lighting fitting flux output at working temperature (Ta 25° - 4.000 K) | (3.000 K -8% - CRI 90 -10%)

**KT10440**

KIT Sospensione (4 cavi d'acciaio L 2000 mm, n. 4 perni a regolazione millimetrica e n. 4 rosoni cilindrici) a richiesta. | Suspension KIT (no. 4 steel cables L 2000 mm, no. 4 precision adjustment pins and no. 4 cylindrical ceiling roses) on request.

**KT10441**

KIT Sospensione bifido (2 cavi d'acciaio L 2000 mm, n. 2 cilindri di bilanciamento con cavo doppio e n. 2 rosoni cilindrici) a richiesta. | Split suspension KIT (no. 4 steel cables L 2000 mm, no. 2 balancing cylinder with double cable and no. 2 cylindrical ceiling roses) on request.



Fotometrie | Photometries  
p. 37



Schema di cablaggio | Connection scheme  
p. XXVIII-XXIX



Descrizione prodotto | Product description  
p. 36



Accessori | Accessories  
p. 52-53

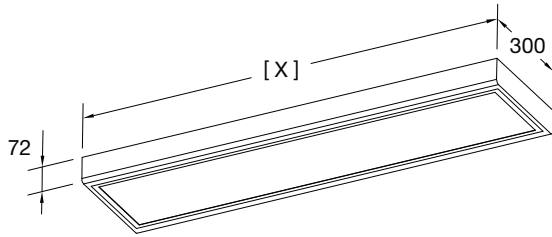

# RELAX LED R

Apparecchio professionale LED a bassa luminanza.  
LED professional lighting fitting, low luminance.

**[X]** Dimensioni disponibili | Available dimensions:  
**1160x300 mm - 1530x300 mm**



**A RICHIESTA | ON REQUEST**



**5Y WARRANTY**  
5% FAILURE RATE

**60.000 h**  
LED LIFETIME L90B10

**100.000 h**  
LED LIFETIME L70B50

Relamping	Lumen LED*	Watt LED**	Lumen Out***	Watt	Lumen Watt Out	Configurazione LED LED configuration	Codice Code	K	Alimentazione Power Supply	Schermo Diffuser	Colore Colour
<b>[X]</b> Dimensioni/Dimensions - 1160x300 mm											
2x36	<b>6750</b>	34	4810	37	> 130	=====	<b>RXR40</b>	<b>W:</b> 3.000	— : CAE A RICHIESTA   ON REQUEST	<b>19</b> UGR Microprismatico Microprismatic	<b>01:</b> bianco white
2x36	<b>7900</b>	41	5590	44	> 127	=====	<b>RXR56</b>	<b>N:</b> 4.000	<b>DL:</b> DALI <b>PD:</b> PUSH DIM	<b>OP:</b> Opale/Opal	
<b>[X]</b> Dimensioni/Dimensions - 1530x300 mm											
2x58	<b>9000</b>	46	6370	49	> 130	=====	<b>RXR03</b>	<b>W:</b> 3.000	— : CAE A RICHIESTA   ON REQUEST	<b>19</b> UGR Microprismatico Microprismatic	<b>01:</b> bianco white
2x58	<b>10500</b>	54,5	7430	58,5	> 127	=====	<b>RXR06</b>	<b>N:</b> 4.000	<b>DL:</b> DALI <b>PD:</b> PUSH DIM	<b>OP:</b> Opale/Opal	

TEMPERATURA AMBIENTE MIN E MAX | MIN AND MAX ROOM TEMPERATURE: (-10° +40°)

\* Lumen nominali LED max a 25° | Nominal lumen at max 25°

\*\* Potenza dei LED | LED power

\*\*\* Flusso totale in uscita dall'apparecchio a temperatura di lavoro (Ta 25° - 4.000 K) | Total lighting fitting flux output at working temperature (Ta 25° - 4.000 K) | (3.000 K -8% - CRI 90 -10%)

#### KT10440

KIT Sospensione (4 cavi d'acciaio L 2000 mm, n. 4 perni a regolazione millimetrica e n. 4 rosoni cilindrici) a richiesta. | Suspension KIT (no. 4 steel cables L 2000 mm, no. 4 precision adjustment pins and no. 4 cylindrical ceiling roses) on request.

#### KT10441

KIT Sospensione bifido (2 cavi d'acciaio L 2000 mm, n. 2 cilindri di bilanciamento con cavo doppio e n. 2 rosoni cilindrici) a richiesta. | Split suspension KIT (no. 4 steel cables L 2000 mm, no. 2 balancing cylinder with double cable and no. 2 cylindrical ceiling roses) on request.



Accessori | Accessories  
p. 52-53



Descrizione prodotto | Product description  
p. 36



Schema di cablaggio | Connection scheme  
p. XXVIII-XXIX



Fotometrie | Photometries  
p. 37

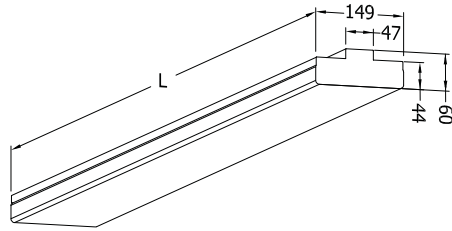

Lunghezze disponibili | Available lengths:  
752 mm - 1127 mm - 1502 mm

# BB TECK

## Schermo Microprismato/Microprismatic diffuser

Ottica a bassa luminanza idonea in ambienti con videotermini.  
Low luminance lighting fitting suitable in rooms with VDT.



A RICHIESTA | ON REQUEST

<b>5Y WARRANTY</b> 5% FAILURE RATE	<b>60.000 h</b> LED LIFETIME L90B10	<b>100.000 h</b> LED LIFETIME L70B50
---------------------------------------	--	---

>90 CRI	EM EN 60910-2-22	DL DALI	PD PUSH DIM
------------	---------------------	------------	----------------

Relamping	Lumen LED*	Watt LED**	Lumen Out***	Watt	Lumen Watt Out	L Lunghezza L Length	Configurazione LED LED configuration	Codice Code	K	Alimentazione Power Supply	Colore Colour
1x36	<b>4100</b>	21	2875	22,5	> 130	752 mm	=====	<b>BBT22</b>	<b>W:</b> 3.000 <b>N:</b> 4.000 <b>C:</b> 6.000  — : CAE A RICHIESTA   ON REQUEST <b>DL:</b> DALI <b>PD:</b> PUSH DIM	<b>01:</b> bianco white	
1x58	<b>5320</b>	28	3870	30	> 126	752 mm	=====	<b>BBT29</b>			
2x36	<b>6150</b>	30,5	4225	32,5	> 130	1127 mm	=====	<b>BBT33</b>			
2x36	<b>7980</b>	42,5	5540	44	> 126	1127 mm	=====	<b>BBT44</b>			
2x35	<b>8200</b>	42	5720	44	> 130	1502 mm	=====	<b>BBT45</b>			
2x58	<b>10680</b>	56	7470	59	> 126	1502 mm	=====	<b>BBT58</b>			

CE	⊕	>80 CRI	IP40 EN 60529	230 V 2014/35/UE	50/60 Hz	IK 07 EN 60068
850° EN 60695	A++ A+	RG 0 EN 62471	01 WHITE	SELV	19 UGR	

TEMPERATURA AMBIENTE MIN E MAX | MIN AND MAX ROOM TEMPERATURE: (-10° +40°)

\* Lumen nominali LED max a 25° | Nominal lumen at max 25°  
 \*\* Potenza dei LED | LED power  
 \*\*\* Flusso totale in uscita dall'apparecchio a temperatura di lavoro (Ta 25° - 4.000 K) | Total lighting fitting flux output at working temperature (Ta 25° - 4.000 K) | (3.000 K -8% - CRI 90 -10%)  
 ★ Emergenza non disponibile per i seguenti codici: BBT22, BBT29  
 Emergency not available for the following codes: BBT22, BBT29

**KT10420**  
 Kit sospensione: n. 2 cavi d'acciaio L=2000 mm - n. 2 perni regolazione millimetrica - n. 2 rosone cilindrico a richiesta. | Suspension kit: no. 2 steel cables L=2000 mm - no. 2 precision adjustment pins - n.2 cylindrical ceiling roses On request.

**BBT-GNT**  
 Giunto per fila continua. | Joint for continuous line application.

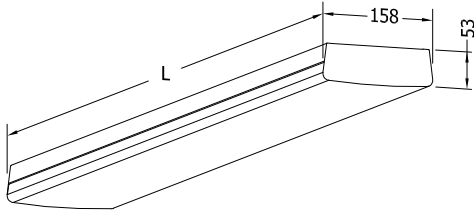

Lunghezze disponibili | Available lengths:  
752 mm - 1127 mm - 1502 mm

# BB LED

## Schermo Rigato Opale/Ribbed Opal diffuser

Apparecchio LED per aree commerciali.  
LED lighting fitting for commercial areas.



A RICHIESTA | ON REQUEST

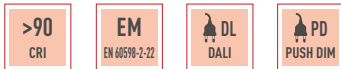

**5Y WARRANTY**  
5% FAILURE RATE

**60.000 h**  
LED LIFETIME L90B10

**100.000 h**  
LED LIFETIME L70B50

Relamping	Lumen LED*	Watt LED**	Lumen Out***	Watt	Lumen Watt Out	L Lunghezza L Length	Configurazione LED LED configuration	Codice Code	K	Alimentazione Power Supply	Colore Colour
1x28	<b>4100</b>	21	2400	22,5	> 109	752 mm	=====	<b>BBL22</b>	<b>W:</b> 3.000 <b>N:</b> 4.000 <b>C:</b> 6.000  — : CAE A RICHIESTA   ON REQUEST <b>DL:</b> DALI <b>PD:</b> PUSH DIM		<b>01:</b> bianco white
1x49	<b>5320</b>	28	3150	30	> 105	752 mm	=====	<b>BBL29</b>			
2x36	<b>6150</b>	30,5	3540	32,5	> 109	1127 mm	=====	<b>BBL33</b>			
2x36	<b>7980</b>	42	4620	44	> 105	1127 mm	=====	<b>BBL44</b>			
2x35	<b>8200</b>	42	4796	44	> 109	1502 mm	=====	<b>BBL45</b>			
2x58	<b>10680</b>	56	6195	59	> 105	1502 mm	=====	<b>BBL58</b>			



TEMPERATURA AMBIENTE MIN E MAX | MIN AND MAX ROOM TEMPERATURE: (-10° +40°)

\* Lumen nominali LED max a 25° | Nominal lumen at max 25°

\*\* Potenza dei LED | LED power

\*\*\* Flusso totale in uscita dall'apparecchio a temperatura di lavoro (Ta 25° - 4.000 K) | Total lighting fitting flux output at working temperature (Ta 25° - 4.000 K) | (3.000 K -8% - CRI 90 -10%)

★ Emergenza non disponibile per i seguenti codici: BBL22, BBL29  
Emergency not available for the following codes: BBL22, BBL29

**KT10440**

KIT Sospensione (4 cavi d'acciaio L 2000 mm, n. 4 perni a regolazione millimetrica e n. 4 rosoni cilindrici) a richiesta. | Suspension KIT (no. 4 steel cables L 2000 mm, no. 4 precision adjustment pins and no. 4 cylindrical ceiling roses) on request.

**KT10441**

KIT Sospensione bifido (2 cavi d'acciaio L 2000 mm, n. 2 cilindri di bilanciamento con cavo doppio e n. 2 rosoni cilindrici) a richiesta. | Split suspension KIT (no. 4 steel cables L 2000 mm, no. 2 balancing cylinder with double cable and no. 2 cylindrical ceiling roses) on request.



Accessori | Accessories  
p. 52-53



Descrizione prodotto | Product description  
p. 38



Schema di cablaggio | Connection scheme  
p. XXVIII-XXIX



Fotometrie | Photometries  
p. 39



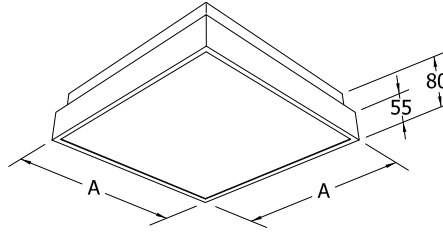

# FLAT SMASH LED

Apparecchio decorativo LED per aree commerciali.  
LED decorative lighting fitting for commercial areas.



A RICHIESTA | ON REQUEST

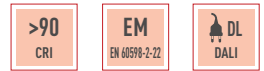

<b>5Y WARRANTY</b> 5% FAILURE RATE	<b>60.000 h</b> LED LIFETIME L90B10	<b>100.000 h</b> LED LIFETIME L70B50
---------------------------------------	--	---

Relamping	Lumen LED*	Watt LED**	Lumen Out***	Watt	Lumen Watt Out	A Dimensioni A Dimensions	Configurazione LED LED configuration	Codice Code	K	Alimentazione Power Supply	Colore Colour
1x22	<b>1500</b>	12	820	12,5	> 66	250x250 mm	○	<b>FLS270</b>	W: 3.000 N: 4.000	- : CAE A RICHIESTA   ON REQUEST DL: DALI	<b>01:</b> bianco white
1x32	<b>2500</b>	19,5	1370	20,5	> 67	300x300 mm	○	<b>FLS380</b>			
1x40	<b>5320</b>	28	2920	30	> 97	400x400 mm	≡	<b>FLS450</b>			

CE	□	>80 CRI	IP40 EN 60529	230 V 2014/35/UE	50/60 Hz	IK 07 EN 60068
850° EN 60695	A++ A+ A	RG 0 EN 62471	01 WHITE	SELV		

TEMPERATURA AMBIENTE MIN E MAX | MIN AND MAX ROOM TEMPERATURE: (-10° +40°)

\* Lumen nominali LED max a 25° | Nominal lumen at max 25°

\*\* Potenza dei LED | LED power

\*\*\* Flusso totale in uscita dall'apparecchio a temperatura di lavoro (Ta 25° - 4.000 K) | Total lighting fitting flux output at working temperature (Ta 25° - 4.000 K) | (3.000 K -8% - CRI 90 -10%)

★ Emergenza non disponibile per i seguenti codici: FLS270  
Emergency not available for the following codes: FLS270

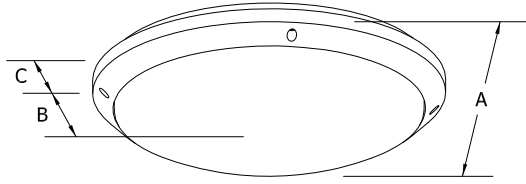

Dimensioni disponibili | Available dimensions:

**A** Ø 270 - **B** 95 mm - **C** 43 mm

**A** Ø 377 - **B** 100 mm - **C** 48 mm



**A RICHIESTA | ON REQUEST**



**5Y WARRANTY**  
5% FAILURE RATE

**60.000 h**  
LED LIFETIME L90B10

**100.000 h**  
LED LIFETIME L70B50

Relamping	Lumen LED*	Watt LED**	Lumen Out***	Watt	Lumen Watt Out	Dimensioni Dimensions	Configurazione LED LED configuration	Codice Code	K	Alimentazione Power Supply	Colore Colour
1x22	<b>1500</b>	12	1090	12,5	> 87	1	○	<b>GDL270</b>	<b>W:</b> 3.000	— : CAE A RICHIESTA   ON REQUEST <b>DL:</b> DALI	<b>01:</b> bianco white
1x32	<b>2500</b>	19,5	1810	20,5	> 88	2	○	<b>GDL370</b>	<b>N:</b> 4.000		



TEMPERATURA AMBIENTE MIN E MAX | MIN AND MAX ROOM TEMPERATURE: **(-20° +40°)**

\* Lumen nominali LED max a 25° | Nominal lumen at max 25°

\*\* Potenza dei LED | LED power

\*\*\* Flusso totale in uscita dall'apparecchio a temperatura di lavoro (Ta 25° - 4.000 K) | Total lighting fitting flux output at working temperature (Ta 25° - 4.000 K) | (3.000 K -8% - CRI 90 -10%)

★ Emergenza non disponibile per i seguenti codici: GDL270  
Emergency not available for the following codes: GDL270



Accessori | Accessories  
p. 52-53



Descrizione prodotto | Product description  
p. 38



Schema di cablaggio | Connection scheme  
p. XX

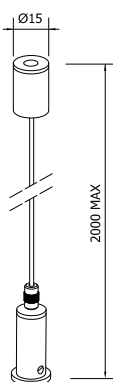

Fotometrie | Photometries  
p. 39

DESCRIZIONE ACCESSORIO  
ACCESSORY DESCRIPTIONIDONEO PER:  
SUITABLE FOR:CODICE  
CODE

Kit sospensione:  
**n. 1 cavo d'acciaio** L=2000 mm  
 n. 1 perno regolazione millimetrica  
 n. 1 rosone cilindrico

*Suspension kit: **no. 1 steel cable**  
 L=2000 mm – no. 1 precision  
 adjustment pin – n. 1 cylindrical  
 ceiling rose*

GAMMA ALGEBRA

KT 10410

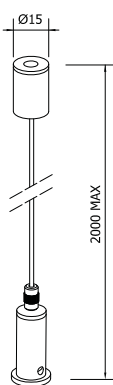

Kit sospensione:  
**n. 2 cavi d'acciaio** L=2000 mm  
 n. 2 perni regolazione millimetrica  
 n. 2 rosoni cilindrici

*Suspension kit:  
**no. 2 steel cables** L=2000 mm  
 no. 2 precision adjustment pins  
 no. 2 cylindrical ceiling roses*

GAMMA ALGEBRA  
BB TECK

KT 10420

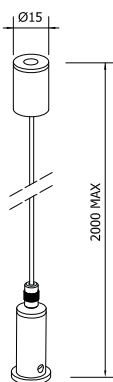

Kit sospensione:  
**n. 4 cavi d'acciaio** L=2000 mm  
 n. 4 perni regolazione millimetrica  
 n. 4 rosoni cilindrici

*Suspension kit:  
**no. 4 steel cables** L=2000 mm  
 no. 4 precision adjustment pins  
 no. 4 cylindrical ceiling roses*

FLOATING LED  
 FLAT LINE LED DARK  
 BB LED  
 FLAT SMASH  
 RELAX LED  
 RELAX LED R  
 RELAX LED SPA  
 RELAX LED SPA R

KT 10440

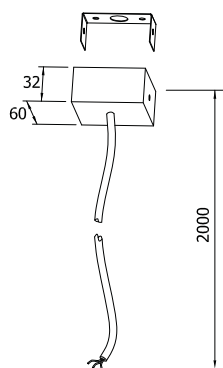

Kit rosone elettrificato completo  
 di cavo trasparente L=2000 mm  
**3x0,75 mm<sup>2</sup>, per soluzioni CAE**

*Electrified ceiling rose complete  
 with transparent cable L=2000 mm  
**3x0,75 mm<sup>2</sup>, for CAE version***

APPARECCHI A SOSPENSIONE  
 SUSPENSION LIGHTING  
 FIXTURES

KT10206

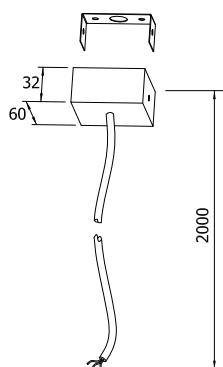
DESCRIZIONE ACCESSORIO  
ACCESSORY DESCRIPTIONIDONEO PER:  
SUITABLE FOR:CODICE  
CODE

Kit rosone elettrificato completo  
di cavo trasparente L=2000 mm  
**5x0,75 mm<sup>2</sup>, per soluzioni EM/DL**

*Electrified ceiling rose complete  
with transparent cable L=2000 mm  
**5x0,75 mm<sup>2</sup>, for EM/DL version***

APPARECCHI A SOSPENSIONE  
*SUSPENSION LIGHTING  
FIXTURES*

KT10206/D

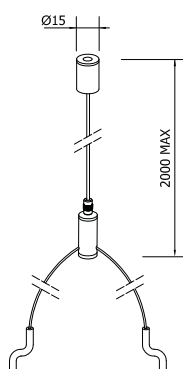

Kit sospensione:  
**n. 2 cavi d'acciaio** L=2000 mm  
n. 2 cilindri di bilanciamento con  
cavo doppio  
n. 2 rosoni cilindrici

*Suspension kit:  
**no. 2 steel cables** L=2000 mm  
no. 2 balancing cylinder with  
double cable  
no. 2 cylindrical ceiling roses*

FLOATING LED  
FLAT LINE LED DARK  
BB LED  
RELAX LED R  
RELAX LED SPA R

KT10441

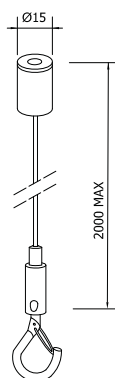

Kit sospensione:  
**n. 1 cavo d'acciaio** L=2000 mm  
n. 1 morsetto automatico con  
regolazione millimetrica  
n. 1 rosone cilindrico

*Suspension kit:  
**no. 1 steel cables** L=2000 mm  
no. 1 precision adjustment  
automatic hook  
no. 1 cylindrical ceiling roses*

BINGO  
BINGO SYSTEM LED  
BINLENS SYSTEM

KT10411



Performance  
illuminotecniche  
nettamente superiori  
all'attuale generazione  
di lampade a LED.

*Lighting performance  
definitely higher compared  
to the others LED fixtures  
in the market nowadays.*



## **DECORATIVI A SOSPENSIONE • DECORATIVE SUSPENSION | PLAFONE • CEILING**

**Sistema di apparecchi illuminotecnici LED per il settore industriale e terziario.**  
LED lighting fixtures system for industries and services.





# GAMMA PRODOTTI | PRODUCT RANGE

## DECORATIVI A SOSPENSIONE • DECORATIVE SUSPENSION PLAFONE • CEILING



### BASKET LED - BASKET LED IP55

p. 58-59

Corpo in lamiera d'alluminio tornito in lastra verniciata con polveri epossidiche previa fosfatazione. Schermo in vetro sabbato. Guarnizioni in silicone. Sistema di fissaggio a sospensione. Sorgente luminosa LED. Emissione diretta. Non idonea per l'applicazione esterna. Alimentazione elettronica CAE. A richiesta: dimmerabile DALI (cod. DL) specificare se con funzione PUSH DIM (cod. PD).

*Spun sheet aluminium body, painted with epoxy powders after phosphating. Sandblasted glass diffuser. Silicon gasket. Suspension mounting system. LED light source. Direct light emission. Not suitable for outdoor application. Built in electronic driver CAE. On request: dimmable DALI (code DL) PUSH DIM function (code PD) to be requested.*



### JERRIMO

p. 60

Corpo in alluminio estruso, verniciato con polveri epossidiche previa fosfatazione. Dissipatore in alluminio estruso. Ottica in alluminio anodizzato lucido fascio medio (cod. MD) o fascio largo (cod. LA). Sistema di fissaggio a plafone o a sospensione. Sorgente luminosa LED. Emissione diretta. Non idonea per l'applicazione esterna. Alimentazione elettronica CAE. A richiesta: dimmerabile DALI (cod. DL) specificare se con funzione PUSH DIM (cod. PD).

*Extruded aluminium body painted with epoxy powders after phosphating. Extruded aluminium heatsink. Polished anodized aluminium louver - medium beam (code MD) or wide beam (code LA). Suspension or ceiling fixing system. LED light source. Direct light emission. Not suitable for outdoor application. Built in electronic driver CAE. On request: dimmable DALI (code DL) PUSH DIM function (code PD) to be requested.*



### PLATO

p. 61

Corpo e riflettore in un unico pezzo in alluminio verniciato con polveri epossidiche previa fosfatazione. Schermo di chiusura in policarbonato opale antiabbagliamento. Installazione a plafone. Sorgente luminosa LED. Emissione diretta. Non idonea per l'applicazione esterna. Alimentazione elettronica CAE. A richiesta: dimmerabile DALI (cod. DL) specificare se con funzione PUSH DIM (cod. PD).

*One piece body reflector, painted with epoxy powders after phosphating. Opal polycarbonate anti-glare closing diffuser. Ceiling mounting. LED light source. Direct light emission. Not suitable for outdoor application. Built-in electronic driver CAE. On request: dimmable DALI (code DL) PUSH DIM function (code PD) to be requested.*



### LULY SHOP

p. 62

Corpo in lamiera d'alluminio tornito in lastra, verniciato con polveri epossidiche previa fosfatazione. Riflettore in alluminio tornito 99,85 %, ossidato e brillantato anodicamente per un elevato rendimento luminoso. Vetro temperato sabbato. Passacavo più cavo uscente. Guarnizione in silicone. Dissipatore in alluminio anodizzato, dove è necessario. Sistema di fissaggio a sospensione con gancio in acciaio zincato. Sorgente luminosa LED. Emissione diretta. Non idonea per l'applicazione esterna. Alimentazione elettronica CAE. A richiesta: dimmerabile DALI (cod. DL) specificare se con funzione PUSH DIM (cod. PD).

*Spun sheet aluminium body painted with epoxy powders after phosphating. Spun aluminium reflector 99,85% oxidized anodized and polished for a high luminous efficiency. Tempered sandblasted glass. Cable gland complete with an outgoing cable. Silicon gasket. Aluminium anodized heatsink, where needed. Suspension mounting system with galvanized steel hook. LED light source. Direct light emission. Not suitable for outdoor application. Built in electronic driver CAE. On request: dimmable DALI (code DL) PUSH DIM function (code PD) to be requested.*



### BOLERO SHOP

p. 63

Corpo in lamiera d'alluminio tornito in lastra, verniciato con polveri epossidiche previa fosfatazione. Riflettore in alluminio tornito 99,85 %, ossidato e brillantato anodicamente per un elevato rendimento luminoso. Vetro temperato sabbato antishock, anello di fissaggio in lamiera zincata con maniglia di apertura e blocco di sicurezza. Guarnizione in silicone. Dissipatore in alluminio estruso. Sistema di fissaggio a sospensione con gancio in acciaio zincato. Sorgente luminosa LED. Emissione diretta. Non idonea per l'applicazione esterna. Alimentazione elettronica CAE. A richiesta: dimmerabile DALI (cod. DL) specificare se con funzione PUSH DIM (cod. PD).

*Spun sheet aluminium body painted with epoxy powders after phosphating. Spun aluminium reflector 99,85% oxidized anodized and polished for a high luminous efficiency. Tempered sandblasted thermal anti-shock glass. Galvanized plate fixing ring with opening handle and safety lock. Silicon gasket. Extruded aluminium heatsink. Suspension mounting system with galvanized steel hook. LED light source. Direct light emission. Not suitable for outdoor application. Built in electronic driver CAE. On request: dimmable DALI (code DL) PUSH DIM function (code PD) to be requested.*



### COCO LED

p. 64

Corpo in alluminio estruso, verniciato con polveri epossidiche previa fosfatazione. Riflettore in alluminio tornito 99,85 %, ossidato e brillantato anodicamente per un elevato rendimento luminoso. Vetro temperato sabbato antishock, anello di fissaggio in lamiera zincata con maniglia di apertura e blocco di sicurezza. Guarnizione in silicone. Dissipatore in alluminio estruso. Sistema di fissaggio a sospensione con gancio in acciaio zincato. Sorgente luminosa LED. Emissione diretta. Non idonea per l'applicazione esterna. Alimentazione elettronica CAE. A richiesta: dimmerabile DALI (cod. DL) specificare se con funzione PUSH DIM (cod. PD).

*Extruded aluminium sheet body painted with epoxy powders after phosphating. Spun aluminium reflector 99,85% oxidized anodized and polished for a high luminous efficiency. Tempered sandblasted thermal anti-shock glass. Galvanized plate fixing ring with opening handle and safety lock. Silicon gasket. Extruded aluminium heatsink. Suspension mounting system with galvanized steel hook. LED light source. Direct light emission. Not suitable for outdoor application. Built in electronic driver CAE. On request: dimmable DALI (code DL) PUSH DIM function (code PD) to be requested.*



# FOTOMETRIE | PHOTOMETRIES

DECORATIVI A SOSPENSIONE • DECORATIVE SUSPENSION  
PLAFONE • CEILING

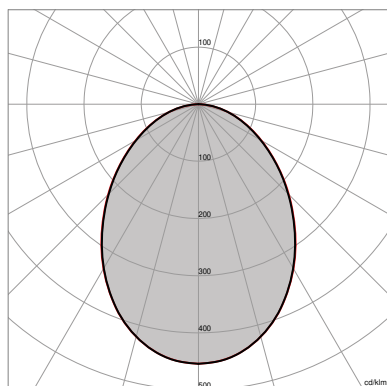

**BASKET LED - BASKET LED IP55**

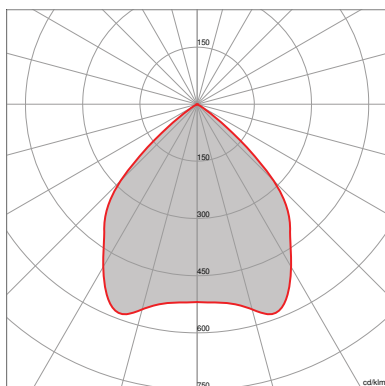

**JERRIMO LA**

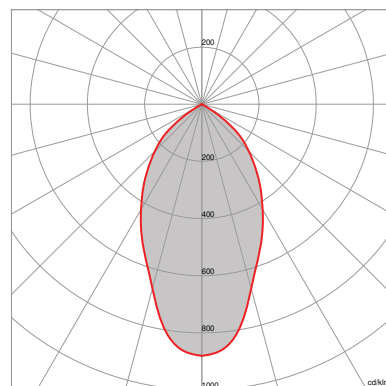

**JERRIMO MD**

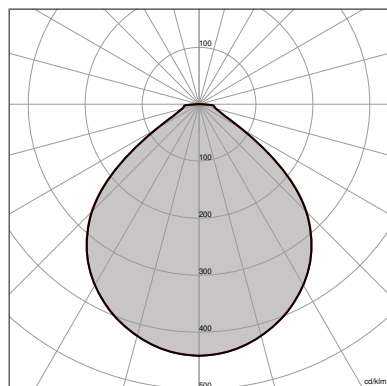

**PLATO**

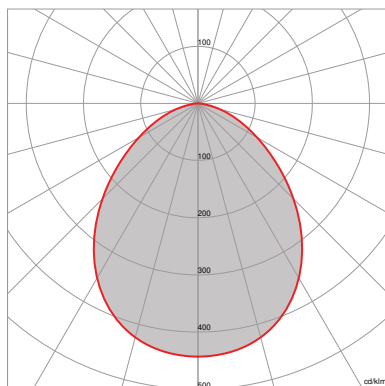

**LULY SHOP**

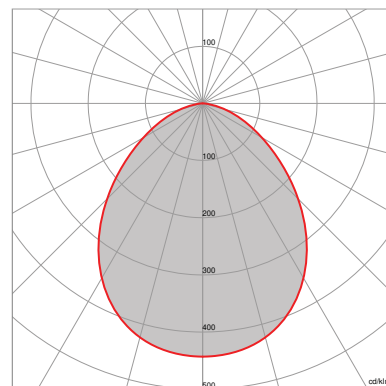

**BOLERO SHOP**

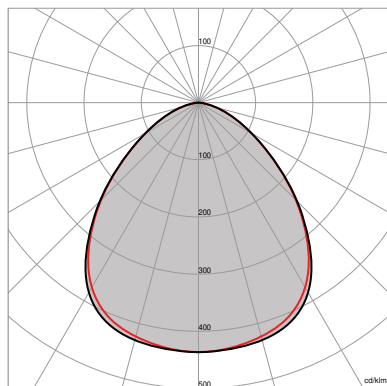

**COCO LED**



Rimani aggiornato  
Keep up to date



# BASKET LED

Sospensione di accento LED per l'illuminazione di aree commerciali IP40D.  
LED suspension lighting fitting IP40D for commercial areas.

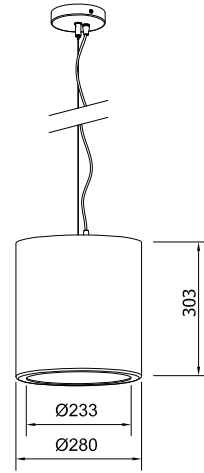

**5Y WARRANTY**  
5% FAILURE RATE

**60.000 h**  
LED LIFETIME L90B10

**100.000 h**  
LED LIFETIME L70B50

**A RICHIESTA | ON REQUEST**

**>90**  
CRI

**EM**  
EN 60978-2-22

**DL**  
DALI

**PD**  
PUSH DIM

Relamping	Lumen LED*	Watt LED**	Lumen Out***	Watt	Lumen Watt Out	Configurazione LED LED configuration	Codice Code	K	Alimentazione Power Supply	Colore Colour
1x70	<b>7300</b>	41	3300	46	> 71	○	<b>BSK33</b>		— : CAE	
1x70	<b>9050</b>	51	4090	57,5	> 71	○	<b>BSK43</b>	<b>W:</b> 3.000	<b>A RICHIESTA   ON REQUEST</b>	<b>01:</b> bianco white
1x100	<b>14000</b>	79	6335	89	> 71	○	<b>BSK64</b>	<b>N:</b> 4.000	<b>DL:</b> DALI <b>PD:</b> PUSH DIM	

<b>CE</b>		<b>&gt;80</b> CRI	<b>IP40</b> EN 60529	<b>230 V</b> 2014/35/UE	<b>50/60</b> Hz	<b>IK 07</b> EN 60068
<b>850°</b> EN 60695	<b>A++</b> A+ A	<b>RG 0</b> EN 62471		<b>01</b> WHITE		

TEMPERATURA AMBIENTE MIN E MAX | MIN AND MAX ROOM TEMPERATURE: **(-10° +40°)**

\* Lumen nominali LED max a 25° | Nominal lumen at max 25°

\*\* Potenza dei LED | LED power

\*\*\* Flusso totale in uscita dall'apparecchio a temperatura di lavoro (Ta 25° - 4.000 K) | Total lighting fitting flux output at working temperature (Ta 25° - 4.000 K) | (3.000 K -8% - CRI 90 -10%)

KIT Sospensione incluso | Suspension KIT included

**A RICHIESTA | ON REQUEST:**

- Installazione a plafone/binario | Ceiling mounting-track mounting
- Schermo a chiusura in policarbonato opale o microprismato | Opal or microprismatic polycarbonate closing screen



Fotometrie | Photometries  
p. 57



Schema di cablaggio | Connection scheme  
p. XXVIII-XXIX



Descrizione prodotto | Product description  
p. 56

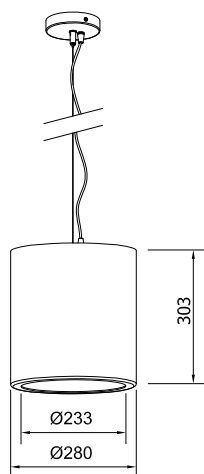

# BASKET LED IP55D

Sospensione di accento LED per l'illuminazione di aree commerciali IP55D.  
LED suspension lighting fitting IP55D for commercial areas.



**A RICHIESTA | ON REQUEST**

>90 CRI
EM EN 60598-2-22
DL DALI
PD PUSH DIM

**5Y WARRANTY**  
5% FAILURE RATE
**60.000 h**  
LED LIFETIME L90B10
**100.000 h**  
LED LIFETIME L70B50

Relamping	Lumen LED*	Watt LED**	Lumen Out***	Watt	Lumen Watt Out	Configurazione LED LED configuration	Codice Code	K	Alimentazione Power Supply	Colore Colour
1x70	<b>7300</b>	41	3300	46	> 71	○	<b>BSIP33</b>		— : CAE A RICHIESTA   ON REQUEST DL: DALI PD: PUSH DIM	<b>01:</b> bianco white
1x70	<b>9050</b>	51	4090	57,5	> 71	○	<b>BSIP43</b>	W: 3.000		
1x100	<b>14000</b>	79	6335	89	> 71	○	<b>BSIP64</b>	N: 4.000		

CE
⏚
>80 CRI
IP55 EN 60529
230 V 2014/35/UE
50/60 Hz
IK 07 EN 60068
  
850° EN 60695
A++ A+ A
RG 0 EN 62471
01 WHITE

TEMPERATURA AMBIENTE MIN E MAX | MIN AND MAX ROOM TEMPERATURE: **(-20° +40°)**

\* Lumen nominali LED max a 25° | Nominal lumen at max 25°

\*\* Potenza dei LED | LED power

\*\*\* Flusso totale in uscita dall'apparecchio a temperatura di lavoro (Ta 25° - 4.000 K) | Total lighting fitting flux output at working temperature (Ta 25° - 4.000 K) | (3.000 K -8% - CRI 90 -10%)

KIT Sospensione incluso | Suspension KIT included

**A RICHIESTA | ON REQUEST:**

- Installazione a plafone/binario | Ceiling mounting-track mounting
- Schermo a chiusura in policarbonato opale o microprismato | Opal or microprismatic polycarbonate closing screen

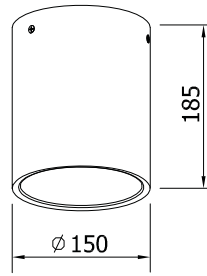

# JERRIMO

Proiettore LED a plafone.  
Ceiling LED spotlight.



**5Y WARRANTY**  
5% FAILURE RATE

**60.000 h**  
LED LIFETIME L90B10

**100.000 h**  
LED LIFETIME L70B50

**A RICHIESTA | ON REQUEST**



Relamping	Lumen LED*	Watt LED**	Lumen Out***	Watt	Lumen Watt Out	Configurazione LED LED configuration	Codice Code	Fascio Beam	K	Alimentazione Power Supply	Colore Colour
1x28	<b>1100</b>	11	935	11,5	> 81	○	<b>JRM17</b>	<b>LA:</b> fascio largo wide beam	<b>W:</b> 3.000	— : CAE	<b>01:</b> bianco white
1x32	<b>2000</b>	18	1500	19	> 79	○	<b>JRM19</b>	<b>MD:</b> fascio medio medium beam	<b>N:</b> 4.000	A RICHIESTA   ON REQUEST <b>DL:</b> DALI <b>PD:</b> PUSH DIM	<b>02:</b> nero black
1x42	<b>3000</b>	29,5	2250	31	> 73	○	<b>JRM23</b>				<b>05:</b> grigio silver

<b>CE</b>		<b>&gt;80</b> CRI	<b>IP43</b> EN 60529	<b>230 V</b> 2014/35/UE	<b>50/60</b> Hz	<b>IK 02</b> EN 60068
<b>850°</b> EN 60695	<b>A++</b> A+ A	<b>RG 0</b> EN 62471		<b>01</b> WHITE	<b>02</b> BLACK	<b>05</b> SILVER

TEMPERATURA AMBIENTE MIN E MAX | MIN AND MAX ROOM TEMPERATURE: (-10° +40°)

\* Lumen nominali LED max a 25° | Nominal lumen at max 25°

\*\* Potenza dei LED | LED power

\*\*\* Flusso totale in uscita dall'apparecchio a temperatura di lavoro (Ta 25° - 4.000 K) | Total lighting fitting flux output at working temperature (Ta 25° - 4.000 K) | (3.000 K -8% - CRI 90 -10%)

**A RICHIESTA / ON REQUEST**

**JRM-SOS** Kit sospensione per Jerrimo | Suspension Kit for Jerrimo

Colori disponibili | Available colours

**01** (bianco/white) - **02** (nero/black) - **05** (grigio/silver)



Fotometrie | Photometries  
p. 57



Schema di cablaggio | Connection scheme  
p. XXVIII-XXIX



Descrizione prodotto | Product description  
p. 56

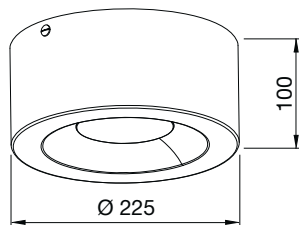

# PLATO

Proiettore LED a plafone.  
Ceiling LED spotlight.



**A RICHIESTA | ON REQUEST**



**5Y WARRANTY**  
5% FAILURE RATE

**60.000 h**  
LED LIFETIME L90B10

**100.000 h**  
LED LIFETIME L70B50

Relamping	Lumen LED*	Watt LED**	Lumen Out***	Watt	Lumen Watt Out	mA	H Altezza H Height	Codice Code	Ottica Optic	K	Alimentazione Power Supply	Colore Colour
2x13	<b>1740</b>	10,5	1465	11	> 133	250	100 mm	<b>PLO1</b>	<b>OP:</b> opale opal	<b>W:</b> 3.000 <b>N:</b> 4.000	--- : CAE A RICHIESTA   ON REQUEST <b>DL:</b> DALI <b>PD:</b> PUSH DIM	<b>O1:</b> bianco white
1x18	<b>2340</b>	14	1975	15,5	> 127	350	100 mm					
2x26	<b>2930</b>	18,5	2470	20	> 133	450	100 mm					
2x32	<b>3220</b>	20	2710	22	> 123	500	100 mm					
2x42	<b>3840</b>	25	3275	26,5	> 123	600	100 mm					



TEMPERATURA AMBIENTE MIN E MAX | MIN AND MAX ROOM TEMPERATURE: (-10° +40°)

\* Lumen nominali LED max a 25° | Nominal lumen at max 25°

\*\* Potenza dei LED | LED power

\*\*\* Flusso totale in uscita dall'apparecchio a temperatura di lavoro (Ta 25° - 4.000 K) | Total lighting fitting flux output at working temperature (Ta 25° - 4.000 K) | (3.000 K -8% - CRI 90 -10%)



Descrizione prodotto | Product description  
p. 56



Schema di cablaggio | Connection scheme  
p. XXVIII-XXIX



Fotometrie | Photometries  
p. 57

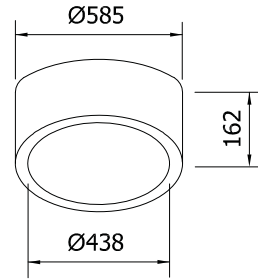

# LULY SHOP

Sospensione di accento LED per l'illuminazione di aree commerciali IP65D.  
LED suspension lighting fitting IP65D for commercial areas.



**5Y WARRANTY**  
5% FAILURE RATE

**60.000 h**  
LED LIFETIME L90B10

**100.000 h**  
LED LIFETIME L70B50

**A RICHIESTA | ON REQUEST**

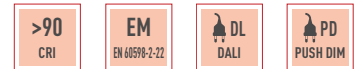

Relamping	Lumen LED*	Watt LED**	Lumen Out***	Watt	Lumen Watt Out	Configurazione LED LED configuration	Codice Code	K	Alimentazione Power Supply	Colore Colour
1x70	<b>6680</b>	38	5030	40	> 126	○	<b>LUSH40</b>		— : CAE	<b>01:</b> bianco white
1x100	<b>9800</b>	55,5	6805	58,5	> 116	○	<b>LUSH64</b>	W: 3.000 N: 4.000	A RICHIESTA   ON REQUEST DL: DALI PD: PUSH DIM	
1x150	<b>14000</b>	73,5	8800	77,5	> 114	○	<b>LUSH85</b>			



TEMPERATURA AMBIENTE MIN E MAX | MIN AND MAX ROOM TEMPERATURE: **(-20° +40°)**

\* Lumen nominali LED max a 25° | Nominal lumen at max 25°

\*\* Potenza dei LED | LED power

\*\*\* Flusso totale in uscita dall'apparecchio a temperatura di lavoro (Ta 25° - 4.000 K) | Total lighting fitting flux output at working temperature (Ta 25° - 4.000 K) | (3.000 K -8% - CRI 90 -10%)

**A RICHIESTA / ON REQUEST**

Installazione a plafone | Ceiling fixing system



Fotometrie | Photometries  
p. 57



Schema di cablaggio | Connection scheme  
p. XXVIII-XXIX



Descrizione prodotto | Product description  
p. 56

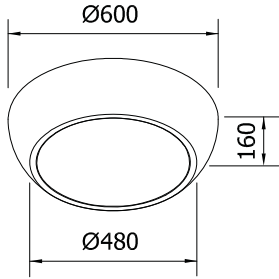

# BOLERO SHOP

Sospensione di accento LED per l'illuminazione di aree commerciali IP65D.  
LED suspension lighting fitting IP65D for commercial areas.



**A RICHIESTA | ON REQUEST**

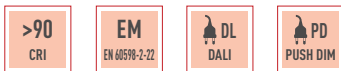

Relamping	Lumen LED*	Watt LED**	Lumen Out***	Watt	Lumen Watt Out	Configurazione LED LED configuration	Codice Code	K	Alimentazione Power Supply	Colore Colour
1x70	<b>6680</b>	38	5030	40	> 126	○	<b>BOSH40</b>		— : CAE A RICHIESTA   ON REQUEST DL: DALI PD: PUSH DIM	<b>01:</b> bianco white
1x100	<b>9800</b>	55,5	6805	58,5	> 116	○	<b>BOSH64</b>	W: 3.000 N: 4.000		
1x150	<b>14000</b>	73,5	8800	77,5	> 114	○	<b>BOSH85</b>			



TEMPERATURA AMBIENTE MIN E MAX | MIN AND MAX ROOM TEMPERATURE: (-20° +40°)

\* Lumen nominali LED max a 25° | Nominal lumen at max 25°

\*\* Potenza dei LED | LED power

\*\*\* Flusso totale in uscita dall'apparecchio a temperatura di lavoro (Ta 25° - 4.000 K) | Total lighting fitting flux output at working temperature (Ta 25° - 4.000 K) | (3.000 K -8% - CRI 90 -10%)

**A RICHIESTA / ON REQUEST**

Installazione a plafone | Ceiling fixing system



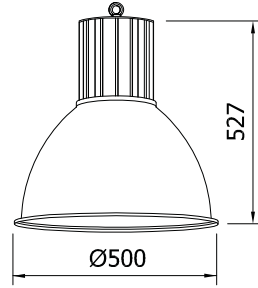

# COCO LED

Sospensione LED per l'illuminazione di aree commerciali e negozi.  
LED fitting for lighting of commercial areas and showroom.



<b>5Y WARRANTY</b> 5% FAILURE RATE	<b>60.000 h</b> LED LIFETIME L90B10	<b>100.000 h</b> LED LIFETIME L70B50
---------------------------------------	--	---

A RICHIESTA | ON REQUEST

<b>&gt;90</b> CRI	<b>EM</b> EN 60980-2-22	<b>DL</b> DALI	<b>PD</b> PUSH DIM
----------------------	----------------------------	-------------------	-----------------------

Relamping	Lumen LED*	Watt LED**	Lumen Out***	Watt	Lumen Watt Out	Configurazione LED LED configuration	Codice Code	K	Alimentazione Power Supply	Colore Colour
1x70	<b>6680</b>	38	5030	40	> 126	○	<b>CCL40</b>		— : CAE A RICHIESTA   ON REQUEST <b>DL:</b> DALI <b>PD:</b> PUSH DIM	<b>02:</b> nero black
1x100	<b>9800</b>	55,5	6805	58,5	> 116	○	<b>CCL64</b>	<b>W:</b> 3.000 <b>N:</b> 4.000		
1x150	<b>14000</b>	73,5	8800	77,5	> 114	○	<b>CCL85</b>			

<b>CE</b>		<b>&gt;80</b> CRI	<b>IP44</b> EN 60529	<b>230 V</b> 2014/35/UE	<b>50/60</b> Hz	<b>IK 07</b> EN 60068
<b>850°</b> EN 60695	<b>A++</b> A+ A	<b>RG 0</b> EN 62471		<b>02</b> BLACK		

TEMPERATURA AMBIENTE MIN E MAX | MIN AND MAX ROOM TEMPERATURE: **(-20° +40°)**

\* Lumen nominali LED max a 25° | Nominal lumen at max 25°

\*\* Potenza dei LED | LED power

\*\*\* Flusso totale in uscita dall'apparecchio a temperatura di lavoro (Ta 25° - 4.000 K) | Total lighting fitting flux output at working temperature (Ta 25° - 4.000 K) | (3.000 K -8% - CRI 90 -10%)

**A RICHIESTA | ON REQUEST**

Ottica in policarbonato opale o trasparente di Ø 350-400-450 mm, schermo di chiusura in policarbonato opale o trasparente.  
*Opal o transparent optic polycarbonate Ø 350-400-450 mm, opal o transparent closing diffusor.*

**INFORMAZIONI TECNICHE | TECHNICAL INFORMATION**

Potenze e flussi disponibili su richiesta, per maggiori informazioni contattare l'ufficio tecnico.  
*Lighting flows available on request, for more information contact the technical office.*

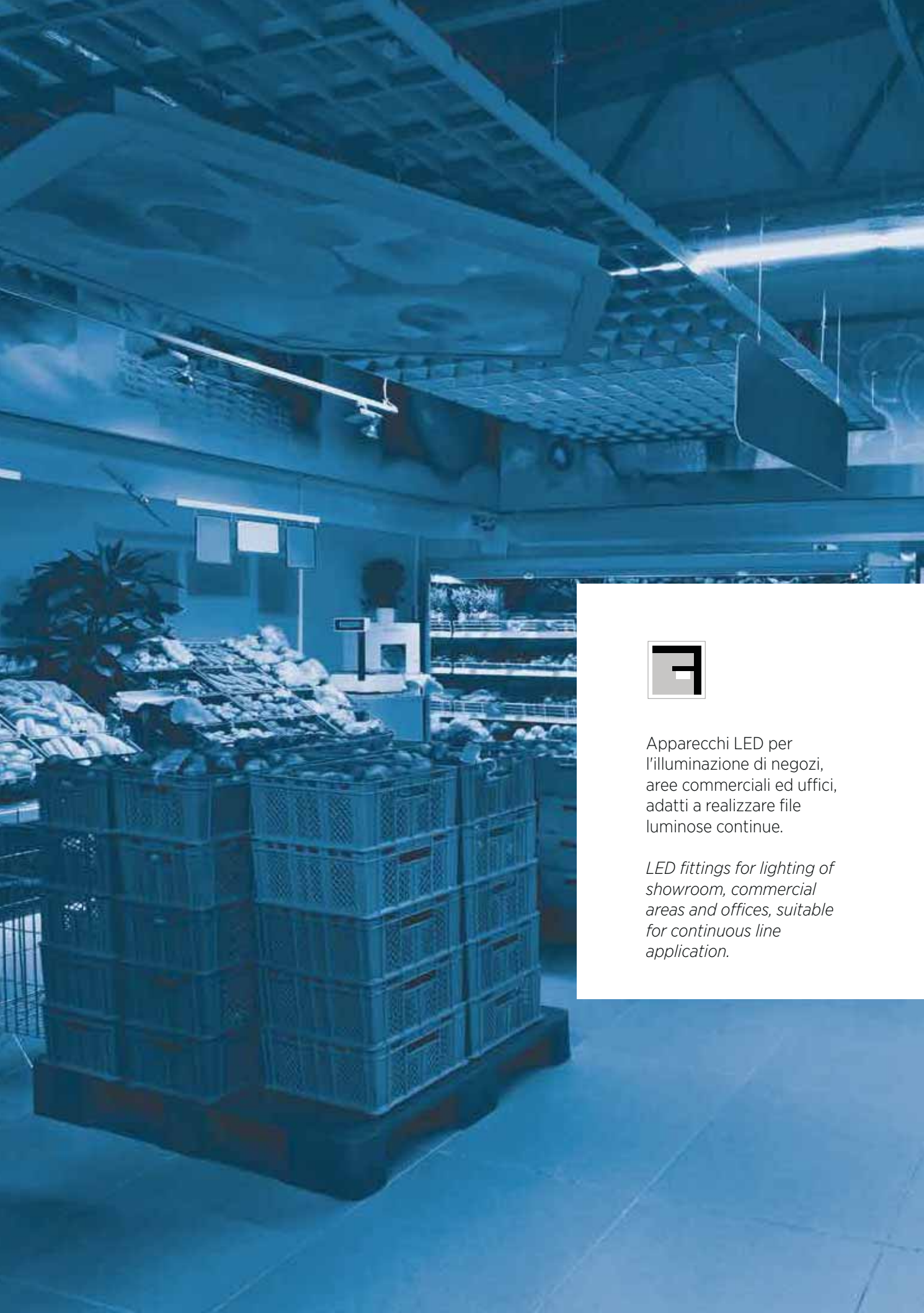

Apparecchi LED per l'illuminazione di negozi, aree commerciali ed uffici, adatti a realizzare file luminose continue.

*LED fittings for lighting of showroom, commercial areas and offices, suitable for continuous line application.*





## **REGLETTE LED "PROLUNGABILI"** **LED LIGHT BATTEN "EXTENDABLE"**

**Reglette LED ideate per garantire uniformità visiva anche applicate a fila continua.**  
LED light batten designed for guaranteeing visual uniformity even with continuous line applications.



# GAMMA PRODOTTI | PRODUCT RANGE

## REGLETTE LED "PROLUNGABILI" LED LIGHT BATTEN "EXTENDABLES"



### DEDICA HF SIMMETRICA | SYMMETRIC

p. 70

Corpo in policarbonato estruso trasparente. Testate in policarbonato stampato trasparente. Schermo in policarbonato estruso trasparente rigato. Prolungabile fino a 8 m (installare a 50 mm dalle pareti). Equipaggiata con cavo di alimentazione da 1,5 m, spina 10A spinotto di connessione per alimentazione in serie. Sistema di fissaggio con aggancio a molla incluso. Accessori: interruttore, spinotto a 90°, prolunghe di giunzione in serie di varie misure, filtro per banco carne. Sorgente luminosa LED. Emissione diretta. Alimentazione CAE elettronica incorporata.

*Extruded polycarbonate transparent body. Printed transparent polycarbonate endcaps. Ribbed extruded transparent polycarbonate diffuser. Extendable up to 8 m (install 50 mm from the wall). Equipped with 1.5 m power cable, 10A plug, output jack for line application. Fastening system with coupling spring included. Accessories: switch, output jack 90°, extension for line applications with different sizes, meat filter. LED light source. Direct light emission. Built-in electronic driver CAE.*



### DEDICA ASL HF ASIMMETRICA | ASYMMETRIC

p. 71

Corpo in policarbonato estruso trasparente. Testate in policarbonato stampato trasparente. Schermo in policarbonato estruso trasparente rigato. Prolungabile fino a 8 m (installare a 50mm dalle pareti). Equipaggiata con cavo di alimentazione da 1,5 m, spina 10A spinotto di connessione per alimentazione in serie. Sistema di fissaggio con aggancio a molla incluso. Accessori: interruttore, spinotto a 90°, prolunghe di giunzione in serie di varie misure, filtro per banco carne. Sorgente luminosa LED. Emissione diretta. Alimentazione CAE elettronica incorporata.

*Extruded polycarbonate transparent body. Printed transparent polycarbonate endcaps. Ribbed extruded transparent polycarbonate diffuser. Extendable up to 8 m (install 50 mm from the wall). Equipped with 1.5 m power cable, 10A plug, output jack for line application. Fastening system with coupling spring included. Accessories: switch, output jack 90°, extension for line applications with different sizes, meat filter. LED light source. Direct light emission. Built-in electronic driver CAE.*



### PROFILI HF SIMMETRICA | SYMMETRIC

p. 72

Corpo in policarbonato estruso trasparente. Testate in policarbonato stampato trasparente. Schermo in policarbonato estruso trasparente rigato. Prolungabile fino a 8 m (installare a 50mm dalle pareti). Equipaggiata con cavo di alimentazione da 1,5 m, spina 10A spinotto di connessione per alimentazione in serie. Sistema di fissaggio con aggancio a molla incluso. Accessori: spinotto a 90°, prolunghe di giunzione in serie di varie misure. Sorgente luminosa LED. Emissione diretta. Alimentazione CAE elettronica incorporata.

*Transparent extruded polycarbonate body. Transparent printed polycarbonate end caps. Transparent Ribbed extruded polycarbonate diffuser. Extendable up to 8 m (install 50 mm from the wall). Equipped with 1.5 m power cable, 10A plug, output jack for line application. Fastening system with coupling spring included. Accessories: 90° output jack, extensions for line application with different sizes. LED light source. Direct light emission. Built-in electronic driver CAE.*



### REK LED - REK LED SENSOR SIMMETRICA | SYMMETRIC

p. 76-77

Corpo in lamiera d'acciaio pressopiegata verniciata con polveri epossidiche previa fosfatazione. Riflettore in alluminio speculare. Diffusore in metacrilato opale. Sistema di fissaggio a sospensione o a plafone. Sorgente luminosa LED. Emissione diretta. Non idonea per l'applicazione esterna. Alimentazione elettronica CAE. A richiesta: dimmerabile DALI (cod. DL) specificare se con funzione PUSH DIM (cod. PD).

*Bent sheet steel body painted with epoxy powders after phosphating. Aluminium specular reflector. Opal methacrylate diffuser. Suspension or ceiling fixing system. LED light source. Direct light emission. Not suitable for outdoor application. Built in electronic driver CAE. On request: dimmable DALI (code DL) PUSH DIM function (code PD) to be requested.*

# FOTOMETRIE | PHOTOMETRIES

## REGLETTE LED "PROLUNGABILI" LED LIGHT BATTEN "EXTENDABLES"

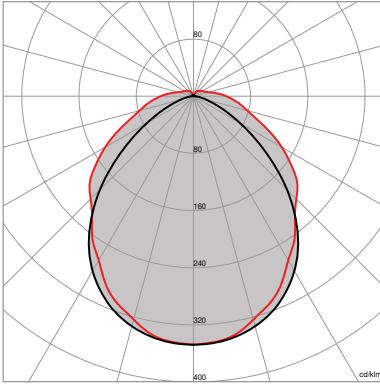

**DEDICA HF**  
SIMMETRICA | SYMMETRIC

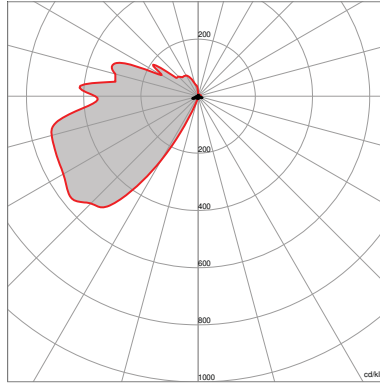

**DEDICA ASL HF**  
ASSIMMETRICA | ASYMMETRIC

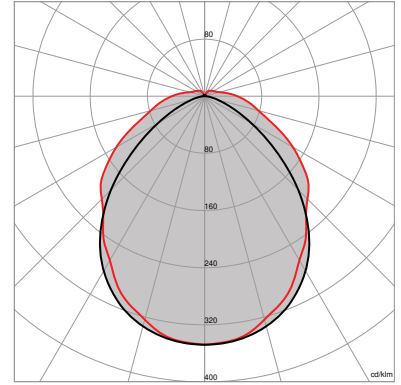

**PROFILI HF**  
SIMMETRICA | SYMMETRIC

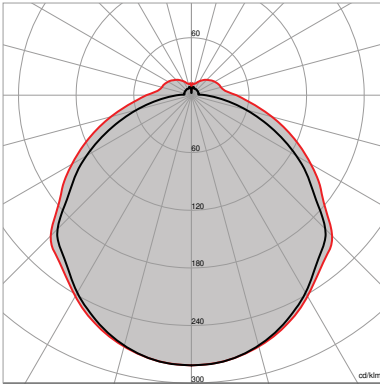

**REK LED / REK LED SENSOR**  
SIMMETRICA | SYMMETRIC



Rimani aggiornato  
Keep up to date

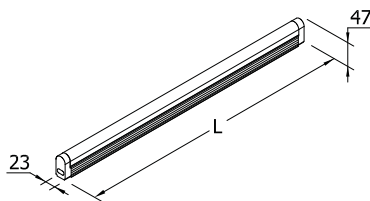

**HF:** 1847 Lumen Out/m  
13,50 Watt/m

## DEDICA HF

### SIMMETRICA/SYMMETRIC

Reglette LED diffusione simmetrica.  
LED symmetric light batten.



A RICHIESTA | ON REQUEST

>90  
CRI

**5Y WARRANTY**  
5% FAILURE RATE

**60.000 h**  
LED LIFETIME L90B10

**100.000 h**  
LED LIFETIME L70B50

Relamping	Lumen LED*	Watt LED**	Lumen Out***	Watt	Lumen Watt Out	L Lunghezza L Length	Configurazione LED LED configuration	Codice Code	K	Alimentazione Power Supply
1x6	<b>620</b>	3,5	545	4	> 136	323 mm	—	<b>DHF11</b>	W: 3.000 N: 4.000	— : CAE
1x14	<b>1240</b>	7	1090	8	> 136	603 mm	—	<b>DHF12</b>		
1x21	<b>1860</b>	11	1635	12	> 136	883 mm	—	<b>DHF13</b>		
1x28	<b>2480</b>	14,5	2180	16	> 136	1163 mm	—	<b>DHF14</b>		
1x35	<b>3100</b>	18	2725	20	> 136	1443 mm	—	<b>DHF15</b>		



TEMPERATURA AMBIENTE MIN E MAX | MIN AND MAX ROOM TEMPERATURE: (-10° +40°)

\* Lumen nominali LED max a 25° | Nominal lumen at max 25°

\*\* Potenza dei LED | LED power

\*\*\* Flusso totale in uscita dall'apparecchio a temperatura di lavoro (Ta 25° - 4.000 K) | Total lighting fitting flux output at working temperature (Ta 25° - 4.000 K) | (3.000 K -8% - CRI 90 -10%)

**A RICHIESTA / ON REQUEST**

• Disponibile versione con filtro carne | Available with meat filter



Fotometrie | Photometries  
p. 69



Schema di cablaggio | Connection scheme  
p. XXVIII-XXIX



Descrizione prodotto | Product description  
p. 68



Accessori | Accessories  
p. 75



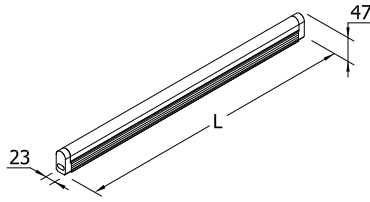

**HF:** 1847 Lumen Out/m  
13,50 Watt/m



**A RICHIESTA | ON REQUEST**

**>90**  
CRI

# DEDICA ASL HF

## ASIMMETRICA/ASYMMETRIC

Reglette LED diffusione asimmetrica.  
LED asymmetric light batten.

**5Y WARRANTY**  
5% FAILURE RATE

**60.000 h**  
LED LIFETIME L90B10

**100.000 h**  
LED LIFETIME L70B50

Relamping	Lumen LED*	Watt LED**	Lumen Out***	Watt	Lumen Watt Out	L Lunghezza L Length	Configurazione LED LED configuration	Code Code	K	Alimentazione Power Supply
1x6	<b>620</b>	3,5	545	4	> 136	323 mm	—	<b>DAHFI1</b>	W: 3.000 N: 4.000	— : CAE
1x14	<b>1240</b>	7	1090	8	> 136	603 mm	—	<b>DAHFI2</b>		
1x21	<b>1860</b>	11	1635	12	> 136	883 mm	—	<b>DAHFI3</b>		
1x28	<b>2480</b>	14,5	2180	16	> 136	1163 mm	—	<b>DAHFI4</b>		
1x35	<b>3100</b>	18	2725	20	> 136	1443 mm	—	<b>DAHFI5</b>		



TEMPERATURA AMBIENTE MIN E MAX | MIN AND MAX ROOM TEMPERATURE: (-10° +40°)

\* Lumen nominali LED max a 25° | Nominal lumen at max 25°

\*\* Potenza dei LED | LED power

\*\*\* Flusso totale in uscita dall'apparecchio a temperatura di lavoro (Ta 25° - 4.000 K) | Total lighting fitting flux output at working temperature (Ta 25° - 4.000 K) | (3.000 K -8% - CRI 90 -10%)

**A RICHIESTA / ON REQUEST**

• Disponibile versione con filtro carne | Available with meat filter



Accessori | Accessories  
p. 75



Descrizione prodotto | Product description  
p. 68



Schema di cablaggio | Connection scheme  
p. XXVIII-XXIX



Fotometrie | Photometries  
p. 69

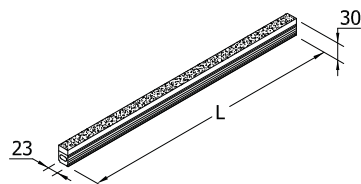

**HF:** 1847 Lumen Out/m  
13,50 Watt/m

## PROFILI HF

### SIMMETRICA/SYMMETRIC

Reglette LED diffusione simmetrica ideata per garantire uniformità visiva anche applicata a fila continua.

*LED symmetrical light designed in order to guarantee a visual uniformity even with continuous line applications.*

**5Y WARRANTY**  
5% FAILURE RATE

**60.000 h**  
LED LIFETIME L<sub>90B10</sub>

**100.000 h**  
LED LIFETIME L<sub>70B50</sub>



**A RICHIESTA | ON REQUEST**

**>90**  
CRI

Relamping	Lumen LED*	Watt LED**	Lumen Out***	Watt	Lumen Watt Out	L Lunghezza L Length	Configurazione LED LED configuration	Code Code	K	Alimentazione Power Supply
1x6	<b>620</b>	3,5	545	4	> 136	296 mm	—	<b>PRLHF11</b>	W: 3.000 N: 4.000	— : CAE
1x14	<b>1240</b>	7	1090	8	> 136	576 mm	—	<b>PRLHF12</b>		
1x21	<b>1860</b>	11	1635	12	> 136	856 mm	—	<b>PRLHF13</b>		
1x28	<b>2480</b>	14,5	2180	16	> 136	1136 mm	—	<b>PRLHF14</b>		
1x35	<b>3100</b>	18	2725	20	> 136	1416 mm	—	<b>PRLHF15</b>		



TEMPERATURA AMBIENTE MIN E MAX | MIN AND MAX ROOM TEMPERATURE: (-10° +40°)

\* Lumen nominali LED max a 25° | Nominal lumen at max 25°

\*\* Potenza dei LED | LED power

\*\*\* Flusso totale in uscita dall'apparecchio a temperatura di lavoro (Ta 25° - 4.000 K) | Total lighting fitting flux output at working temperature (Ta 25° - 4.000 K) | (3.000 K -8% - CRI 90 -10%)



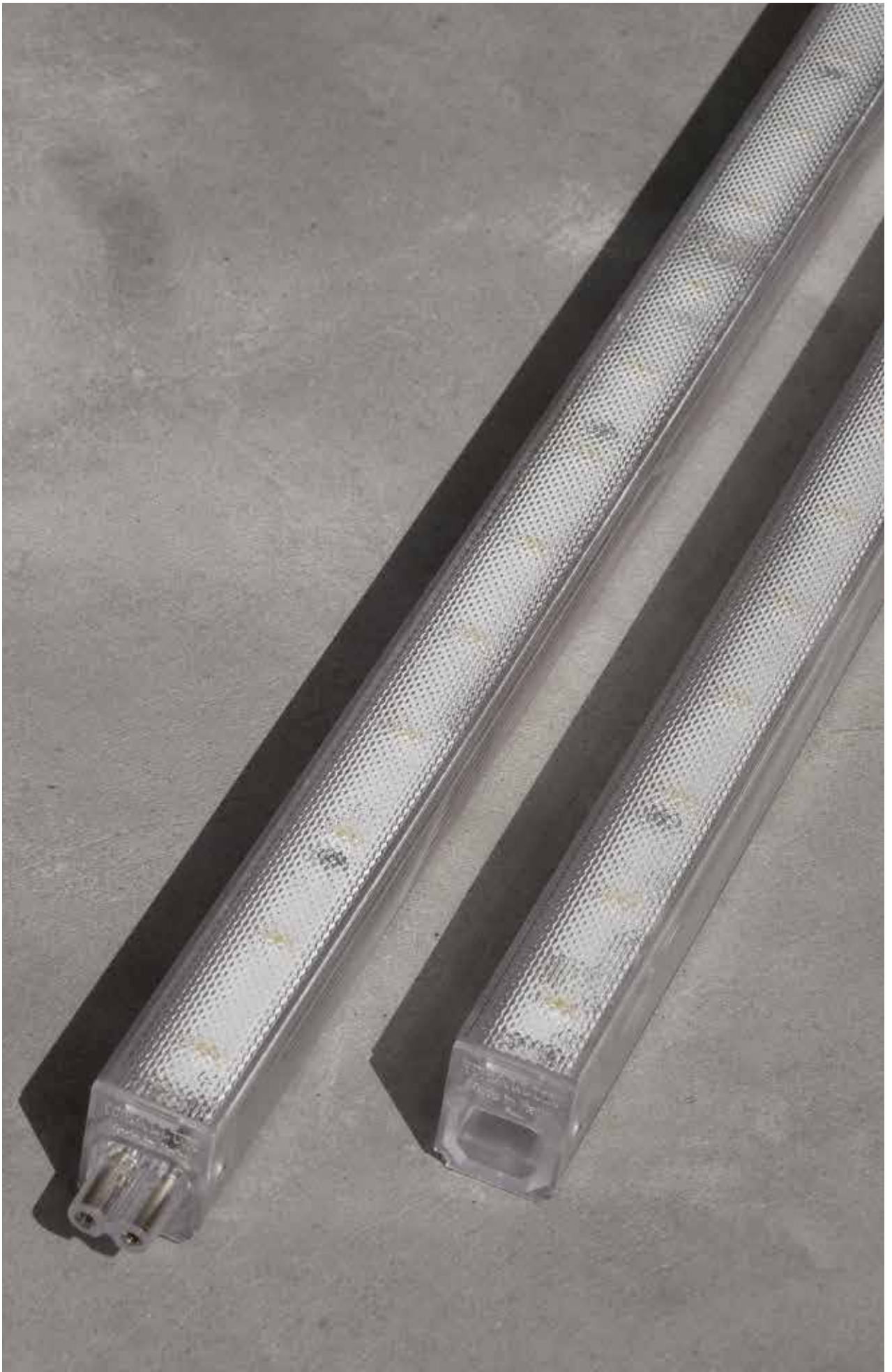

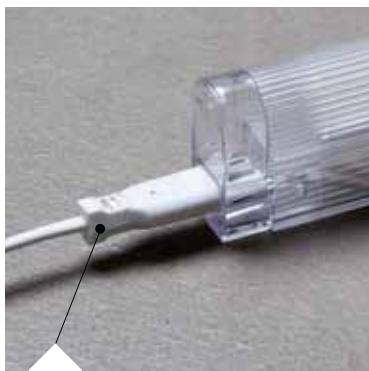

Cavo alimentazione con spinotto.  
*Power cable with output jack.*

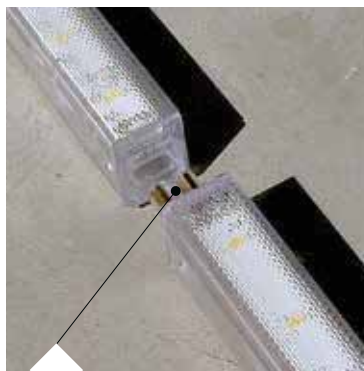

Connettore per fila continua incluso.  
*Output jack for line application.*



Alimentazione incorporata inclusa.  
*Built-in electronic driver.*





Esempio installazione.  
Perfetta continuità nei LED.  
*Installation example.  
Perfect continuous LED line.*



Fila continua Dedicata.  
*Continuous line Dedicata.*

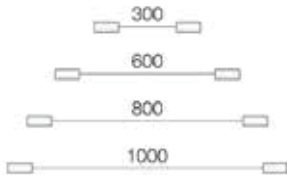

Schermo microprismatico antiabbagliamento.  
*Antiglare microprismatic diffuser.*

DESCRIZIONE ACCESSORIO ACCESSORY DESCRIPTION	IDONEO PER: SUITABLE FOR:	CODICE CODE	
	Interruttore <i>Switch</i>	DEDICA HF DEDICA ASL HF	<b>535INT</b>
	Spinotto 90° <i>Output jack 90°</i>	DEDICA HF DEDICA ASL HF	<b>535/SP/90</b>
	Prolunga lunghezza 300-600-800-1000 m.  <i>Extensione for line applications 300-600-800-1000 m.</i>	DEDICA HF DEDICA ASL HF PROFILI HF	<b>535/P/300</b> <b>535/P/600</b> <b>535/P/800</b> <b>535/P/1000</b>

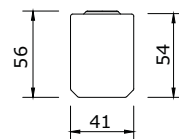
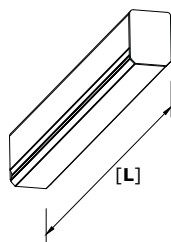

# REK LED

## SIMMETRICA/SYMMETRIC

Reglette LED diffusione simmetrica. Corpo in lamiera verniciata, diffusore in metacrilato opale.  
LED symmetric light batten. Painted sheet body, methacrylate opal diffuser.



A RICHIESTA | ON REQUEST

<b>5Y WARRANTY</b> 5% FAILURE RATE	<b>60.000 h</b> LED LIFETIME L90B10	<b>100.000 h</b> LED LIFETIME L70B50
---------------------------------------	--	---

>90 CRI	EM EN 60910-2-22	DL DALI	PD PUSH DIM
------------	---------------------	------------	----------------

Relamping	Lumen LED*	Watt LED**	Lumen Out***	Watt	Lumen Watt Out	L Lunghezza L Length	Configurazione LED LED configuration	Code Code	K	Alimentazione Power Supply
1x14	<b>1350</b>	7,5	1080	8	> 135	570 mm	—	<b>RK01</b>	<b>W:</b> 3.000  <b>N:</b> 4.000  — : CAE A RICHIESTA   ON REQUEST <b>DL:</b> DALI <b>PD:</b> PUSH DIM	
2x14	<b>2700</b>	15	2160	16	> 135	570 mm	—	<b>RK02</b>		
1x28	<b>3075</b>	17	2460	18	> 137	1150 mm	—	<b>RK03</b>		
2x28	<b>6120</b>	34	4896	36	> 136	1150 mm	—	<b>RK04</b>		
1x35	<b>4100</b>	23	3280	24	> 137	1520 mm	—	<b>RK05</b>		
2x35	<b>8000</b>	46	6400	48	> 133	1520 mm	—	<b>RK06</b>		
1x80	<b>5200</b>	28,5	4160	30	> 139	1900 mm	—	<b>RK10</b>		
2x80	<b>10000</b>	57	8000	60	> 133	1900 mm	—	<b>RK11</b>		

CE	□	>80 CRI	IP40 EN 60529	230 V 2014/35/UE	50/60 Hz	IK 07 EN 60068
850° EN 60695	A++ A	RG 0 EN 62471	01 WHITE	🏠	⚡	

TEMPERATURA AMBIENTE MIN E MAX | MIN AND MAX ROOM TEMPERATURE: (-10° +40°)

\* Lumen nominali LED max a 25° | Nominal lumen at max 25°

\*\* Potenza dei LED | LED power

\*\*\* Flusso totale in uscita dall'apparecchio a temperatura di lavoro (Ta 25° - 4.000 K) | Total lighting fitting flux output at working temperature (Ta 25° - 4.000 K) | (3.000 K -8% - CRI 90 -10%)

★ Emergenza non disponibile per i seguenti codici: RK01-RK02  
Emergency not available for the following codes: RK01-RK02

**SENSOR:**

- Tempo di accensione pre-impostato **5 minuti**
- Pre-set switch-on time **5 minutes**

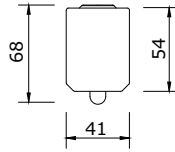
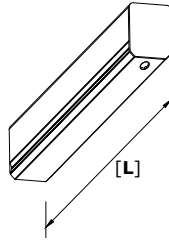

# REK LED SENSOR

## SIMMETRICA/SYMMETRIC

Reglette LED diffusione simmetrica. Corpo in lamiera verniciata, diffusore in metacrilato opale.  
LED symmetric light batten. Painted sheet body, methacrylate opal diffuser.



A RICHIESTA | ON REQUEST



**5Y WARRANTY**  
5% FAILURE RATE

**60.000 h**  
LED LIFETIME L90B10

**100.000 h**  
LED LIFETIME L70B50

Relamping	Lumen LED*	Watt LED**	Lumen Out***	Watt	Lumen Watt Out	L Lunghezza L Length	Configurazione LED LED configuration	Codice Code	K	Alimentazione Power Supply
1x14	<b>1350</b>	7,5	1080	8	> 135	570 mm	—	<b>RKS01</b>		— : CAE A RICHIESTA   ON REQUEST <b>DL:</b> DALI <b>PD:</b> PUSH DIM
2x14	<b>2700</b>	15	2160	16	> 135	570 mm	—	<b>RKS02</b>		
1x28	<b>3075</b>	17	2460	18	> 137	1150 mm	—	<b>RKS03</b>		
2x28	<b>6120</b>	34	4896	36	> 136	1150 mm	—	<b>RKS04</b>	W: 3.000	
1x35	<b>4100</b>	23	3280	24	> 137	1520 mm	—	<b>RKS05</b>	N: 4.000	
2x35	<b>8000</b>	46	6400	48	> 133	1520 mm	—	<b>RKS06</b>		
1x80	<b>5200</b>	28,5	4160	30	> 139	1900 mm	—	<b>RKS10</b>		
2x80	<b>10000</b>	57	8000	60	> 133	1900 mm	—	<b>RKS11</b>		



TEMPERATURA AMBIENTE MIN E MAX | MIN AND MAX ROOM TEMPERATURE: (-10° +40°)

\* Lumen nominali LED max a 25° | Nominal lumen at max 25°

\*\* Potenza dei LED | LED power

\*\*\* Flusso totale in uscita dall'apparecchio a temperatura di lavoro (Ta 25° - 4.000 K) | Total lighting fitting flux output at working temperature (Ta 25° - 4.000 K) | (3.000 K -8% - CRI 90 -10%)

★ Emergenza non disponibile per i seguenti codici: RKS01-RKS02  
Emergency not available for the following codes: RKS01-RKS02



Descrizione prodotto | Product description  
p. 68



Schema di cablaggio | Connection scheme  
p. XXVIII-XXIX



Fotometrie | Photometries  
p. 69





Performance  
illuminotecniche  
nettamente superiori  
all'attuale generazione di  
lampade LED.

*Lighting performance  
definitely higher compared  
to the others LED fixtures in  
the market nowadays.*



## **INCASSO** RECESSED

Sistema di apparecchi illuminotecnici LED ad incasso per il terziario.  
*LED recessed lighting fittings system for services.*

# GAMMA PRODOTTI | PRODUCT RANGE

## INCASSO RECESSED

### ALG UP OP

p. 90

Corpo in lamiera d'acciaio pressopiegata verniciata con polveri epossidiche previa fosfatazione. Ottica in alluminio ad alto rendimento con funzione di dissipatore. Schermo in policarbonato opale. Installazione ad incasso. Testate di chiusura incluse. Sorgente luminosa LED. Emissione diretta. Non idonea per l'applicazione esterna. Alimentazione elettronica CAE. A richiesta: dimmerabile DALI (cod. DL) specificare se con funzione PUSH DIM (cod. PD).

*Bent steel sheet body painted with epoxy powders after phosphating. High performance aluminum louver with heatsink function. Opal polycarbonate diffuser. Recessed mounting. Endcovers included. LED light source. Direct light emission. Not suitable for outdoor application. Built in electronic driver CAE. On request: dimmable DALI (code DL) PUSH DIM function (code PD) to be requested.*



### ALG UP MP

p. 91

Corpo in lamiera d'acciaio pressopiegata verniciata con polveri epossidiche previa fosfatazione. Ottica in alluminio ad alto rendimento con funzione di dissipatore. Schermo in policarbonato microprismato, idoneo per ambienti con videotermini. Installazione ad incasso. Testate di chiusura incluse. Sorgente luminosa LED. Emissione diretta. Non idonea per l'applicazione esterna. Alimentazione elettronica CAE. A richiesta: dimmerabile DALI (cod. DL) specificare se con funzione PUSH DIM (cod. PD).

*Bent steel sheet body painted with epoxy powders after phosphating. High performance aluminum louver with heatsink function. Microprismatic polycarbonate diffuser, suitable in rooms with VDT. Recessed mounting. Endcovers included. LED light source. Direct light emission. Not suitable for outdoor application. Built in electronic driver CAE. On request: dimmable DALI (code DL) PUSH DIM function (code PD) to be requested.*

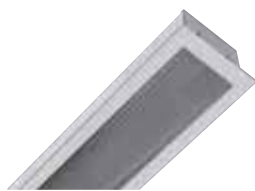

### ALG UP SMALL OP

p. 92

Corpo in lamiera d'acciaio pressopiegata verniciata con polveri epossidiche previa fosfatazione. Ottica in alluminio ad alto rendimento con funzione di dissipatore. Fissaggio a scatto (senza viti) per una facile e veloce installazione. Schermo diffondente in policarbonato opale. Installazione ad incasso. Testate di chiusura incluse. Sorgente luminosa LED. Emissione diretta. Non idonea per l'applicazione esterna. Alimentazione elettronica CAE. A richiesta: dimmerabile DALI (cod. DL) specificare se con funzione PUSH DIM (cod. PD).

*Bent steel sheet body painted with epoxy powders after phosphating. High performance aluminum louver with heatsink function. Opal polycarbonate diffuser. Recessed mounting snap-fastening system without screws for an easy installation. Endcovers included. LED light source. Direct light emission. Not suitable for outdoor application. Built in electronic driver CAE. On request: dimmable DALI (code DL) PUSH DIM function (code PD) to be requested.*



### ALG UP SMALL MP

p. 93

Corpo in lamiera d'acciaio pressopiegata verniciata con polveri epossidiche previa fosfatazione. Ottica in alluminio ad alto rendimento con funzione di dissipatore. Fissaggio a scatto (senza viti) per una facile e veloce installazione. Schermo diffondente in policarbonato microprismato. Installazione ad incasso. Testate di chiusura incluse. Sorgente luminosa LED. Emissione diretta. Non idonea per l'applicazione esterna. Alimentazione elettronica CAE. A richiesta: dimmerabile DALI (cod. DL) specificare se con funzione PUSH DIM (cod. PD).

*Bent steel sheet body painted with epoxy powders after phosphating. High performance aluminum louver with heatsink function. Microprismatic polycarbonate diffuser. Recessed mounting. Snap-fastening system without screws for an easy installation. Endcovers included. LED light source. Direct light emission. Not suitable for outdoor application. Built in electronic driver CAE. On request: dimmable DALI (code DL) PUSH DIM function (code PD) to be requested.*



### ALG UP MICRO OP

p. 94

Corpo in lamiera d'acciaio pressopiegata verniciata con polveri epossidiche previa fosfatazione. Ottica in alluminio ad alto rendimento con funzione di dissipatore. Fissaggio a scatto (senza viti) per una facile e veloce installazione. Schermo in policarbonato opale. Installazione ad incasso. Testate di chiusura incluse. Sorgente luminosa LED. Emissione diretta. Non idonea per l'applicazione esterna. Alimentazione elettronica CAE. A richiesta: dimmerabile DALI (cod. DL) specificare se con funzione PUSH DIM (cod. PD).

*Bent steel sheet body painted with epoxy powders after phosphating. High performance aluminum louver with heatsink function. Opal polycarbonate diffuser. Recessed mounting. Snap-fastening system without screws for an easy installation. Endcovers included. LED light source. Direct light emission. Not suitable for outdoor application. Built in electronic driver CAE. On request: dimmable DALI (code DL) PUSH DIM function (code PD) to be requested.*



# FOTOMETRIE | PHOTOMETRIES

**INCASSO**  
RECESSED

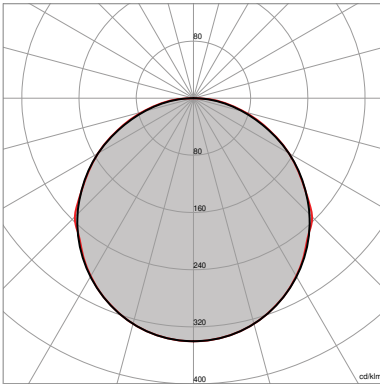

**ALG UP OP**

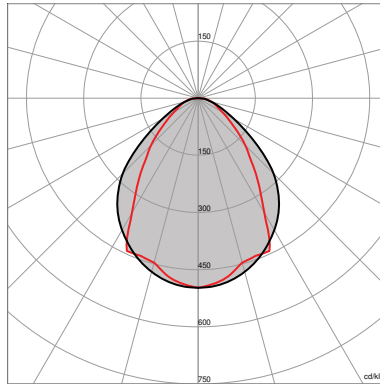

**ALG UP MP**

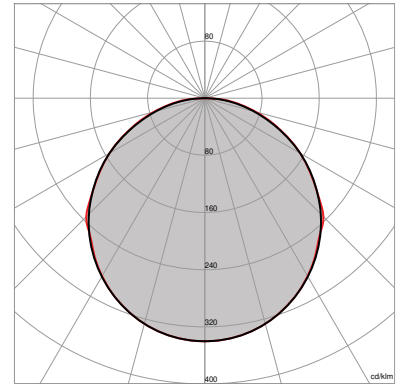

**ALG UP SMALL OP**

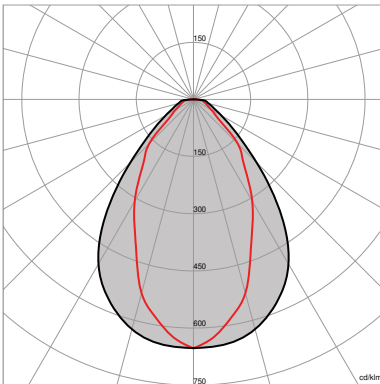

**ALG UP SMALL MP**

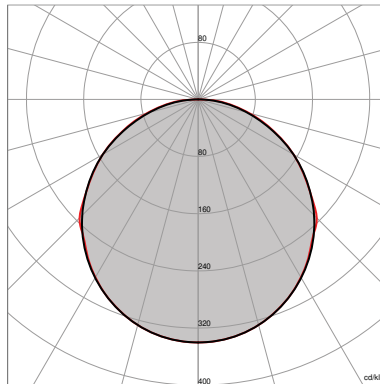

**ALG UP MICRO OP**



Rimani aggiornato  
Keep up to date





# GAMMA PRODOTTI | PRODUCT RANGE

## INCASSO RECESSED

### ALG UP MICRO MP

p. 95

Corpo in lamiera d'acciaio pressopiegata verniciata con polveri epossidiche previa fosfatazione. Ottica in alluminio ad alto rendimento con funzione di dissipatore. Fissaggio a scatto (senza viti) per una facile e veloce installazione. Schermo in policarbonato microprismato. Installazione ad incasso. Testate di chiusura escluse. Sorgente luminosa LED. Emissione diretta. Non idonea per l'applicazione esterna. Alimentazione elettronica CAE. A richiesta: dimmerabile DALI (cod. DL) specificare se con funzione PUSH DIM (cod. PD).

*Bent steel sheet body painted with epoxy powders after phosphating. High performance aluminum louver with heatsink function. Microprismatic polycarbonate diffuser. Recessed mounting. Snap-fastening system without screws for an easy installation. Endcovers included. LED light source. Direct light emission. Not suitable for outdoor application. Built in electronic driver CAE. On request: dimmable DALI (code DL) PUSH DIM function (code PD) to be requested.*



### CONTROLLED EB DARK

p. 96

Corpo e telaio in lamiera d'acciaio pressopiegata verniciata con polveri epossidiche previa fosfatazione. Ottica in alluminio speculare con copertura microprismato idoneo per ambienti con videoterminali. Sistema di fissaggio ad incasso con staffe regolabili. Sorgente luminosa LED. Emissione diretta. Non idonea per l'applicazione esterna. Alimentazione elettronica CAE. A richiesta: dimmerabile DALI (cod. DL) specificare se con funzione PUSH DIM (cod. PD).

*Bent steel sheet body and frame painted with epoxy powders after phosphating. Specular aluminum louver with microprismatic diffuser suitable in rooms with VDT. Recessed fixing system with adjustable brackets. LED light source. Direct light emission. Not suitable for outdoor application. Built in electronic driver CAE. On request: dimmable DALI (code DL) PUSH DIM function (code PD) to be requested.*

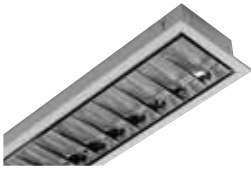

### CONTROLLED EB UGR

p. 97

Corpo e telaio in lamiera d'acciaio pressopiegata verniciata con polveri epossidiche previa fosfatazione. Ottica in policarbonato microprismato a bassa luminanza idonea per ambienti con videoterminali. Sistema di fissaggio ad incasso con staffe regolabili. Sorgente luminosa LED. Emissione diretta. Non idonea per l'applicazione esterna. Alimentazione elettronica CAE. A richiesta: dimmerabile DALI (cod. DL) specificare se con funzione PUSH DIM (cod. PD).

*Bent steel sheet body and frame painted with epoxy powders after phosphating. Low UGR microprismatic polycarbonate diffuser. Recessed fixing system with adjustable brackets. LED light source. Direct light emission. Not suitable for outdoor application. Built in electronic driver CAE. On request: dimmable DALI (code DL) PUSH DIM function (code PD) to be requested.*



### CONTROLLED EB OPAL

p. 98

Corpo e telaio in lamiera d'acciaio pressopiegata verniciata con polveri epossidiche previa fosfatazione. Ottica in policarbonato opale. Sistema di fissaggio ad incasso con staffe regolabili. Sorgente luminosa LED. Emissione diretta. Non idonea per l'applicazione esterna. Alimentazione elettronica CAE. A richiesta: dimmerabile DALI (cod. DL) specificare se con funzione PUSH DIM (cod. PD).

*Bent steel sheet body and frame painted with epoxy powders after phosphating. Opal polycarbonate diffuser. Recessed fixing system with adjustable brackets. LED light source. Direct light emission. Not suitable for outdoor application. Built in electronic driver CAE. On request: dimmable DALI (code DL) PUSH DIM function (code PD) to be requested.*



### CONTROLLED SPA

p. 99

Corpo e telaio in lamiera d'acciaio pressopiegata, verniciata con polveri epossidiche previa fosfatazione. Ottica dark a bassissima luminanza idonea in ambienti con videoterminali (inferiore a 200 cd/mq per angoli superiori a 60° trasversali e longitudinali) parabola in alluminio anodizzato lucido con lastre in policarbonato microprismato. Sistema di fissaggio ad incasso in appoggio in controsoffitti 600x600 mm con struttura portante a vista senza l'utilizzo di accessori, in controsoffitti in cartongesso tramite l'utilizzo del telaio TLC3. Sorgente luminosa LED. Emissione diretta. Non idonea per l'applicazione esterna. Alimentazione elettronica CAE. A richiesta: dimmerabile DALI (cod. DL) specificare se con funzione PUSH DIM (cod. PD).

*Bent steel sheet body and frame painted with epoxy powders after phosphating. Very low UGR dark optic suitable in rooms with VDT (lower than 200 cd/mq for angles >60° transversal and longitudinal), anodized polished aluminum louver with microprismatic polycarbonate steel. Recessed mounting system in 600x600 mm T bar ceilings with visible frame without the use of accessories, in plaster ceilings through the use of the frame TLC3. LED light source. Direct light emission. Not suitable for outdoor application. Built in electronic driver CAE. On request: dimmable DALI (code DL) PUSH DIM function (code PD) to be requested.*



# FOTOMETRIE | PHOTOMETRIES

**INCASSO  
RECESSED**

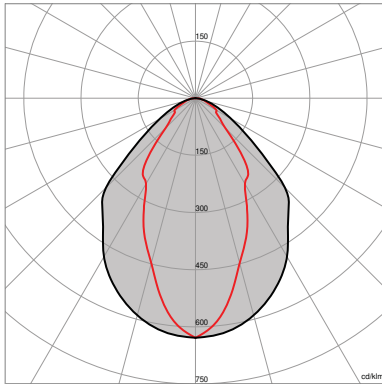

**ALG UP MICRO MP**

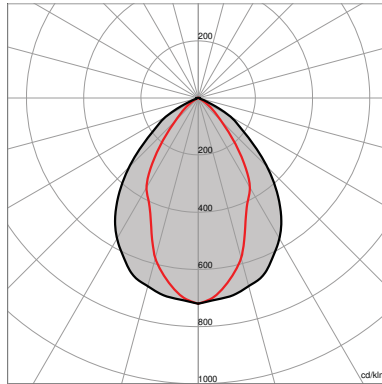

**CONTROLLED EB DARK**

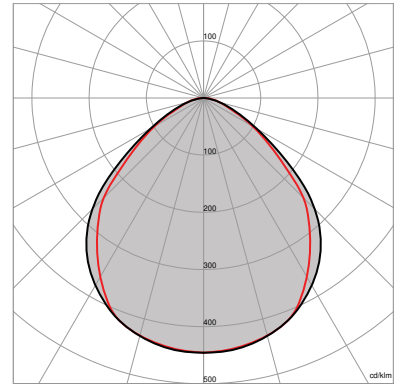

**CONTROLLED EB UGR**

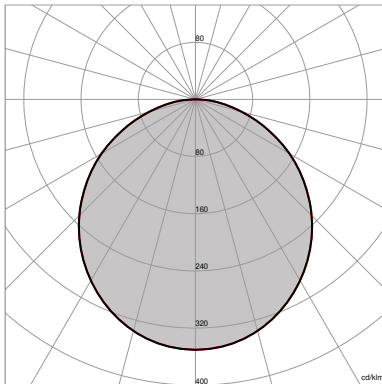

**CONTROLLED EB OPAL**

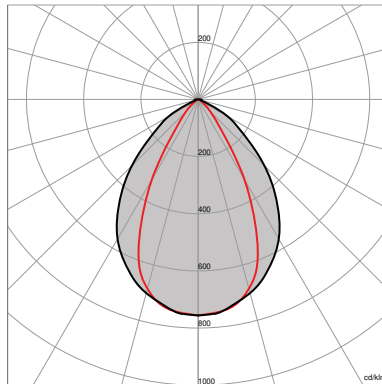

**CONTROLLED EB SPA**



Rimani aggiornato  
Keep up to date

## GAMMA PRODOTTI | PRODUCT RANGE

### INCASSO RECESSED

#### CONTROLLED SPA 2 LUCI

p. 100

Corpo e telaio in lamiera d'acciaio pressopiegata, verniciata con polveri epossidiche previa fosfatazione. Ottica dark a bassissima luminanza idonea in ambienti con videotermini (inferiore a 200 cd/mq per angoli superiori a 60° trasversali e longitudinali) parabola in alluminio anodizzato lucido con lastre in policarbonato microprismato. Sistema di fissaggio ad incasso in appoggio in controsoffitti 600x600 mm con struttura portante a vista senza l'utilizzo di accessori, in controsoffitti in cartongesso tramite l'utilizzo del telaio TLC3. Sorgente luminosa LED. Emissione diretta. Non idonea per l'applicazione esterna. Alimentazione elettronica CAE. A richiesta: dimmerabile DALI (cod. DL) specificare se con funzione PUSH DIM (cod. PD).

*Bent steel sheet body and frame painted with epoxy powders after phosphating. Very low UGR dark optic suitable in rooms with VDT (lower than 200 cd/mq for angles >60° transversal and longitudinal), anodized polished aluminum louver with microprismatic polycarbonate steel. Recessed mounting system in 600x600 mm T bar ceilings with visible frame without the use of accessories, in plaster ceilings through the use of the frame TLC3. LED light source. Direct light emission. Not suitable for outdoor application. Built in electronic driver CAE. On request: dimmable DALI (code DL) PUSH DIM function (code PD) to be requested.*



#### CONTROLLED SPA R

p. 101

Corpo e telaio in lamiera d'acciaio pressopiegata, verniciata con polveri epossidiche previa fosfatazione. Ottica dark a bassissima luminanza idonea in ambienti con videotermini (inferiore a 200 cd/mq per angoli superiori a 60° trasversali e longitudinali) parabola in alluminio anodizzato lucido con lastre in policarbonato microprismato. Sistema di fissaggio ad incasso in appoggio in controsoffitti 600x600 mm con struttura portante a vista senza l'utilizzo di accessori, in controsoffitti in cartongesso tramite l'utilizzo del telaio TLC2. Sorgente luminosa LED. Emissione diretta. Non idonea per l'applicazione esterna. Alimentazione elettronica CAE. A richiesta: dimmerabile DALI (cod. DL) specificare se con funzione PUSH DIM (cod. PD).

*Bent steel sheet body and frame painted with epoxy powders after phosphating. Very low UGR dark optic suitable in rooms with VDT (lower than 200 cd/mq for angles >60° transversal and longitudinal), anodized polished aluminum louver with microprismatic polycarbonate steel. Recessed mounting system in 600x600 mm T bar ceilings with visible frame without the use of accessories, in plaster ceilings through the use of the frame TLC2. LED light source. Direct light emission. Not suitable for outdoor application. Built in electronic driver CAE. On request: dimmable DALI (code DL) PUSH DIM function (code PD) to be requested.*



#### CONTROFLAT LED MP

p. 102

Corpo e telaio in lamiera d'acciaio pressopiegata, verniciata con polveri epossidiche previa fosfatazione. Ottica in policarbonato microprismato con laterali in lamiera d'acciaio verniciato. Sistema di fissaggio ad incasso in appoggio in controsoffitti 600x600 mm con struttura portante a vista senza l'utilizzo di accessori, in controsoffitti in cartongesso tramite l'utilizzo del telaio TLC3. Sorgente luminosa LED. Emissione diretta. Non idonea per l'applicazione esterna. Alimentazione elettronica CAE. A richiesta: dimmerabile DALI (cod. DL) specificare se con funzione PUSH DIM (cod. PD).

*Bent steel sheet body and frame painted with epoxy powders after phosphating. Microprismatic polycarbonate louver with painted sheet steel laterals. Recessed mounting system in 600x600 mm T bar ceilings with visible frame without the use of accessories, in plaster ceilings through the use of the frame TLC3. LED light source. Direct light emission. Not suitable for outdoor application. Built in electronic driver CAE. On request: dimmable DALI (code DL) PUSH DIM function (code PD) to be requested.*



#### MOREFLAT MP

p. 103

Corpo e telaio in lamiera d'acciaio pressopiegata, verniciata con polveri epossidiche previa fosfatazione. Ottica in policarbonato microprismato con laterali in lamiera d'acciaio verniciato. Sistema di fissaggio ad incasso in appoggio in controsoffitti 600x600 mm con struttura portante a vista senza l'utilizzo di accessori, in controsoffitti in cartongesso tramite l'utilizzo del telaio TLC3. Sorgente luminosa LED. Emissione diretta. Non idonea per l'applicazione esterna. Alimentazione elettronica CAE. A richiesta: dimmerabile DALI (cod. DL) specificare se con funzione PUSH DIM (cod. PD).

*Bent steel sheet body and frame painted with epoxy powders after phosphating. Microprismatic polycarbonate louver with painted sheet steel laterals. Recessed mounting system in 600x600 mm T bar ceilings with visible frame without the use of accessories, in plaster ceilings through the use of the frame TLC3. LED light source. Direct light emission. Not suitable for outdoor application. Built in electronic driver CAE. On request: dimmable DALI (code DL) PUSH DIM function (code PD) to be requested.*



#### CONTROPLUS UGR

p. 104

Corpo e telaio non apribile in lamiera d'acciaio pressopiegata, verniciata con polveri epossidiche previa fosfatazione. Ottica in policarbonato microprismato a bassa luminanza idonea in ambienti con videotermini (inferiore a 1000 cd/mq per angoli superiori a 65° trasversali e longitudinali). Sistema di fissaggio ad incasso in appoggio in controsoffitti 600x600 mm con struttura portante a vista senza l'utilizzo di accessori, in controsoffitti in cartongesso tramite l'utilizzo del telaio TLC3 o TLC4. Sorgente luminosa LED. Emissione diretta. Non idonea per l'applicazione esterna. Alimentazione elettronica CAE. A richiesta: dimmerabile DALI (cod. DL) specificare se con funzione PUSH DIM (cod. PD).

*Bent steel sheet unopenable body and frame painted with epoxy powders after phosphating. Low UGR microprismatic polycarbonate louver suitable in rooms with VDT (lower than 1000 cd/mq for angles >65° transversal and longitudinal). Recessed mounting system in 600x600 mm T bar ceilings with visible frame without the use of accessories, in plaster ceilings through the use of the frame TLC3 or TLC4. LED light source. Direct light emission. Not suitable for outdoor application. Built in electronic driver CAE. On request: dimmable DALI (code DL) PUSH DIM function (code PD) to be requested.*





# FOTOMETRIE | PHOTOMETRIES

**INCASSO**  
RECESSED

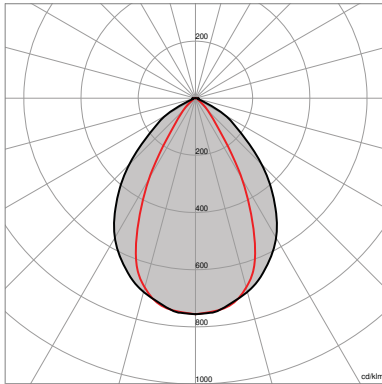

**CONTROLLED SPA 2 LUCI**

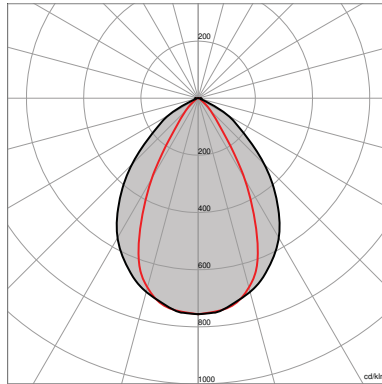

**CONTROLLED SPA R**

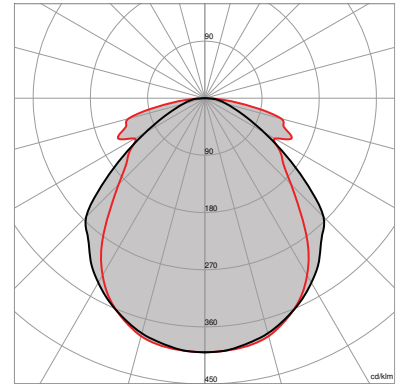

**CONTROFLAT LED MP**

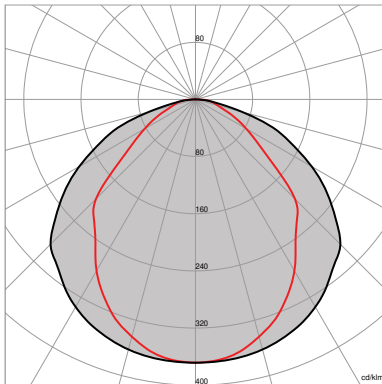

**MOREFLAT MP**

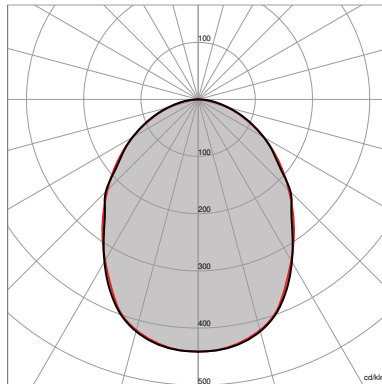

**CONTROPLUS UGR**



Rimani aggiornato  
Keep up to date

# GAMMA PRODOTTI | PRODUCT RANGE

## INCASSO RECESSED

### CONTROPLUS OPAL

p. 105

Corpo e telaio non apribile in lamiera d'acciaio pressopiegata, verniciata con polveri epossidiche previa fosfatazione. Ottica in policarbonato opale. Sistema di fissaggio ad incasso in appoggio in controsoffitti 600x600 mm con struttura portante a vista senza l'utilizzo di accessori, in controsoffitti in cartogesso tramite l'utilizzo del telaio TLC3 o TLC4. Sorgente luminosa LED. Emissione diretta. Non idonea per l'applicazione esterna. Alimentazione elettronica CAE. A richiesta: dimmerabile DALI (cod. DL) specificare se con funzione PUSH DIM (cod. PD).

*Bent steel sheet unopenable body and frame painted with epoxy powders after phosphating. Opal polycarbonate louver. Recessed mounting system in 600x600 mm T bar ceilings with visible frame without the use of accessories, in plaster ceilings through the use of the frame TLC3 or TLC4. LED light source. Direct light emission. Not suitable for outdoor application. Built in electronic driver CAE. On request: dimmable DALI (code DL) PUSH DIM function (code PD) to be requested.*



### CONTROPLUS R UGR

p. 107

Corpo e telaio non apribile in lamiera d'acciaio pressopiegata, verniciata con polveri epossidiche previa fosfatazione. Ottica in policarbonato microprismato a bassa luminanza idonea in ambienti con videotermini (inferiore a 1000 cd/mq per angoli superiori a 65° trasversali e longitudinali). Sistema di fissaggio ad incasso in appoggio in controsoffitti 600x600 mm con struttura portante a vista senza l'utilizzo di accessori, in controsoffitti in cartogesso tramite l'utilizzo del telaio TLC1 o TLC2. Sorgente luminosa LED. Emissione diretta. Non idonea per l'applicazione esterna. Alimentazione elettronica CAE. A richiesta: dimmerabile DALI (cod. DL) specificare se con funzione PUSH DIM (cod. PD).

*Bent steel sheet unopenable body and frame painted with epoxy powders after phosphating. Low UGR microprismatic polycarbonate louver suitable in rooms with VDT (lower than 1000 cd/mq for angles >65° transversal and longitudinal). Recessed mounting system in 600x600 mm T bar ceilings with visible frame without the use of accessories, in plaster ceilings through the use of the frame TLC1 or TLC2. LED light source. Direct light emission. Not suitable for outdoor application. Built in electronic driver CAE. On request: dimmable DALI (code DL) PUSH DIM function (code PD) to be requested.*



### CONTROPLUS R OPAL

p. 108

Corpo e telaio non apribile in lamiera d'acciaio pressopiegata, verniciata con polveri epossidiche previa fosfatazione. Ottica in policarbonato opale. Sistema di fissaggio ad incasso in appoggio in controsoffitti 600x600 mm con struttura portante a vista senza l'utilizzo di accessori, in controsoffitti in cartogesso tramite l'utilizzo del telaio TLC1 o TLC2. Sorgente luminosa LED. Emissione diretta. Non idonea per l'applicazione esterna. Alimentazione elettronica CAE. A richiesta: dimmerabile DALI (cod. DL) specificare se con funzione PUSH DIM (cod. PD).

*Bent steel sheet unopenable body and frame painted with epoxy powders after phosphating. Opal polycarbonate louver. Recessed mounting system in 600x600 mm T bar ceilings with visible frame without the use of accessories, in plaster ceilings through the use of the frame TLC1 or TLC2. LED light source. Direct light emission. Not suitable for outdoor application. Built in electronic driver CAE. On request: dimmable DALI (code DL) PUSH DIM function (code PD) to be requested.*



### COMPATTA UGR

p. 109

Corpo non apribile in lamiera d'acciaio pressopiegata, verniciata con polveri epossidiche previa fosfatazione. Ottica in PMMA microprismato a bassa luminanza idonea in ambienti con videotermini (inferiore a 1000 cd/mq per angoli superiori a 65° trasversali e longitudinali). Sistemi di fissaggio ad incasso in appoggio in controsoffitti 600x600 mm con struttura portante a vista senza l'utilizzo di accessori, in controsoffitti in cartogesso tramite l'utilizzo del telaio TLC3. Sorgente luminosa LED. Emissione diretta. Non idonea per l'applicazione esterna. Alimentazione elettronica CAE. A richiesta: dimmerabile DALI (cod. DL) specificare se con funzione PUSH DIM (cod. PD).

*Bent steel sheet unopenable body and frame painted with epoxy powders after phosphating. Low UGR PMMA microprismatic louver suitable in rooms with VDT (lower than 1000 cd/mq for angles >65° transversal and longitudinal). Recessed mounting system in 600x600 mm T bar ceilings with visible frame without the use of accessories, in plaster ceilings through the use of the frame TLC3. LED light source. Direct light emission. Not suitable for outdoor application. Built in electronic driver CAE. On request: dimmable DALI (code DL) PUSH DIM function (code PD) to be requested.*



### CONTRO CLIP-IN UGR

p. 110

Corpo e telaio non apribile in lamiera d'acciaio pressopiegata, verniciata con polveri epossidiche previa fosfatazione. Ottica in policarbonato microprismato a bassa luminanza idonea in ambienti con videotermini (inferiore a 1000 cd/mq per angoli superiori a 65° trasversali e longitudinali). Sistema di fissaggio tipo clip-in con staffe regolabili. **Regolazione staffe dai pannelli adiacenti.** Sorgente luminosa LED. Emissione diretta. Non idonea per l'applicazione esterna. Alimentazione elettronica CAE. A richiesta: dimmerabile DALI (cod. DL) specificare se con funzione PUSH DIM (cod. PD).

*Bent steel sheet unopenable body and frame painted with epoxy powders after phosphating. Low UGR microprismatic polycarbonate louver suitable in rooms with VDT (lower than 1000 cd/mq for angles >65° transversal and longitudinal). Recessed mounting CLIP-IN with adjustable brackets. **Bracket adjustment from the closer panels.** LED light source. Direct light emission. Not suitable for outdoor application. Built in electronic driver CAE. On request: dimmable DALI (code DL) PUSH DIM function (code PD) to be requested.*



# FOTOMETRIE | PHOTOMETRIES

**INCASSO**  
RECESSED

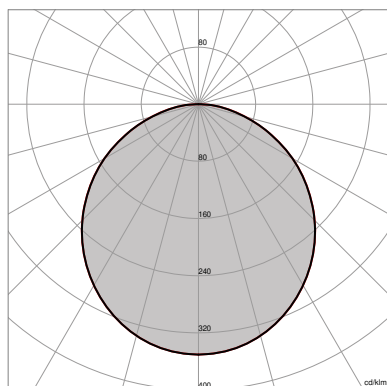

**CONTROPLUS OPAL**

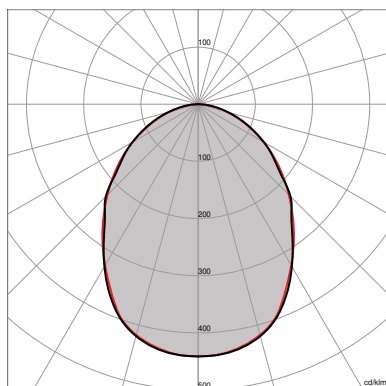

**CONTROPLUS R UGR**

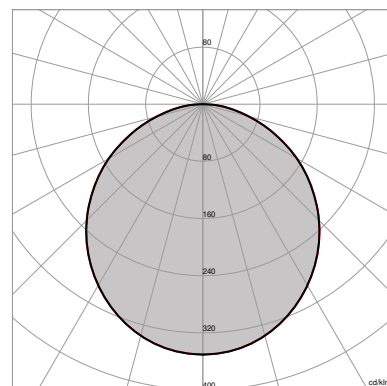

**CONTROPLUS R OPAL**

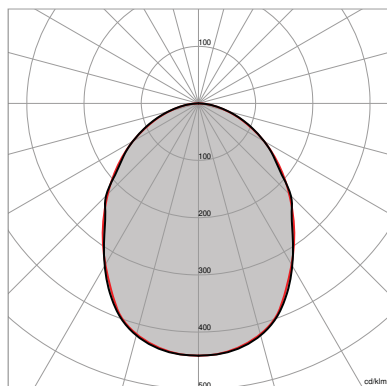

**COMPATTA UGR**

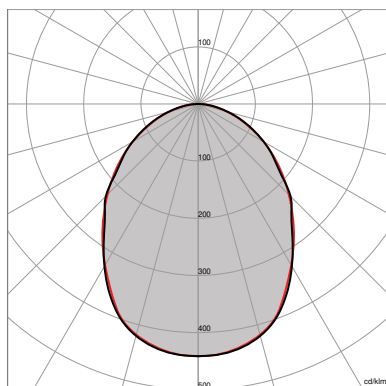

**CONTROL-CLIP-IN UGR**



Rimani aggiornato  
Keep up to date

# GAMMA PRODOTTI | PRODUCT RANGE

## INCASSO RECESSED

### ADRIAN

p. 112



Corpo in lamiera d'alluminio e telaio in alluminio estruso, verniciato con polveri epossidiche previa fosfatazione. Schermo di chiusura in PMMA opale. Sistema d'installazione ad incasso in appoggio in controsoffitti 600x600mm con struttura portante a vista senza l'utilizzo di accessori, in controsoffitti in cartongesso tramite l'utilizzo del telaio TLC3. Sorgente luminosa LED. Emissione diretta.

*Aluminum sheet body and extruded aluminum frame, painting with epoxy powders after phosphating. PMMA Opal reflector. Recessed installation system lay on false ceiling 600x600mm with visible holding structure without using accessories, in plasterboard false ceilings by using the TLC3 frame, LED light source. Direct emission.*

### ADRIAN UGR

p. 112



Corpo in lamiera d'alluminio e telaio in alluminio estruso, verniciato con polveri epossidiche previa fosfatazione. Schermo di chiusura in PMMA prismatico, idoneo per ambienti con videotermini. Sistema d'installazione ad incasso in appoggio in controsoffitti 600x600mm con struttura portante a vista senza l'utilizzo di accessori, in controsoffitti in cartongesso tramite l'utilizzo del telaio TLC3. Sorgente luminosa LED. Emissione diretta.

*Aluminum sheet body and extruded aluminum frame, painting with epoxy powders after phosphating. PMMA prismatic, suitable in rooms with VDT. Recessed installation system lay on false ceiling 600x600mm with visible holding structure without using accessories, in plasterboard false ceilings by using the TLC3 frame, LED light source. Direct emission.*

### TELAI | FRAMES

p. 111

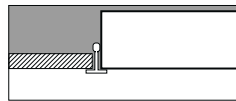

Telai in lamiera d'acciaio pressopiegata e verniciata con polveri epossidiche previa fosfatazione per soffitti chiusi. Staffe regolabili in acciaio zincato incluse. Idonei per l'installazione di tutti i prodotti IDEALLUX da incasso in soffitti in cartongesso.

*Bent steel sheet frames painted with epoxy powders after phosphating for closed false ceiling. Zinc coated steel adjustable brackets included. Suitable for the installation of all the IDEALLUX products in false ceiling.*

# FOTOMETRIE | PHOTOMETRIES

**INCASSO**  
RECESSED

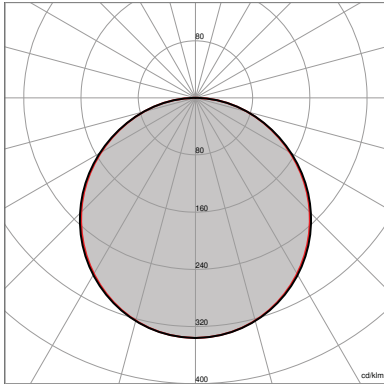

**ADRIAN**

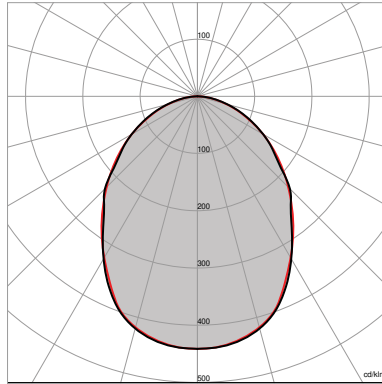

**ADRIAN UGR**



Rimani aggiornato  
*Keep up to date*

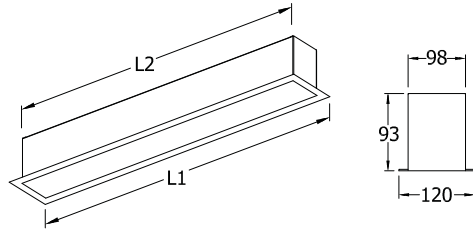

[L] Lunghezze disponibili | Available lengths:  
786 mm - 1161 mm - 1536 mm

Foro incasso/Cut out :  
L 786 mm - 770x105 mm  
L 1161 mm - 1145x105 mm  
L 1536 mm - 1520x105 mm

# ALG UP OP

Apparecchio LED per montaggio ad incasso. Schermo opale.

**A richiesta:** versione speciale per fila continua.

*LED lighting fitting for recessed mounting. Opal diffuser.*

**On request:** special version for continuous line application.

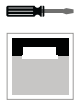

**A RICHIESTA | ON REQUEST**

<b>5Y WARRANTY</b> 5% FAILURE RATE	<b>60.000 h</b> LED LIFETIME L90B10	<b>100.000 h</b> LED LIFETIME L70B50
---------------------------------------	--	---

>90 CRI	EM EN 60910-2-22	DL DALI	PD PUSH DIM
------------	---------------------	------------	----------------

Relamping	Lumen LED*	Watt LED**	Lumen Out***	Watt	Lumen Watt Out	L Lunghezza L Length	Configurazione LED LED configuration	Code Code	K	Alimentazione Power Supply	Colore Colour
1x36	<b>4100</b>	20	2365	21,5	> 110	L1 786 mm L2 762 mm	_____	<b>AGLO5020</b>	W: 3.000 N: 4.000	— : CAE A RICHIESTA   ON REQUEST DL: DALI PD: PUSH DIM	<b>01:</b> bianco white
1x36	<b>4940</b>	25	2592	26,5	> 98	L1 786 mm L2 762 mm	_____	<b>AGLO5029</b>	W: 3.000 N: 4.000	— : CAE A RICHIESTA   ON REQUEST DL: DALI PD: PUSH DIM	<b>01:</b> bianco white
1x58	<b>6300</b>	30	3598	32,5	> 110	L1 1161 mm L2 1137 mm	_____	<b>AGLO5030</b>	W: 3.000 N: 4.000	— : CAE A RICHIESTA   ON REQUEST DL: DALI PD: PUSH DIM	<b>01:</b> bianco white
1x58	<b>7380</b>	36,5	3838	39	> 98	L1 1161 mm L2 1137 mm	_____	<b>AGLO5042</b>	W: 3.000 N: 4.000	— : CAE A RICHIESTA   ON REQUEST DL: DALI PD: PUSH DIM	<b>01:</b> bianco white
2x36	<b>8400</b>	40	4675	42,5	> 110	L1 1536 mm L2 1512 mm	_____	<b>AGLO5039</b>	W: 3.000 N: 4.000	— : CAE A RICHIESTA   ON REQUEST DL: DALI PD: PUSH DIM	<b>01:</b> bianco white
2x36	<b>9870</b>	49	5096	52	> 98	L1 1536 mm L2 1512 mm	_____	<b>AGLO5057</b>	W: 3.000 N: 4.000	— : CAE A RICHIESTA   ON REQUEST DL: DALI PD: PUSH DIM	<b>01:</b> bianco white

CE	EN 60529	>80 CRI	IP43 EN 60529	230 V 2014/35/UE	50/60 Hz	IK 07 EN 60668
850° EN 60695	A++ A+ A	RG 0 EN 62471	01 WHITE	SELV		

TEMPERATURA AMBIENTE MIN E MAX | MIN AND MAX ROOM TEMPERATURE: (-10° +40°)

\* Lumen nominali LED max a 25° | Nominal lumen at max 25°

\*\* Potenza dei LED | LED power

\*\*\* Flusso totale in uscita dall'apparecchio a temperatura di lavoro (Ta 25° - 4.000 K) | Total lighting fitting flux output at working temperature (Ta 25° - 4.000 K) | (3.000 K -8% - CRI 90 -10%)

\*\*\*\* Schema di cablaggio (vedi pagina 361) | Connection scheme (see page 361)



Fotometrie | Photometries  
p. 81



Schema di cablaggio | Connection scheme  
p. XXVIII-XXIX



Descrizione prodotto | Product description  
p. 80

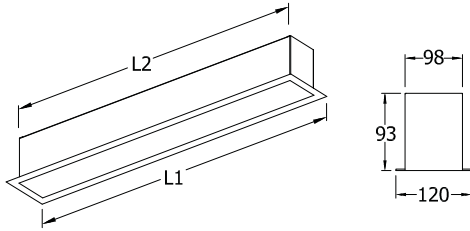

**[L]** Lunghezze disponibili | Available lengths:  
**786 mm - 1161 mm - 1536 mm**

Foro incasso/Cut out :  
**L 786 mm - 770x105 mm**  
**L 1161 mm - 1145x105 mm**  
**L 1536 mm - 1520x105 mm**



# ALG UP MP

Apparecchio LED per montaggio ad incasso. Schermo microprismatico.  
**A richiesta:** versione speciale per fila continua.  
*LED lighting fitting for recessed mounting. Microprismatic diffuser.*  
**On request:** special version for continuous line application.

**A RICHIESTA | ON REQUEST**

>90  
CRI

EM  
EN 60598-2-22

DL  
DALI

PD  
PUSH DIM

**5Y WARRANTY**  
5% FAILURE RATE

**60.000 h**  
LED LIFETIME L90B10

**100.000 h**  
LED LIFETIME L70B50

Relamping	Lumen LED*	Watt LED**	Lumen Out***	Watt	Lumen Watt Out	L Lunghezza L Length	Configurazione LED LED configuration	Code Code	K	Alimentazione Power Supply	Colore Colour
1x58	<b>4100</b>	20	2800	21,5	> 130	L1 786 mm L2 762 mm	_____	<b>AGLMP5020</b>	W: 3.000	— : CAE A RICHIESTA   ON RE-QUEST	<b>01:</b> bianco white
1x58	<b>4940</b>	25	3153	26,5	> 119	L1 786 mm L2 762 mm	_____	<b>AGLMP5029</b>	N: 4.000	DL: DALI PD: PUSH DIM	
2x36	<b>6300</b>	30	4225	32,5	> 130	L1 1161 mm L2 1137 mm	_____	<b>AGLMP5030</b>	W: 3.000	— : CAE A RICHIESTA   ON RE-QUEST	<b>01:</b> bianco white
2x36	<b>7360</b>	36,5	4641	39	> 119	L1 1161 mm L2 1137 mm	_____	<b>AGLMP5042</b>	N: 4.000	DL: DALI PD: PUSH DIM	
2x58	<b>8400</b>	40	5551	42,5	> 130	L1 1536 mm L2 1512 mm	_____	<b>AGLMP5039</b>	W: 3.000	— : CAE A RICHIESTA   ON RE-QUEST	<b>01:</b> bianco white
2x58	<b>9880</b>	49	6190	52	> 119	L1 1536 mm L2 1512 mm	_____	<b>AGLMP5057</b>	N: 4.000	DL: DALI PD: PUSH DIM	

CE

>80  
CRI

IP43  
EN 60529

230 V  
2014/35/UE

50/60  
Hz

IK 07  
EN 60068

850°  
EN 60695

A++  
A+

RG 0  
EN 62471

01  
WHITE

SELV

19  
UGR

TEMPERATURA AMBIENTE MIN E MAX | MIN AND MAX ROOM TEMPERATURE: **(-10° +40°)**

\* Lumen nominali LED max a 25° | Nominal lumen at max 25°

\*\* Potenza dei LED | LED power

\*\*\* Flusso totale in uscita dall'apparecchio a temperatura di lavoro (Ta 25° - 4.000 K) | Total lighting fitting flux output at working temperature (Ta 25° - 4.000 K) | (3.000 K -8% - CRI 90 -10%)



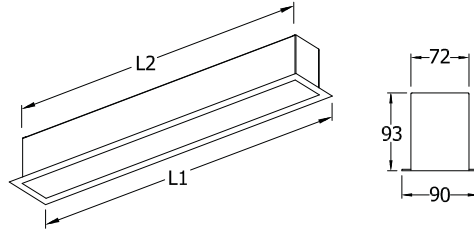
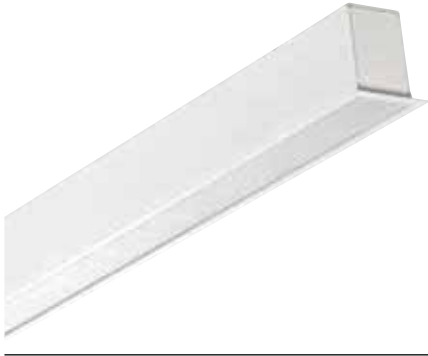

**[L]** Lunghezze disponibili | Available lengths:  
**786 mm - 1161 mm - 1536 mm**

Foro incasso/Cut out :  
**L 786 mm - 770x80 mm**  
**L 1161 mm - 1145x80 mm**  
**L 1536 mm - 1520x80 mm**

# ALG UP SMALL OP

Apparecchio LED per montaggio ad incasso. Schermo opale.

**A richiesta:** versione speciale per fila continua.

**LED lighting fitting for recessed mounting. Opal diffuser.**

**On request: special version for continuous line application.**



**A RICHIESTA | ON REQUEST**

<b>5Y WARRANTY</b> 5% FAILURE RATE	<b>60.000 h</b> LED LIFETIME <b>L90B10</b>	<b>100.000 h</b> LED LIFETIME <b>L70B50</b>
---------------------------------------	---	--

<b>&gt;90</b> CRI	<b>EM</b> EN 60910-2-22	<b>DL</b> DALI	<b>PD</b> PUSH DIM
----------------------	----------------------------	-------------------	-----------------------

Relamping	Lumen LED*	Watt LED**	Lumen Out***	Watt	Lumen Watt Out	L Lunghezza L Length	Configurazione LED LED configuration	Codice Code	K	Alimentazione Power Supply	Colore Colour
1X18	<b>2050</b>	10	1190	11	> 108	<b>L1</b> 786 mm <b>L2</b> 762 mm	_____	<b>ASMO5010</b>	<b>W:</b> 3.000	— : CAE A RICHIESTA   ON REQUEST	<b>01:</b> bianco white
1X18	<b>2870</b>	15	1580	16,6	> 96	<b>L1</b> 786 mm <b>L2</b> 762 mm	_____	<b>ASMO5014</b>	<b>N:</b> 4.000	<b>DL:</b> DALI <b>PD:</b> PUSH DIM	
1X24	<b>3075</b>	15,5	1782	16	> 108	<b>L1</b> 1161 mm <b>L2</b> 1137 mm	_____	<b>ASMO5015</b>	<b>W:</b> 3.000	— : CAE A RICHIESTA   ON REQUEST	<b>01:</b> bianco white
1X24	<b>4300</b>	23,4	2400	25	> 96	<b>L1</b> 1161 mm <b>L2</b> 1137 mm	_____	<b>ASMO5021</b>	<b>N:</b> 4.000	<b>DL:</b> DALI <b>PD:</b> PUSH DIM	
1X35	<b>4100</b>	20,5	2376	24	> 108	<b>L1</b> 1536 mm <b>L2</b> 1512 mm	_____	<b>ASMO5050</b>	<b>W:</b> 3.000	— : CAE A RICHIESTA   ON REQUEST	<b>01:</b> bianco white
1X35	<b>5730</b>	31	3170	33	> 96	<b>L1</b> 1536 mm <b>L2</b> 1512 mm	_____	<b>ASMO5029</b>	<b>N:</b> 4.000	<b>DL:</b> DALI <b>PD:</b> PUSH DIM	

<b>CE</b>		<b>&gt;80</b> CRI	<b>IP43</b> EN 60529	<b>230 V</b> 2014/35/UE	<b>50/60</b> Hz	<b>IK 07</b> EN 60668
<b>850°</b> EN 60695	<b>A++</b> A+ A	<b>RG 0</b> EN 62471		<b>01</b> WHITE	<b>SELV</b>	

TEMPERATURA AMBIENTE MIN E MAX | MIN AND MAX ROOM TEMPERATURE: **(-10° +40°)**

\* Lumen nominali LED max a 25° | Nominal lumen at max 25°

\*\* Potenza dei LED | LED power

\*\*\* Flusso totale in uscita dall'apparecchio a temperatura di lavoro (Ta 25° - 4.000 K) | Total lighting fitting flux output at working temperature (Ta 25° - 4.000 K) | (3.000 K -8% - CRI 90 -10%)



Fotometrie | Photometries  
p. 81



Schema di cablaggio | Connection scheme  
p. XXVIII-XXIX



Descrizione prodotto | Product description  
p. 80

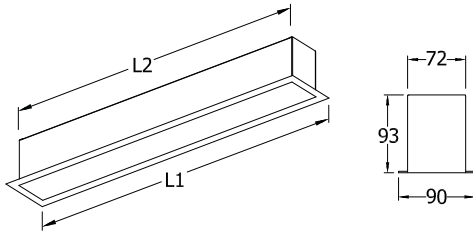

**[L]** Lunghezze disponibili | Available lengths:  
**786 mm - 1161 mm - 1536 mm**

Foro incasso/Cut out :  
**L 786 mm - 765x75 mm**  
**L 1161 mm - 1140x75 mm**  
**L 1536 mm - 1515x75 mm**



# ALG UP SMALL MP

Apparecchio LED per montaggio ad incasso. Schermo microprismatico.  
**A richiesta:** versione speciale per fila continua.  
*LED lighting fitting for recessed mounting. Microprismatic diffuser.*  
**On request:** special version for continuous line application.

**A RICHIESTA | ON REQUEST**

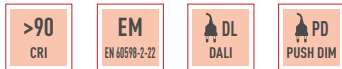

Relamping	Lumen LED*	Watt LED**	Lumen Out***	Watt	Lumen Watt Out	L Lunghezza L Length	Configurazione LED LED configuration	Code Code	K	Alimentazione Power Supply	Colore Colour
1x24	<b>2050</b>	10	1354	11	> 123	<b>L1</b> 786 mm <b>L2</b> 762 mm	_____	<b>ASMMP5010</b>	<b>W:</b> 3.000 <b>N:</b> 4.000	— : CAE A RICHIESTA   ON REQUEST <b>DL:</b> DALI <b>PD:</b> PUSH DIM	<b>01:</b> bianco white
1x24	<b>2870</b>	15,5	1895	16,5	> 115	<b>L1</b> 786 mm <b>L2</b> 762 mm	_____	<b>ASMMP5014</b>	<b>W:</b> 3.000 <b>N:</b> 4.000	— : CAE A RICHIESTA   ON REQUEST <b>DL:</b> DALI <b>PD:</b> PUSH DIM	<b>01:</b> bianco white
1x28	<b>3075</b>	15,5	2030	16,5	> 123	<b>L1</b> 1161 mm <b>L2</b> 1137 mm	_____	<b>ASMMP5015</b>	<b>W:</b> 3.000 <b>N:</b> 4.000	— : CAE A RICHIESTA   ON REQUEST <b>DL:</b> DALI <b>PD:</b> PUSH DIM	<b>01:</b> bianco white
1x36	<b>4300</b>	23,5	2875	25	> 115	<b>L1</b> 1161 mm <b>L2</b> 1137 mm	_____	<b>ASMMP5021</b>	<b>W:</b> 3.000 <b>N:</b> 4.000	— : CAE A RICHIESTA   ON REQUEST <b>DL:</b> DALI <b>PD:</b> PUSH DIM	<b>01:</b> bianco white
1x35	<b>4100</b>	20,5	2576	24	> 108	<b>L1</b> 1536 mm <b>L2</b> 1512 mm	_____	<b>ASMMP5050</b>	<b>W:</b> 3.000 <b>N:</b> 4.000	— : CAE A RICHIESTA   ON REQUEST <b>DL:</b> DALI <b>PD:</b> PUSH DIM	<b>01:</b> bianco white
1x58	<b>5730</b>	31	3795	33	> 115	<b>L1</b> 1536 mm <b>L2</b> 1512 mm	_____	<b>ASMMP5029</b>	<b>W:</b> 3.000 <b>N:</b> 4.000	— : CAE A RICHIESTA   ON REQUEST <b>DL:</b> DALI <b>PD:</b> PUSH DIM	<b>01:</b> bianco white



TEMPERATURA AMBIENTE MIN E MAX | MIN AND MAX ROOM TEMPERATURE: **(-10° +40°)**

\* Lumen nominali LED max a 25° | Nominal lumen at max 25°

\*\* Potenza dei LED | LED power

\*\*\* Flusso totale in uscita dall'apparecchio a temperatura di lavoro (Ta 25° - 4.000 K) | Total lighting fitting flux output at working temperature (Ta 25° - 4.000 K) | (3.000 K -8% - CRI 90 -10%)



Descrizione prodotto | Product description  
 p. 80



Schema di cablaggio | Connection scheme  
 p. XXVIII-XXIX



Fotometrie | Photometries  
 p. 81

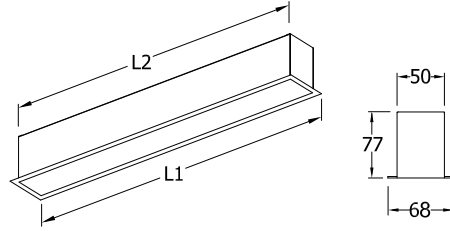

**[L]** Lunghezze disponibili | Available lengths:  
786 mm - 1161 mm - 1536 mm

Foro incasso/Cut out :  
L 786 mm - 765x54 mm  
L 1161 mm - 1140x54 mm  
L 1536 mm - 1515x54 mm

# ALG UP MICRO OP

Apparecchio LED per montaggio ad incasso. Schermo opale.

**A richiesta:** versione speciale per fila continua.

**LED lighting fitting for recessed mounting. Opal diffuser.**

**On request: special version for continuous line application.**



**A RICHIESTA | ON REQUEST**

<b>5Y WARRANTY</b> 5% FAILURE RATE	<b>60.000 h</b> LED LIFETIME L90B10	<b>100.000 h</b> LED LIFETIME L70B50
---------------------------------------	--	---

<b>&gt;90</b> CRI	<b>EM</b> EN 60910-2-22	<b>DL</b> DALI	<b>PD</b> PUSH DIM
----------------------	----------------------------	-------------------	-----------------------

Relamping	Lumen LED*	Watt LED**	Lumen Out***	Watt	Lumen Watt Out	L Lunghezza L Length	Configurazione LED LED configuration	Codice Code	K	Alimentazione Power Supply	Colore Colour
1x18	<b>2050</b>	10	1190	11	> 108	L1 786 mm L2 762 mm	_____	<b>AMCO5010</b>	W: 3.000	— : CAE A RICHIESTA   ON REQUEST	<b>01:</b> bianco white
1x18	<b>2870</b>	15,5	1580	16,5	> 96	L1 786 mm L2 762 mm	_____	<b>AMCO5014</b>	N: 4.000	DL: DALI PD: PUSH DIM	
1x24	<b>3075</b>	15,5	1732	16,5	> 108	L1 1161 mm L2 1137 mm	_____	<b>AMCO5015</b>	W: 3.000	— : CAE A RICHIESTA   ON REQUEST	<b>01:</b> bianco white
1x24	<b>4300</b>	23,5	2400	25	> 96	L1 1161 mm L2 1137 mm	_____	<b>AMCO5021</b>	N: 4.000	DL: DALI PD: PUSH DIM	
1x35	<b>4100</b>	20,5	2376	24	> 108	L1 1536 mm L2 1512 mm	_____	<b>AMCO5050</b>	W: 3.000	— : CAE A RICHIESTA   ON REQUEST	<b>01:</b> bianco white
1x35	<b>5730</b>	31	3170	33	> 96	L1 1536 mm L2 1512 mm	_____	<b>AMCO5029</b>	N: 4.000	DL: DALI PD: PUSH DIM	

<b>CE</b>		<b>&gt;80</b> CRI	<b>IP43</b> EN 60529	<b>230 V</b> 2014/35/UE	<b>50/60</b> Hz	<b>IK 07</b> EN 60068
<b>850°</b> EN 60695	<b>A++</b> A+	<b>RG 0</b> EN 62471		<b>01</b> WHITE	<b>SELV</b>	

TEMPERATURA AMBIENTE MIN E MAX | MIN AND MAX ROOM TEMPERATURE: (-10° +40°)

\* Lumen nominali LED max a 25° | Nominal lumen at max 25°

\*\* Potenza dei LED | LED power

\*\*\* Flusso totale in uscita dall'apparecchio a temperatura di lavoro (Ta 25° - 4.000 K) | Total lighting fitting flux output at working temperature (Ta 25° - 4.000 K) | (3.000 K -8% - CRI 90 -10%)



Fotometrie | Photometries  
p. 81



Schema di cablaggio | Connection scheme  
p. XXVIII-XXIX



Descrizione prodotto | Product description  
p. 80

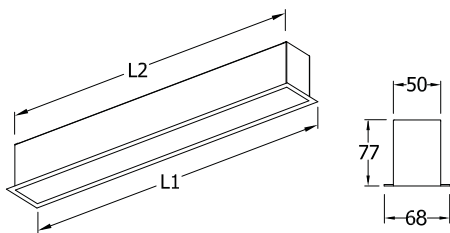

**[L]** Lunghezze disponibili | Available lengths:  
**786 mm - 1161 mm - 1536 mm**

Foro incasso/Cut out :  
**L 786 mm** - 765x54 mm  
**L 1161 mm** - 1140x54 mm  
**L 1536 mm** - 1515x54 mm



**A RICHIESTA | ON REQUEST**



# ALG UP MICRO MP

Apparecchio LED per montaggio ad incasso. Schermo microprismatico.  
**A richiesta:** versione speciale per fila continua.  
*LED lighting fitting for recessed mounting. Microprismatic diffuser.*  
**On request:** special version for continuous line application.

<b>5Y WARRANTY</b> 5% FAILURE RATE	<b>60.000 h</b> LED LIFETIME <b>L90B10</b>	<b>100.000 h</b> LED LIFETIME <b>L70B50</b>
---------------------------------------	---	--

Relamping	Lumen LED*	Watt LED**	Lumen Out***	Watt	Lumen Watt Out	L Lunghezza L Length	Configurazione LED LED configuration	Code Code	K	Alimentazione Power Supply	Colore Colour
1x24	<b>2050</b>	10	1354	11	> 123	<b>L1</b> 786 mm <b>L2</b> 762 mm	_____	<b>AMCMP5010</b>	<b>W:</b> 3.000 <b>N:</b> 4.000	— : CAE A RICHIESTA   ON REQUEST <b>DL:</b> DALI <b>PD:</b> PUSH DIM	<b>01:</b> bianco white
1x24	<b>2870</b>	15,5	1895	16,5	> 115	<b>L1</b> 786 mm <b>L2</b> 762 mm	_____	<b>AMCMP5014</b>	<b>W:</b> 3.000 <b>N:</b> 4.000	— : CAE A RICHIESTA   ON REQUEST <b>DL:</b> DALI <b>PD:</b> PUSH DIM	<b>01:</b> bianco white
1x28	<b>3075</b>	15,5	2030	16,5	> 123	<b>L1</b> 1161 mm <b>L2</b> 1137 mm	_____	<b>AMCMP5015</b>	<b>W:</b> 3.000 <b>N:</b> 4.000	— : CAE A RICHIESTA   ON REQUEST <b>DL:</b> DALI <b>PD:</b> PUSH DIM	<b>01:</b> bianco white
1x36	<b>4300</b>	23,5	2875	25	> 115	<b>L1</b> 1161 mm <b>L2</b> 1137 mm	_____	<b>AMCMP5021</b>	<b>W:</b> 3.000 <b>N:</b> 4.000	— : CAE A RICHIESTA   ON REQUEST <b>DL:</b> DALI <b>PD:</b> PUSH DIM	<b>01:</b> bianco white
1x35	<b>4100</b>	20,5	2576	24	> 123	<b>L1</b> 1536 mm <b>L2</b> 1512 mm	_____	<b>AMCMP5050</b>	<b>W:</b> 3.000 <b>N:</b> 4.000	— : CAE A RICHIESTA   ON REQUEST <b>DL:</b> DALI <b>PD:</b> PUSH DIM	<b>01:</b> bianco white
1x35	<b>5730</b>	31	3795	33	> 115	<b>L1</b> 1536 mm <b>L2</b> 1512 mm	_____	<b>AMCMP5029</b>	<b>W:</b> 3.000 <b>N:</b> 4.000	— : CAE A RICHIESTA   ON REQUEST <b>DL:</b> DALI <b>PD:</b> PUSH DIM	<b>01:</b> bianco white

<b>CE</b>		<b>&gt;80</b> CRI	<b>IP43</b> EN 60529	<b>230 V</b> 2014/35/UE	<b>50/60</b> Hz	<b>IK 07</b> EN 60068
<b>850°</b> EN 60695	<b>A++</b> A+	<b>RG 0</b> EN 62471		<b>01</b> WHITE	<b>SELV</b>	<b>19</b> UGR

TEMPERATURA AMBIENTE MIN E MAX | MIN AND MAX ROOM TEMPERATURE: **(-10° +40°)**

\* Lumen nominali LED max a 25° | Nominal lumen at max 25°

\*\* Potenza dei LED | LED power

\*\*\* Flusso totale in uscita dall'apparecchio a temperatura di lavoro (Ta 25° - 4.000 K) | Total lighting fitting flux output at working temperature (Ta 25° - 4.000 K) | (3.000 K -8% - CRI 90 -10%)



Descrizione prodotto | Product description  
 p. 82



Schema di cablaggio | Connection scheme  
 p. XXVIII-XXIX



Fotometrie | Photometries  
 p. 83

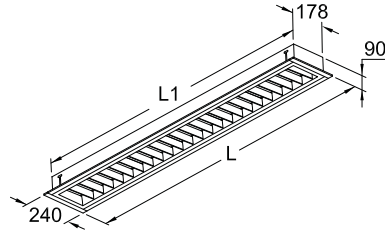

# CONTROLLED EB DARK

Apparecchio da incasso professionale LED ideale per controsoffitti in lastra o controsoffitti a doghe.  
LED professional recessed lighting fitting, ideal for sheet false ceilings or stave false ceilings.

**[L]** Lunghezze disponibili | Available lengths:  
**630 mm - 1185 mm - 1560 mm**

**[L1]** Lunghezze disponibili | Available lengths:  
**582 mm - 1137 mm - 1512 mm**



**A RICHIESTA | ON REQUEST**

<b>5Y WARRANTY</b> 5% FAILURE RATE	<b>60.000 h</b> LED LIFETIME <b>L90B10</b>	<b>100.000 h</b> LED LIFETIME <b>L70B50</b>
---------------------------------------	---	--

<b>&gt;90</b> CRI	<b>EM</b> EN 60918-2-22	<b>DL</b> DALI	<b>PD</b> PUSH DIM
----------------------	----------------------------	-------------------	-----------------------

Relamping	Lumen LED*	Watt LED**	Lumen Out***	Watt	Lumen Watt Out	Configurazione LED LED configuration	Codice Code	K	Alimentazione Power Supply	Schermo Diffuser	Colore Colour
<b>[L]</b> Lunghezza/Lengths - 630 mm											
1x18	<b>1821</b>	10	1302	11	> 118	—	<b>EBD10</b>	<b>W:</b> 3.000	— : CAE A RICHIESTA   ON REQUEST	— : microprismato microprismatic	<b>01:</b> bianco white
2x18	<b>3642</b>	20	2605	21	> 124	==	<b>EBD20</b>	<b>N:</b> 4.000	<b>DL:</b> DALI <b>PD:</b> PUSH DIM		<b>05:</b> grigio silver
<b>[L]</b> Lunghezza/Lengths - 1185 mm											
1x36	<b>3375</b>	17	2362	18,5	> 128	—	<b>EBD22</b>	<b>W:</b> 3.000	— : CAE A RICHIESTA   ON REQUEST	— : microprismato microprismatic	<b>01:</b> bianco white
2x36	<b>6750</b>	34	4725	37	> 128	==	<b>EBD44</b>	<b>N:</b> 4.000	<b>DL:</b> DALI <b>PD:</b> PUSH DIM		<b>05:</b> grigio silver
<b>[L]</b> Lunghezza/Lengths - 1560 mm											
1x58	<b>4500</b>	23	3150	24,5	> 128	—	<b>EBD29</b>	<b>W:</b> 3.000	— : CAE A RICHIESTA   ON REQUEST	— : microprismato microprismatic	<b>01:</b> bianco white
2x58	<b>9000</b>	46	6300	49	> 128	==	<b>EBD58</b>	<b>N:</b> 4.000	<b>DL:</b> DALI <b>PD:</b> PUSH DIM		<b>05:</b> grigio silver

<b>CE</b>	<b>&gt;80</b> CRI	<b>IP40</b> EN 60529	<b>230 V</b> 2014/35/UE	<b>50/60</b> Hz	<b>IK 02</b> EN 60668
<b>850°</b> EN 60695	<b>A++</b> A+	<b>RG 0</b> EN 62471	<b>01</b> WHITE	<b>05</b> SILVER	<b>SELV</b>

**16**  
UGR

TEMPERATURA AMBIENTE MIN E MAX | MIN AND MAX ROOM TEMPERATURE: **(-10° +40°)**

\* Lumen nominali LED max a 25° | Nominal lumen at max 25°

\*\* Potenza dei LED | LED power

\*\*\* Flusso totale in uscita dall'apparecchio a temperatura di lavoro (Ta 25° - 4.000 K) | Total lighting fitting flux output at working temperature (Ta 25° - 4.000 K) | (3.000 K -8% - CRI 90 -10%)

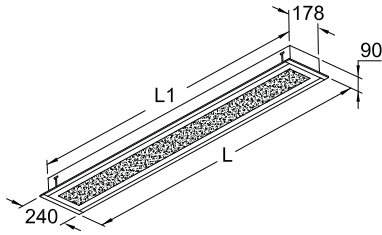

**[L]** Lunghezze disponibili | Available lengths:  
630 mm - 1185 mm - 1560 mm

**[L1]** Lunghezze disponibili | Available lengths:  
582 mm - 1137 mm - 1512 mm



A RICHIESTA | ON REQUEST



# CONTROLLED EB UGR

Apparecchio da incasso professionale LED ideale per controsoffitti in lastra o controsoffitti a doghe.  
LED professional recessed lighting fitting, ideal for sheet false ceilings or stave false ceilings.

Relamping	Lumen LED*	Watt LED**	Lumen Out***	Watt	Lumen Watt Out	Configurazione LED LED configuration	Codice Code	K	Alimentazione Power Supply	Schermo Diffuser	Colore Colour
<b>[L]</b> Lunghezza/Lengths - 630 mm											
1x18	1821	10	1330	11	> 121	—	<b>EBM10</b>	W: 3.000	— : CAE A RICHIESTA   ON REQUEST	— : microprismato microprismatic	<b>01:</b> bianco white
2x18	3642	20	2660	21	> 127	==	<b>EBM20</b>	N: 4.000	DL: DALI PD: PUSH DIM		<b>05:</b> grigio silver
<b>[L]</b> Lunghezza/Lengths - 1185 mm											
1x36	3375	17	2405	18,5	> 130	—	<b>EBM22</b>	W: 3.000	— : CAE A RICHIESTA   ON REQUEST	— : microprismato microprismatic	<b>01:</b> bianco white
2x36	6750	34	4810	37	> 130	==	<b>EBM44</b>	N: 4.000	DL: DALI PD: PUSH DIM		<b>05:</b> grigio silver
<b>[L]</b> Lunghezza/Lengths - 1560 mm											
1x58	4500	23	3185	24,5	> 130	—	<b>EBM29</b>	W: 3.000	— : CAE A RICHIESTA   ON REQUEST	— : microprismato microprismatic	<b>01:</b> bianco white
2x58	9000	46	6370	49	> 130	==	<b>EBM58</b>	N: 4.000	DL: DALI PD: PUSH DIM		<b>05:</b> grigio silver

CE

>80 CRI

IP40 EN 60529

230 V 2014/35/UE

50/60 Hz

IK 07 EN 60668

850° EN 60695

A++ A+ A

RG 0 EN 62471

01 WHITE

05 SILVER

SELV

19 UGR

TEMPERATURA AMBIENTE MIN E MAX | MIN AND MAX ROOM TEMPERATURE: (-10° +40°)

\* Lumen nominali LED max a 25° | Nominal lumen at max 25°

\*\* Potenza dei LED | LED power

\*\*\* Flusso totale in uscita dall'apparecchio a temperatura di lavoro (Ta 25° - 4.000 K) | Total lighting fitting flux output at working temperature (Ta 25° - 4.000 K) | (3.000 K -8% - CRI 90 -10%)

Descrizione prodotto | Product description p. 82

Schema di cablaggio | Connection scheme p. XXVIII-XXIX

Fotometrie | Photometries p. 83

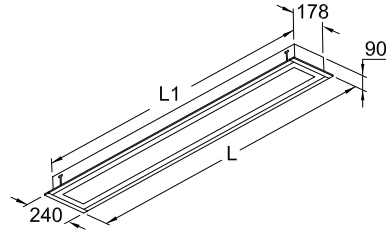

# CONTROLLED EB OPAL

Apparecchio da incasso professionale LED ideale per controsoffitti in lastra o controsoffitti a doghe.  
LED professional recessed lighting fitting, ideal for sheet false ceilings or stave false ceilings.

**[L]** Lunghezze disponibili | Available lengths:  
**630 mm - 1185 mm - 1560 mm**

**[L1]** Lunghezze disponibili | Available lengths:  
**582 mm - 1137 mm - 1512 mm**



**A RICHIESTA | ON REQUEST**

**5Y WARRANTY**  
5% FAILURE RATE

**60.000 h**  
LED LIFETIME **L90B10**

**100.000 h**  
LED LIFETIME **L70B50**

**>90**  
CRI

**EM**  
EN 60918-2-22

**DL**  
DALI

**PD**  
PUSH DIM

Relamping	Lumen LED*	Watt LED**	Lumen Out***	Watt	Lumen Watt Out	Configurazione LED LED configuration	Codice Code	K	Alimentazione Power Supply	Schermo Diffuser	Colore Colour
<b>[L]</b> Lunghezza/Lengths - 630 mm											
1x18	<b>1821</b>	10	1278	11	> 116	—	<b>EB10</b>	<b>W:</b> 3.000	— : CAE A RICHIESTA   ON REQUEST	— : opale opal	<b>01:</b> bianco white
2x18	<b>3642</b>	20	2557	21	> 122	==	<b>EB20</b>	<b>N:</b> 4.000	<b>DL:</b> DALI <b>PD:</b> PUSH DIM		<b>05:</b> grigio silver
<b>[L]</b> Lunghezza/Lengths - 1185 mm											
1x36	<b>3375</b>	17	2183	18,5	> 118	—	<b>EB22</b>	<b>W:</b> 3.000	— : CAE A RICHIESTA   ON REQUEST	— : opale opal	<b>01:</b> bianco white
2x36	<b>6750</b>	34	4366	37	> 118	==	<b>EB44</b>	<b>N:</b> 4.000	<b>DL:</b> DALI <b>PD:</b> PUSH DIM		<b>05:</b> grigio silver
<b>[L]</b> Lunghezza/Lengths - 1560 mm											
1x58	<b>4500</b>	23	2891	24,5	> 188	—	<b>EB29</b>	<b>W:</b> 3.000	— : CAE A RICHIESTA   ON REQUEST	— : opale opal	<b>01:</b> bianco white
2x58	<b>9000</b>	46	5783	49	> 118	==	<b>EB58</b>	<b>N:</b> 4.000	<b>DL:</b> DALI <b>PD:</b> PUSH DIM		<b>05:</b> grigio silver

**>80**  
CRI

**IP40**  
EN 60529

**230 V**  
2014/35/UE

**50/60**  
Hz

**IK 07**  
EN 60068

**850°**  
EN 60695

**A++**  
A+

**RG 0**  
EN 62471

**01**  
WHITE

**05**  
SILVER

**SELV**

TEMPERATURA AMBIENTE MIN E MAX | MIN AND MAX ROOM TEMPERATURE: **(-10° +40°)**

\* Lumen nominali LED max a 25° | Nominal lumen at max 25°  
 \*\* Potenza dei LED | LED power  
 \*\*\* Flusso totale in uscita dall'apparecchio a temperatura di lavoro (Ta 25° - 4.000 K) | Total lighting fitting flux output at working temperature (Ta 25° - 4.000 K) | (3.000 K -8% - CRI 90 -10%)



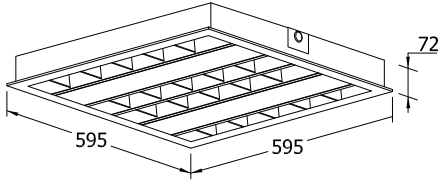

# CONTROLLED SPA

Apparecchio da incasso professionale LED a bassa luminanza.  
LED recessed professional lighting fitting, low luminance.



A RICHIESTA | ON REQUEST

**>90**  
CRI

**EM**  
EN 60598-2-22

**DL**  
DALI

**PD**  
PUSH DIM

**5Y WARRANTY**  
5% FAILURE RATE

**60.000 h**  
LED LIFETIME L90B10

**100.000 h**  
LED LIFETIME L70B50

Relamping	Lumen LED*	Watt LED**	Lumen Out***	Watt	Lumen Watt Out	Configurazione LED LED configuration	Codice Code	K	Alimentazione Power Supply	Colore Colour
4x18	<b>5020</b>	30	3665	32	> 115	=====	<b>CMSA40</b>		— : CAE A RICHIESTA   ON REQUEST DL: DALI PD: PUSH DIM	<b>01:</b> bianco white  <b>05:</b> grigio silver
4x24	<b>6800</b>	42	4965	45	> 110	=====	<b>CMSA48</b>	<b>W:</b> 3.000  <b>N:</b> 4.000		
2x55	<b>7020</b>	48	5125	51	> 100	=====	<b>CMSA56</b>			

**>80**  
CRI

**IP40**  
EN 60529

**230 V**  
2014/35/UE

**50/60**  
Hz

**IK 02**  
EN 60068

**850°**  
EN 60695

**01**  
WHITE

**05**  
SILVER

**SELV**

**16**  
UGR

TEMPERATURA AMBIENTE MIN E MAX | MIN AND MAX ROOM TEMPERATURE: (-10° +40°)

\* Lumen nominali LED max a 25° | Nominal lumen at max 25°  
 \*\* Potenza dei LED | LED power  
 \*\*\* Flusso totale in uscita dall'apparecchio a temperatura di lavoro (Ta 25° - 4.000 K) | Total lighting fitting flux output at working temperature (Ta 25° - 4.000 K) | (3.000 K -8% - CRI 90 -10%)

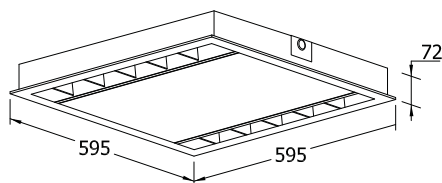

# CONTROLLED SPA 2 LUCI

Apparecchio da incasso professionale LED a bassa luminanza.  
LED recessed professional lighting fitting, low luminance.



A RICHIESTA | ON REQUEST

<b>5Y WARRANTY</b> 5% FAILURE RATE	<b>60.000 h</b> LED LIFETIME L90B10	<b>100.000 h</b> LED LIFETIME L70B50
---------------------------------------	--	---

<b>&gt;90</b> CRI	<b>EM</b> EN 60910-2-22	<b>DL</b> DALI	<b>PD</b> PUSH DIM
----------------------	----------------------------	-------------------	-----------------------

Relamping	Lumen LED*	Watt LED**	Lumen Out***	Watt	Lumen Watt Out	Configurazione LED LED configuration	Codice Code	K	Alimentazione Power Supply	Colore Colour
2x18	<b>2510</b>	15	1830	16	> 114	=====	<b>CMSA2L40</b>	<b>W:</b> 3,000  <b>N:</b> 4,000	-- : CAE  A RICHIESTA   ON REQUEST <b>DL:</b> DALI <b>PD:</b> PUSH DIM	<b>01:</b> bianco white  <b>05:</b> grigio silver
2x24	<b>3400</b>	21	2480	22,5	> 110	=====	<b>CMSA2L48</b>			
1x55	<b>3510</b>	24	2562	25,5	> 100	=====	<b>CMSA2L56</b>			

<b>CE</b>		<b>&gt;80</b> CRI	<b>IP40</b> EN 60529	<b>230 V</b> 2014/35/UE	<b>50/60</b> Hz	<b>IK 02</b> EN 60068
<b>850°</b> EN 60695		<b>RG 0</b> EN 62471		<b>01</b> WHITE	<b>05</b> SILVER	<b>16</b> UGR

TEMPERATURA AMBIENTE MIN E MAX | MIN AND MAX ROOM TEMPERATURE: (-10° +40°)

\* Lumen nominali LED max a 25° | Nominal lumen at max 25°

\*\* Potenza dei LED | LED power

\*\*\* Flusso totale in uscita dall'apparecchio a temperatura di lavoro (Ta 25° - 4.000 K) | Total lighting fitting flux output at working temperature (Ta 25° - 4.000 K) | (3.000 K -8% - CRI 90 -10%)

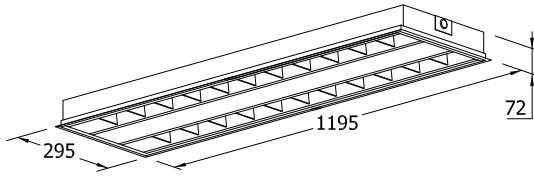

# CONTROLLED SPA R

Apparecchio da incasso professionale LED a bassa luminanza.  
LED recessed professional lighting fitting, low luminance.



A RICHIESTA | ON REQUEST

>90  
CRI

EM  
EN 60598-2-22

DL  
DALI

PD  
PUSH DIM

**5Y WARRANTY**  
5% FAILURE RATE

**60.000 h**  
LED LIFETIME L90B10

**100.000 h**  
LED LIFETIME L70B50

Relamping	Lumen LED*	Watt LED**	Lumen Out***	Watt	Lumen Watt Out	Configurazione LED LED configuration	Codice Code	K	Alimentazione Power Supply	Colore Colour
2x36	<b>5569</b>	27	4065	29	> 140	=====	<b>CMSAR40</b>		--- : CAE A RICHIESTA   ON REQUEST DL: DALI PD: PUSH DIM	<b>01:</b> bianco white  <b>05:</b> grigio silver
2x36	<b>6150</b>	34,5	4490	37	> 121	=====	<b>CMSAR48</b>	<b>W:</b> 3.000  <b>N:</b> 4.000		
2x49	<b>8025</b>	48	5860	51	> 115	=====	<b>CMSAR56</b>			

CE

>80  
CRI

IP40  
EN 60529

230 V  
2014/35/UE

50/60  
Hz

IK 02  
EN 60068

850°  
EN 60695

A++  
A+  
A

RG 0  
EN 62471

01  
WHITE

05  
SILVER

16  
UGR

TEMPERATURA AMBIENTE MIN E MAX | MIN AND MAX ROOM TEMPERATURE: (-10° +40°)

\* Lumen nominali LED max a 25° | Nominal lumen at max 25°

\*\* Potenza dei LED | LED power

\*\*\* Flusso totale in uscita dall'apparecchio a temperatura di lavoro (Ta 25° - 4.000 K) | Total lighting fitting flux output at working temperature (Ta 25° - 4.000 K) | (3.000 K -8% - CRI 90 -10%)

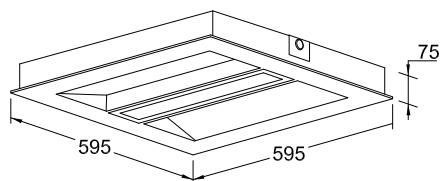
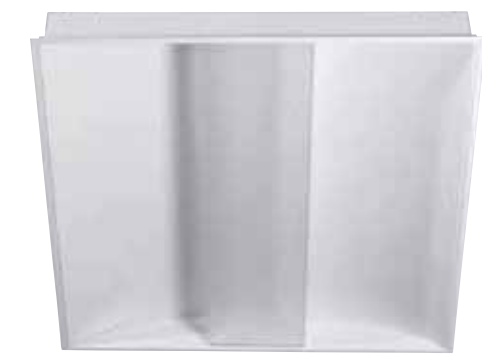

# CONTROL FLAT LED MP

Apparecchio da incasso professionale LED a bassa luminanza.  
LED recessed professional lighting fitting, low luminance.



A RICHIESTA | ON REQUEST

<b>5Y WARRANTY</b> 5% FAILURE RATE	<b>60.000 h</b> LED LIFETIME L90B10	<b>100.000 h</b> LED LIFETIME L70B50
---------------------------------------	--	---

<b>&gt;90</b> CRI	<b>EM</b> EN 60910-2-22	<b>DL</b> DALI	<b>PD</b> PUSH DIM
----------------------	----------------------------	-------------------	-----------------------

Relamping	Lumen LED*	Watt LED**	Lumen Out***	Watt	Lumen Watt Out	Configurazione LED LED configuration	Codice Code	K	Alimentazione Power Supply	Schermo Diffuser	Colore Colour
2x24	<b>2200</b>	13,5	1790	14,5	> 123	—	<b>CF30MP</b>	W: 3.000 N: 4.000	— : CAE A RICHIESTA   ON REQUEST DL: DALI PD: PUSH DIM	— : microprismato microprismatic	<b>01:</b> bianco white
2x40	<b>4400</b>	27	3585	29	> 124	==	<b>CF36MP</b>				<b>05:</b> grigio silver
2x55	<b>6600</b>	41	5375	44	> 122	===	<b>CF42MP</b>				

<b>CE</b>		<b>&gt;80</b> CRI	<b>IP40</b> EN 60529	<b>230 V</b> 2014/35/UE	<b>50/60</b> Hz	<b>IK 02</b> EN 60068
<b>850°</b> EN 60695		<b>RG 0</b> EN 62471		<b>01</b> WHITE	<b>05</b> SILVER	<b>19</b> UGR

TEMPERATURA AMBIENTE MIN E MAX | MIN AND MAX ROOM TEMPERATURE: **(-10° +40°)**

\* Lumen nominali LED max a 25° | Nominal lumen at max 25°

\*\* Potenza dei LED | LED power

\*\*\* Flusso totale in uscita dall'apparecchio a temperatura di lavoro (Ta 25° - 4.000 K) | Total lighting fitting flux output at working temperature (Ta 25° - 4.000 K) | (3.000 K -8% - CRI 90 -10%)



Fotometrie | Photometries  
p. 85



Schema di cablaggio | Connection scheme  
p. XXVIII-XXIX



Descrizione prodotto | Product description  
p. 84

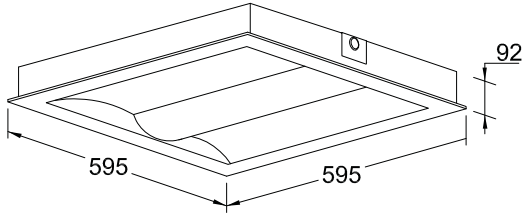

# MOREFLAT MP

Apparecchio da incasso professionale LED a bassa luminanza.  
LED recessed professional lighting fitting, low luminance.



A RICHIESTA | ON REQUEST

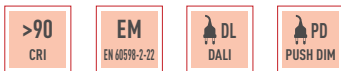

**5Y WARRANTY**  
5% FAILURE RATE

**60.000 h**  
LED LIFETIME L90B10

**100.000 h**  
LED LIFETIME L70B50

Relamping	Lumen LED*	Watt LED**	Lumen Out***	Watt	Lumen Watt Out	Configurazione LED LED configuration	Codice Code	K	Alimentazione Power Supply	Schermo Diffuser	Colore Colour
2x24	<b>2200</b>	13,5	1790	14,5	> 123	—	<b>MF30MP</b>		— : CAE A RICHIESTA   ON REQUEST <b>DL</b> : DALI <b>PD</b> : PUSH DIM	— : microprismato microprismatic	<b>01</b> : bianco white
2x40	<b>4400</b>	27	3585	29	> 124	==	<b>MF36MP</b>	<b>W</b> : 3.000 <b>N</b> : 4.000			<b>05</b> : grigio silver
2x55	<b>6600</b>	41	5375	44	> 122	===	<b>MF42MP</b>				



TEMPERATURA AMBIENTE MIN E MAX | MIN AND MAX ROOM TEMPERATURE: (-10° +40°)

\* Lumen nominali LED max a 25° | Nominal lumen at max 25°

\*\* Potenza dei LED | LED power

\*\*\* Flusso totale in uscita dall'apparecchio a temperatura di lavoro (Ta 25° - 4.000 K) | Total lighting fitting flux output at working temperature (Ta 25° - 4.000 K) | (3.000 K -8% - CRI 90 -10%)

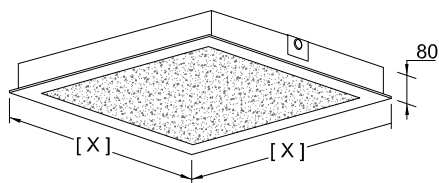

**[X]** Dimensioni disponibili | Available dimensions:  
595x595 mm - 595x1195 mm

# CONTROPLUS UGR

Apparecchio da incasso professionale LED a bassa luminanza.  
LED recessed professional lighting fitting, low luminance.



A RICHIESTA | ON REQUEST

<b>5Y WARRANTY</b> 5% FAILURE RATE	<b>60.000 h</b> LED LIFETIME L90B10	<b>100.000 h</b> LED LIFETIME L70B50
---------------------------------------	--	---

<b>&gt;90</b> CRI	<b>EM</b> EN 60910-2-22	<b>DL</b> DALI	<b>PD</b> PUSH DIM
----------------------	----------------------------	-------------------	-----------------------

Relamping	Lumen LED*	Watt LED**	Lumen Out***	Watt	Lumen Watt Out	Configurazione LED LED configuration	Codice Code	K	Alimentazione Power Supply	Schermo Diffuser	Colore Colour
<b>[X]</b> Dimensioni/Dimensions - 595x595 mm											
4x14	<b>4640</b>	24,5	3368	26	> 130		<b>CPM30</b>	<b>W:</b> 3.000 <b>N:</b> 4.000	<b>—</b> : CAE A RICHIESTA   ON REQUEST <b>DL</b> : DALI <b>PD</b> : PUSH DIM	<b>—</b> : microprismato microprismatic	<b>01:</b> bianco white
4x18	<b>5500</b>	30	3992	31,5	> 127		<b>CPM36</b>				<b>05:</b> grigio silver
4x18	<b>6370</b>	35	4623	37,5	> 123		<b>CPM42</b>				
4x24	<b>7190</b>	40	5219	42,5	> 123		<b>CPM49</b>				
<b>[X]</b> Dimensioni/Dimensions - 595x1195 mm											
4x28	<b>8920</b>	51	6474	52	> 125		<b>CPM50</b>	<b>W:</b> 3.000 <b>N:</b> 4.000	<b>—</b> : CAE A RICHIESTA   ON REQUEST <b>DL</b> : DALI <b>PD</b> : PUSH DIM	<b>—</b> : microprismato microprismatic	<b>01:</b> bianco white
4x36	<b>11000</b>	60	7984	63	> 127		<b>CPM60</b>				<b>05:</b> grigio silver
4x36	<b>12740</b>	70	9247	75	> 123		<b>CPM80</b>				
4x54	<b>14380</b>	80	10437	85	> 123		<b>CPM85</b>				

<b>CE</b>		<b>&gt;80</b> CRI	<b>IP55</b> EN 60529	<b>230 V</b> 2014/35/UE	<b>50/60</b> Hz	<b>IK 07</b> EN 60068
<b>850°</b> EN 60695		<b>RG 0</b> EN 62471		<b>01</b> WHITE	<b>05</b> SILVER	<b>19</b> UGR

TEMPERATURA AMBIENTE MIN E MAX | MIN AND MAX ROOM TEMPERATURE: **(-20° +40°)**

\* Lumen nominali LED max a 25° | Nominal lumen at max 25°

\*\* Potenza dei LED | LED power

\*\*\* Flusso totale in uscita dall'apparecchio a temperatura di lavoro (Ta 25° - 4.000 K) | Total lighting fitting flux output at working temperature (Ta 25° - 4.000 K) | (3.000 K -8% - CRI 90 -10%)



Fotometrie | Photometries  
p. 85



Schema di cablaggio | Connection scheme  
p. XXVIII-XXIX



Descrizione prodotto | Product description  
p. 84

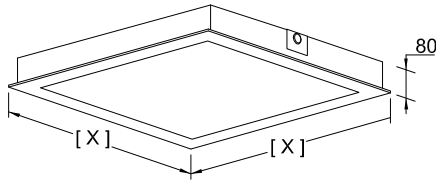

**[X]** Dimensioni disponibili | Available dimensions:  
**595x595 mm - 595x1195 mm**

# CONTROPLUS OPAL

Apparecchio da incasso professionale LED.  
 LED recessed professional lighting fitting.



**A RICHIESTA | ON REQUEST**

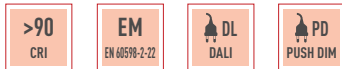

**5Y WARRANTY**  
 5% FAILURE RATE

**60.000 h**  
 LED LIFETIME L90B10

**100.000 h**  
 LED LIFETIME L70B50

Relamping	Lumen LED*	Watt LED**	Lumen Out***	Watt	Lumen Watt Out	Configurazione LED LED configuration	Codice Code	K	Alimentazione Power Supply	Schermo Diffuser	Colore Colour	
<b>[X] Dimensioni/Dimensions - 595x595 mm</b>												
	4x14	<b>4640</b>	24,5	2962	26	> 114		<b>CPO30</b>		--- : CAE A RICHIESTA   ON REQUEST DL: DALI PD: PUSH DIM	--- : opale opal	<b>01:</b> bianco white  <b>05:</b> grigio silver
	4x18	<b>5500</b>	30	3511	31,5	> 111		<b>CPO36</b>	W: 3.000			
	4x18	<b>6370</b>	35	4067	37,5	> 108		<b>CPO42</b>	N: 4.000			
	4x24	<b>7190</b>	40	4590	42,5	> 108		<b>CPO49</b>				
<b>[X] Dimensioni/Dimensions - 595x1195 mm</b>												
	4x28	<b>8920</b>	51	5695	52	> 110		<b>CPO50</b>		--- : CAE A RICHIESTA   ON REQUEST DL: DALI PD: PUSH DIM	--- : opale opal	<b>01:</b> bianco white  <b>05:</b> grigio silver
	4x36	<b>11000</b>	60	7023	63	> 111		<b>CPO60</b>	W: 3.000			
	4x36	<b>12740</b>	70	8134	75	> 108		<b>CPO80</b>	N: 4.000			
	4x54	<b>14380</b>	80	9181	85	> 108		<b>CPO85</b>				



TEMPERATURA AMBIENTE MIN E MAX | MIN AND MAX ROOM TEMPERATURE: **(-20° +40°)**

\* Lumen nominali LED max a 25° | Nominal lumen at max 25°

\*\* Potenza dei LED | LED power

\*\*\* Flusso totale in uscita dall'apparecchio a temperatura di lavoro (Ta 25° - 4.000 K) | Total lighting fitting flux output at working temperature (Ta 25° - 4.000 K) | (3.000 K -8% - CRI 90 -10%)



DESCRIZIONE ACCESSORIO  
*ACCESSORY DESCRIPTION*CODICE  
*CODE***TELAIO DECO HALL**  
RENDIMENTO OTTICO 53%***DECO HALL FRAME***  
*OPTIC PERFORMANCE 53%***CDH****TELAIO DECO ZIP**  
RENDIMENTO OTTICO 98%***DECO ZIP FRAME***  
*OPTIC PERFORMANCE 98%***CDZ****TELAIO DECO LINEAR**  
RENDIMENTO OTTICO 47%***DECO LINEAR FRAME***  
*OPTIC PERFORMANCE 47%***CDL****TELAIO DECO TRIAL**  
RENDIMENTO OTTICO 47%***DECO TRIAL FRAME***  
*OPTIC PERFORMANCE 47%***CDT**

- Serie di telai frontali decorativi disponibili su richiesta per l'articolo CONTROPLUS OPAL (non ordinabile separatamente dall'apparecchio).
- *Range of decorative front frames available on request for the article CONTROPLUS OPAL (non orderable separately from the fixture).*

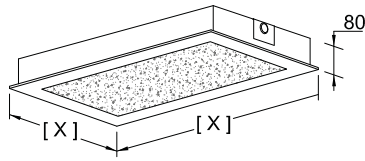

# CONTROPLUS R UGR

**[X]** Dimensioni disponibili | Available dimensions:  
**295x1195 mm - 295x595 mm**



Apparecchio da incasso professionale LED a bassa luminanza.  
 LED recessed professional lighting fitting, low luminance.

**A RICHIESTA | ON REQUEST**

**>90**  
CRI

**EM**  
EN 60598-2-22

DL  
DALI

PD  
PUSH DIM

**5Y WARRANTY**  
5% FAILURE RATE

**60.000 h**  
LED LIFETIME L90B10

**100.000 h**  
LED LIFETIME L70B50

Relamping	Lumen LED*	Watt LED**	Lumen Out***	Watt	Lumen Watt Out	Configurazione LED LED configuration	Codice Code	K	Alimentazione Power Supply	Schermo Diffuser	Colore Colour
<b>[X]</b> Dimensioni/Dimensions - 295x1195 mm											
2x28	<b>4838</b>	25	3800	26	> 146	===	<b>CPRM30</b>		--- : CAE A RICHIESTA   ON REQUEST <b>DL:</b> DALI <b>PD:</b> PUSH DIM	--- : microprismato microprismatic	<b>01:</b> bianco white
2x36	<b>5670</b>	30,5	4454	32	> 139	===	<b>CPRM36</b>	<b>W:</b> 3.000			<b>05:</b> grigio silver
2x36	<b>6550</b>	36	5145	38	> 135	===	<b>CPRM42</b>	<b>N:</b> 4.000			
2x54	<b>7380</b>	41,5	5797	44	> 132	===	<b>CPRM49</b>				
<b>[X]</b> Dimensioni/Dimensions - 295x595 mm											
2x14	<b>1575</b>	8,5	1237	9	> 137	===	<b>CPRM10</b>		--- : CAE A RICHIESTA   ON REQUEST <b>DL:</b> DALI <b>PD:</b> PUSH DIM	--- : microprismato microprismatic	<b>01:</b> bianco white
2x18	<b>1821</b>	10	1430	11	> 130	===	<b>CPRM11</b>	<b>W:</b> 3.000			<b>05:</b> grigio silver
2x24	<b>2049</b>	11	1610	12	> 134	===	<b>CPRM12</b>	<b>N:</b> 4.000			

**>80**  
CRI

**IP55**  
EN 60529

**230 V**  
2014/35/UE

**50/60**  
Hz

**IK 07**  
EN 60068

**850°**  
EN 60695

**RG 0**  
EN 62471

**01**  
WHITE

**05**  
SILVER

**19**  
UGR

TEMPERATURA AMBIENTE MIN E MAX | MIN AND MAX ROOM TEMPERATURE: (-20° +40°)

\* Lumen nominali LED max a 25° | Nominal lumen at max 25°

\*\* Potenza dei LED | LED power

\*\*\* Flusso totale in uscita dall'apparecchio a temperatura di lavoro (Ta 25° - 4.000 K) | Total lighting fitting flux output at working temperature (Ta 25° - 4.000 K) | (3.000 K -8% - CRI 90 -10%)

Descrizione prodotto | Product description  
 p. 86

Schema di cablaggio | Connection scheme  
 p. XXVIII-XXIX

Fotometrie | Photometries  
 p. 87

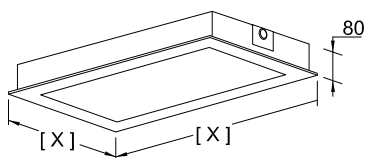

# CONTROPLUS R OPAL

**[X]** Dimensioni disponibili | Available dimensions:  
**295x1195 mm - 295x595 mm**

Apparecchio da incasso professionale LED.  
 LED recessed professional lighting fitting.



**A RICHIESTA | ON REQUEST**

<b>5Y WARRANTY</b> 5% FAILURE RATE	<b>60.000 h</b> LED LIFETIME L90B10	<b>100.000 h</b> LED LIFETIME L70B50
---------------------------------------	--	---

<b>&gt;90</b> CRI	<b>EM</b> EN 60918-2-22	<b>DL</b> DALI	<b>PD</b> PUSH DIM
----------------------	----------------------------	-------------------	-----------------------

Relamping	Lumen LED*	Watt LED**	Lumen Out***	Watt	Lumen Watt Out	Configurazione LED LED configuration	Codice Code	K	Alimentazione Power Supply	Schermo Diffuser	Colore Colour
<b>[X]</b> Dimensioni/Dimensions - 295x1195 mm											
2x28	<b>4838</b>	25	3088	26	> 119	==	<b>CPRO30</b>		— : CAE A RICHIESTA   ON REQUEST <b>DL</b> : DALI <b>PD</b> : PUSH DIM	— : opale opal	<b>01</b> : bianco white
2x36	<b>5670</b>	30,5	3619	32	> 113	==	<b>CPRO36</b>	<b>W</b> : 3.000			<b>05</b> : grigio silver
2x36	<b>6550</b>	36	4181	38	> 110	==	<b>CPRO42</b>	<b>N</b> : 4.000			
2x54	<b>7380</b>	41,5	4711	44	> 107	==	<b>CPRO49</b>				
<b>[X]</b> Dimensioni/Dimensions - 295x595 mm											
2x14	<b>1575</b>	8,5	1005	9	> 112	==	<b>CPRO10</b>		— : CAE A RICHIESTA   ON REQUEST <b>DL</b> : DALI <b>PD</b> : PUSH DIM	— : opale opal	<b>01</b> : bianco white
2x18	<b>1821</b>	10	1162	11	> 106	==	<b>CPRO11</b>	<b>W</b> : 3.000			<b>05</b> : grigio silver
2x24	<b>2049</b>	11	1308	12	> 109	==	<b>CPRO12</b>	<b>N</b> : 4.000			

<b>CE</b>	<b>&gt;80</b> CRI	<b>IP55</b> EN 60529	<b>230 V</b> 2014/35/UE	<b>50/60</b> Hz	<b>IK 07</b> EN 60068
<b>850°</b> EN 60695	<b>A++</b> A+	<b>RG 0</b> EN 62471	<b>01</b> WHITE	<b>05</b> SILVER	

TEMPERATURA AMBIENTE MIN E MAX | MIN AND MAX ROOM TEMPERATURE: **(-20° +40°)**

\* Lumen nominali LED max a 25° | Nominal lumen at max 25°

\*\* Potenza dei LED | LED power

\*\*\* Flusso totale in uscita dall'apparecchio a temperatura di lavoro (Ta 25° - 4.000 K) | Total lighting fitting flux output at working temperature (Ta 25° - 4.000 K) | (3.000 K -8% - CRI 90 -10%)



Fotometrie | Photometries  
 p. 87



Schema di cablaggio | Connection scheme  
 p. XXVIII-XXIX



Descrizione prodotto | Product description  
 p. 86

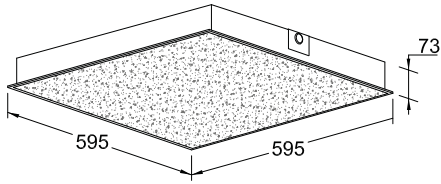

# COMPATTA UGR

Apparecchio da incasso professionale LED a bassa luminanza.  
LED recessed professional lighting fitting, low luminance.



A RICHIESTA | ON REQUEST

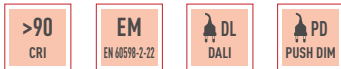

**5Y WARRANTY**  
5% FAILURE RATE

**60.000 h**  
LED LIFETIME L90B10

**100.000 h**  
LED LIFETIME L70B50

Relamping	Lumen LED*	Watt LED**	Lumen Out***	Watt	Lumen Watt Out	Configurazione LED LED configuration	Codice Code	K	Alimentazione Power Supply	Schermo Diffuser	Colore Colour
4x14	<b>3315</b>	17,5	2603	18,5	> 141		<b>CCPM19</b>		— : CAE A RICHIESTA   ON REQUEST DL: DALI PD: PUSH DIM	— : microprismato microprismatic	<b>01:</b> bianco white
4x18	<b>3937</b>	21,5	3092	22,5	> 137		<b>CCPM23</b>	W: 3.000			<b>05:</b> grigio silver
4x18	<b>4665</b>	25,5	3664	27	> 136		<b>CCPM27</b>	N: 4.000			
4x24	<b>5120</b>	28,5	4021	30	> 134		<b>CCPM30</b>				



TEMPERATURA AMBIENTE MIN E MAX | MIN AND MAX ROOM TEMPERATURE: (-10° +40°)

\* Lumen nominali LED max a 25° | Nominal lumen at max 25°  
 \*\* Potenza dei LED | LED power  
 \*\*\* Flusso totale in uscita dall'apparecchio a temperatura di lavoro (Ta 25° - 4.000 K) | Total lighting fitting flux output at working temperature (Ta 25° - 4.000 K) | (3.000 K -8% - CRI 90 -10%)

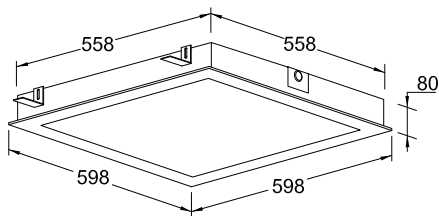

# CONTROL CLIP-IN UGR

Apparecchio da incasso professionale LED a bassa luminanza.  
 Idoneo per installazioni in controsoffitti tipo "CLIP-IN"  
*LED professional recessed lighting fitting low luminance. Suitable for  
 "CLIP-IN" false ceiling installation. Adjustment from closer panels.*



A RICHIESTA | ON REQUEST

<b>5Y WARRANTY</b> 5% FAILURE RATE	<b>60.000 h</b> LED LIFETIME L90B10	<b>100.000 h</b> LED LIFETIME L70B50
---------------------------------------	--	---

<b>&gt;90</b> CRI	<b>EM</b> EN 60598-2-22	<b>DL</b> DALI	<b>PD</b> PUSH DIM
----------------------	----------------------------	-------------------	-----------------------

Relamping	Lumen LED*	Watt LED**	Lumen Out***	Watt	Lumen Watt Out	Configurazione LED LED configuration	Codice Code	K	Alimentazione Power Supply	Schermo Diffuser	Colore Colour
	4x14	<b>4640</b>	24,5	3368	26	> 130		<b>CPIN30</b>	<b>W:</b> 3.000 <b>N:</b> 4.000 --- : CAE A RICHIESTA   ON REQUEST <b>DL:</b> DALI <b>PD:</b> PUSH DIM	--- : microprismato microprismatic	<b>01:</b> bianco white  <b>05:</b> grigio silver
	4x18	<b>5500</b>	30	3992	31,5	> 127		<b>CPIN36</b>			
	4x18	<b>6370</b>	35	4623	37,5	> 123		<b>CPIN42</b>			
	4x24	<b>7190</b>	40	5219	42,5	> 123		<b>CPIN49</b>			

## FOCUS PRODOTTO | PRODUCT FOCUS

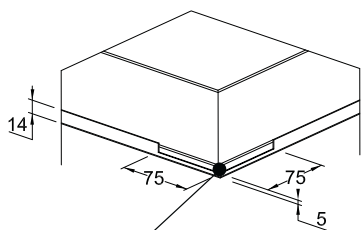

Dettaglio spigoli ribassati.  
Sharp edges details.

Staffa regolabile.  
Adjustable bracket.

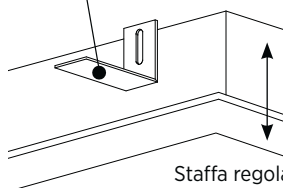

Staffa regolabile dai pannelli adiacenti.  
Adjustable bracket from adjacent panels.

**A RICHIESTA / ON REQUEST:**  
 Sagoma e dimensioni speciali personalizzabili  
 per differenti tipi di controsoffitti **CLIP-IN**.

*Special frame and dimensions for  
 different type of **CLIP-IN** false ceiling.*

<b>CE</b>		<b>&gt;80</b> CRI	<b>IP55</b> EN 60529	<b>230 V</b> 2014/35/UE	<b>50/60</b> Hz	<b>IK 07</b> EN 60068
<b>850°</b> EN 60695	<b>A++</b> A+ A	<b>RG 0</b> EN 62471		<b>01</b> WHITE	<b>05</b> SILVER	<b>19</b> UGR

TEMPERATURA AMBIENTE MIN E MAX | MIN AND MAX ROOM TEMPERATURE: **(-20° +40°)**

\* Lumen nominali LED max a 25° | Nominal lumen at max 25°

\*\* Potenza dei LED | LED power

\*\*\* Flusso totale in uscita dall'apparecchio a temperatura di lavoro (Ta 25° - 4.000 K) | Total lighting fitting flux output at working temperature (Ta 25° - 4.000 K) | (3.000 K -8% - CRI 90 -10%)



Fotometrie | Photometrics  
p. 87



Schema di cablaggio | Connection scheme  
p. XXVIII-XXIX

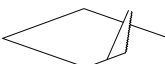
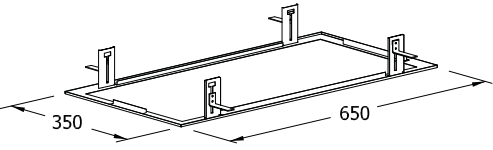
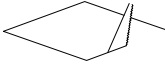
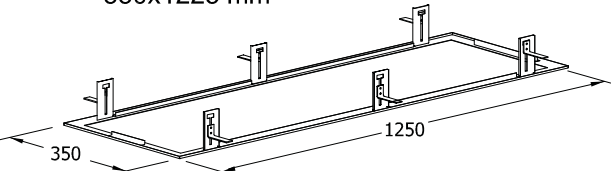
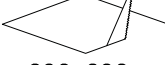
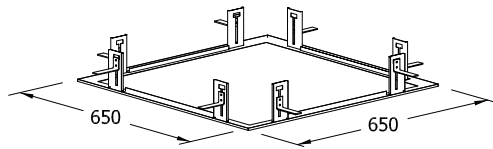
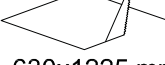
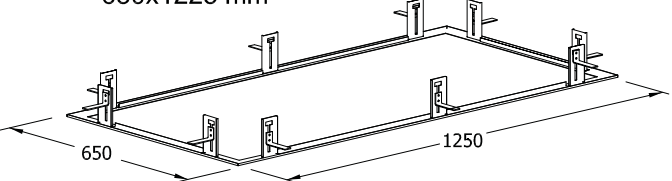

Descrizione prodotto | Product description  
p. 86

	DESCRIZIONE ACCESSORIO ACCESSORY DESCRIPTION	IDONEO PER: SUITABLE FOR:	CODICE CODE
 <b>330x630 mm</b> 	Telaio per controsoffitti in lastra per apparecchi 295x595 mm. <i>False ceiling frame for fixture 295x595 mm.</i>	INCASSI IN APPOGGIO <i>T BAR CEILING RECESSED MOUNTED FITTINGS</i>	<b>TLC1</b>
 <b>330x1225 mm</b> 	Telaio per controsoffitti in lastra per apparecchi 295x1195 mm. <i>False ceiling frame for fixture 295x1195 mm.</i>	INCASSI IN APPOGGIO <i>T BAR CEILING RECESSED MOUNTED FITTINGS</i>	<b>TLC2</b>
 <b>630x630 mm</b> 	Telaio per controsoffitti in lastra per apparecchi 595x595 mm. <i>False ceiling frame for fixture 595x595 mm.</i>	INCASSI IN APPOGGIO <i>T BAR CEILING RECESSED MOUNTED FITTINGS</i>	<b>TLC3</b>
 <b>630x1225 mm</b> 	Telaio per controsoffitti in lastra per apparecchi 595x1195 mm. <i>False ceiling frame for fixture 595x1195 mm.</i>	INCASSI IN APPOGGIO <i>T BAR CEILING RECESSED MOUNTED FITTINGS</i>	<b>TLC4</b>



**FOCUS PRODOTTO | PRODUCT FOCUS - TELAI PER CONTROSOFFITTI CHIUSI | FRAMES FOR CLOSED FALSE CEILING**

Permette l'installazione di tutti i prodotti IDEALLUX da incasso in soffitti in cartongesso.  
 Allow the installation of all IDEALLUX recessed fittings in false ceiling.

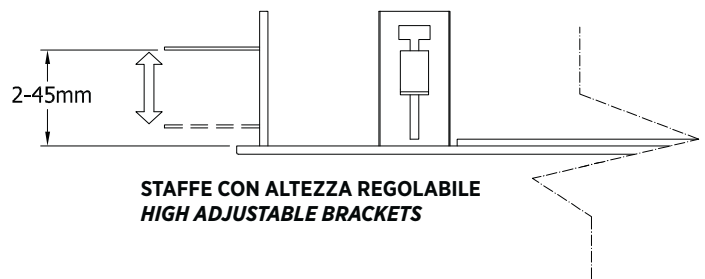

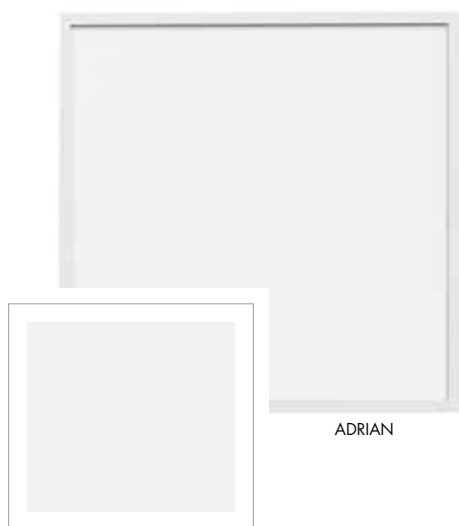

Particolare del diffusore opale in PMMA.  
Diffusor details in opal PMMA.

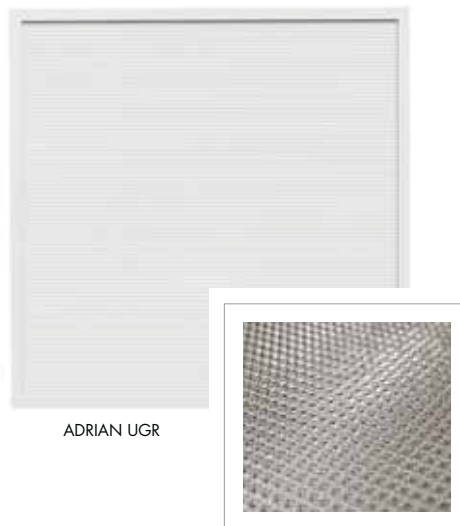

Particolare del diffusore microprismatico in PMMA.  
Diffusor details in microprismatic PMMA.

# ADRIAN - ADRIAN UGR

Apparecchio da incasso professionale LED a bassa luminanza.  
LED recessed professional lighting fitting, low luminance.



**3Y WARRANTY**  
5% FAILURE RATE

**30.000 h**  
LED LIFETIME L90B10

**A RICHIESTA | ON REQUEST**



Relamping	Lumen LED*	Watt LED**	Lumen Out***	Watt	Lumen Watt Out	Configurazione LED LED configuration	Codice Code	K	Alimentazione Power Supply	Schermo Diffuser	Colore Colour
<b>ADRIAN</b>											
4x14	<b>4100</b>	33	3150	36	> 88		<b>AD70</b>	<b>W:</b> 3.000	— : CAE A RICHIESTA   ON REQUEST	<b>22</b> UGR	<b>01:</b> bianco white
4x14	<b>4100</b>	33	3150	36	> 88		<b>AD750</b>	<b>N:</b> 4.000	<b>DL:</b> DALI <b>PD:</b> PUSH DIM	— : opale opal	
<b>ADRIAN UGR</b>											
4x14	<b>3800</b>	29	3150	32	> 119		<b>AD7UGN</b>	<b>W:</b> 3.000	— : CAE A RICHIESTA   ON REQUEST	<b>19</b> UGR	<b>01:</b> bianco white
4x14	<b>3800</b>	29	3150	32	> 119		<b>AD75UGN</b>	<b>N:</b> 4.000	<b>DL:</b> DALI <b>PD:</b> PUSH DIM	— : microprismato microprismatic	

		<b>&gt;80</b> CRI	<b>IP43</b> EN 60529	<b>230 V</b> 2014/35/UE	<b>50/60</b> Hz	<b>IK 07</b> EN 60068
<b>850°</b> EN 60695		<b>RG 0</b> EN 62471		<b>01</b> WHITE	<b>19</b> UGR	<b>22</b> UGR

TEMPERATURA AMBIENTE MIN E MAX | MIN AND MAX ROOM TEMPERATURE: **(-10° +40°)**

\* Lumen nominali LED max a 25° | Nominal lumen at max 25°

\*\* Potenza dei LED | LED power

\*\*\* Flusso totale in uscita dall'apparecchio a temperatura di lavoro (Ta 25° - 4.000 K) | Total lighting fitting flux output at working temperature (Ta 25° - 4.000 K) | (3.000 K -8% - CRI 90 -10%)

Fotometrie | Photometries  
p. 89

Schema di cablaggio | Connection scheme  
p. XXVIII-XXIX

Descrizione prodotto | Product description  
p. 88



 Caratteristiche Meccaniche | *Mechanical Features*

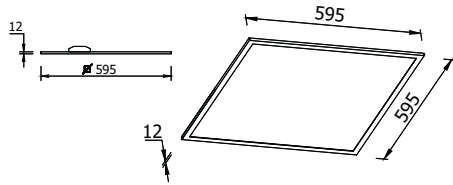

Alimentatore incluso non integrato all'interno dell'apparecchio.  
Power supply included not integrated inside the appliance.



Particolare telaio in alluminio estruso  
Detail of extruded aluminum frame

 Accessori | *Accessories*

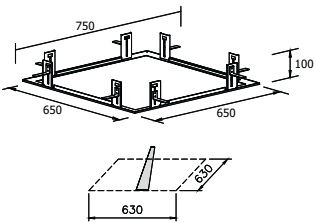
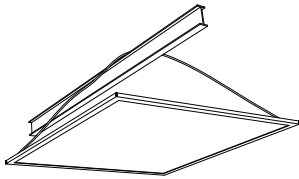
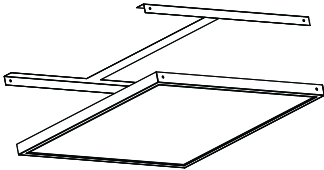
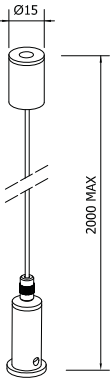
DESCRIZIONE ACCESSORIO ACCESSORY DESCRIPTION	CODICE CODE	
	<p>False ceiling frame. Telaio per controsoffitti.</p>	<p><b>TLC3</b></p>
	<p>Security cable Cavo di sicurezza</p>	<p><b>ADKTS01</b></p>
	<p>Frame for ceiling installation Telaio plafone</p>	<p><b>ADKP01</b></p>
	<p><b>n. 4 cavi d'acciaio</b> L=2000 mm n. 4 perni regolazione millimetrica n. 4 rosoni cilindrici</p> <p><b>no. 4 steel cables</b> L=2000 mm no. 4 precision adjustment pins no. 4 cylindrical ceiling roses</p>	<p><b>KT10440</b></p>





Performance illuminotecniche nettamente superiori all'attuale generazione di lampade LED.

*Lighting performance definitely higher compared to the others LED fixtures in the market nowadays.*





## INCASSO DOWNLIGHT RECESSED DOWNLIGHT

Sistema di apparecchi illuminotecnici LED ad incasso per il terziario e retail.  
*LED recessed lighting fittings system for services and retail.*



# GAMMA PRODOTTI | PRODUCT RANGE

## INCASSO DOWNLIGHT RECESSED DOWNLIGHT



### CLOCK LED S-T-MP Ø 230

p. 120-121-122

Anello di finitura in lamiera d'acciaio verniciata con polveri epossidiche previa fosfatazione. Dissipatore in alluminio estruso ed anodizzato. Ottica in alluminio anodizzato con trattamento di metallizzazione in alto vuoto. Schermo di chiusura in vetro sabbato (cod. S), in vetro trasparente (cod. T) in policarbonato microprismato (cod. MP). Installazione ad incasso tramite molle (per controsoffitti con spessore da 5mm a 30mm). Sorgente luminosa LED. Emissione diretta. Non idonea per l'applicazione esterna. Alimentazione elettronica CAE. A richiesta: dimmerabile DALI (cod. DL) specificare se con funzione PUSH DIM (cod. PD).

*Steel sheet finishing ring painted with epoxy powders after phosphating. Extruded and anodized aluminum heatsink. Polished metallized and anodized aluminum louver. Sandblasted glass closing diffuser (code S), transparent glass (code T) or opal polycarbonate (code MP). Recessed mounting by means of springs (for false ceilings from 5mm to 30mm thickness). LED Light source. Direct light emission. Not suitable for outdoor application. Built-in electronic driver CAE. On request: dimmable DALI (code DL) PUSH DIM function (code PD) to be requested.*



### NEW REMISI S-M Ø 230 - Ø 200

p. 124-125-126-127

Anello di finitura in lamiera d'acciaio verniciata con polveri epossidiche previa fosfatazione. Dissipatore in alluminio estruso ed anodizzato. Ottica in alluminio metallizzata in alto vuoto speculare (cod. M) o in alluminio satinato (cod. S). Schermo di chiusura in policarbonato opale antiabbagliamento. Installazione ad incasso tramite molle (per controsoffitti con spessore da 5mm a 30mm). Sorgente luminosa LED. Emissione diretta. Non idonea per l'applicazione esterna. Alimentazione elettronica CAE. A richiesta: dimmerabile DALI (cod. DL) specificare se con funzione PUSH DIM (cod. PD).

*Steel sheet finishing ring painted with epoxy powders after phosphating. Extruded and anodized aluminum heatsink. Polished metallized aluminum louver (code M) or aluminum satin louver (code S). Opal polycarbonate anti-glare closing diffuser. Recessed mounting by mean of springs (for false ceilings from 5mm to 30mm thickness). LED light source. Direct light emission. Not suitable for outdoor application. Built-in electronic driver CAE. On request: dimmable DALI (code DL) PUSH DIM function (code PD) to be requested.*



### DORIA VS Ø 230 - Ø 190

p. 128-129

Anello di finitura in lamiera d'acciaio verniciata con polveri epossidiche previa fosfatazione. Dissipatore in alluminio estruso ed anodizzato. Ottica in alluminio metallizzata in alto vuoto speculare. Schermo di chiusura in vetro sabbato (Cod. VS). Installazione ad incasso tramite molle (per controsoffitti con spessore da 5mm a 30mm). Sorgente luminosa LED. Emissione diretta. Non idonea per l'applicazione esterna. Alimentazione elettronica CAE. A richiesta: dimmerabile DALI (cod. DL) specificare se con funzione PUSH DIM (cod. PD).

*Steel sheet finishing ring painted with epoxy powders after phosphating. Extruded and anodized aluminum heatsink. Polished metallized aluminum louver. Sandblasted glass closing diffuser (code VS). Recessed mounting by mean of springs (for false ceilings from 5 mm to 30mm thickness). LED light source. Direct light emission. Not suitable for outdoor application. Built-in electronic driver CAE. On request: dimmable DALI (code DL) PUSH DIM function (code PD) to be requested.*

# FOTOMETRIE | PHOTOMETRIES

## INCASSO DOWNLIGHT RECESSED DOWNLIGHT

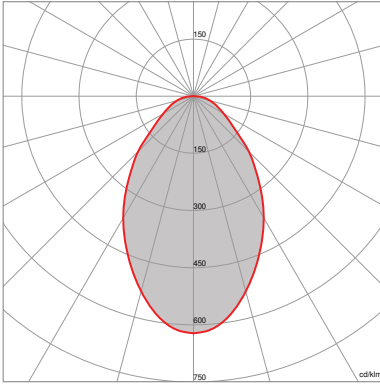

**CLOCK LED S**

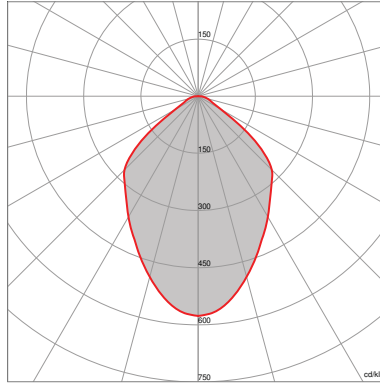

**CLOCK LED T**

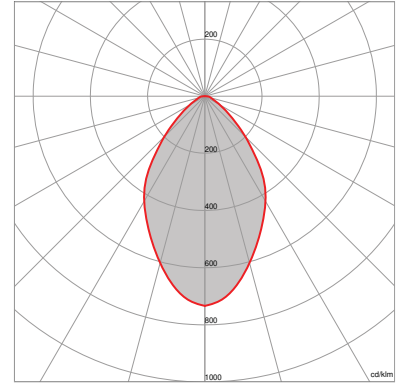

**CLOCK LED MP**

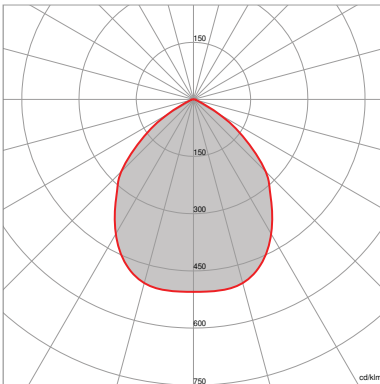

**NEW REMISI 230 S**

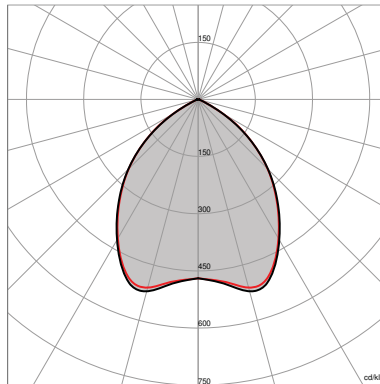

**NEW REMISI 230 M**

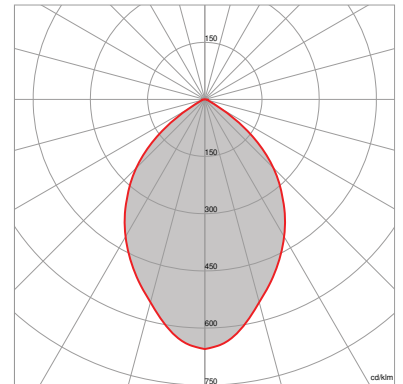

**NEW REMISI 200 S**

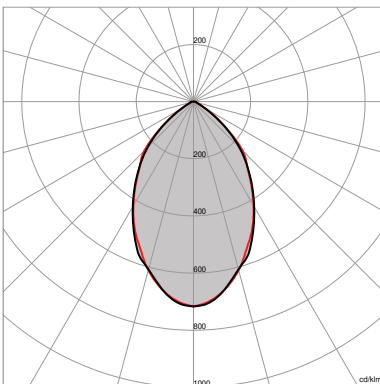

**NEW REMISI 200 M**

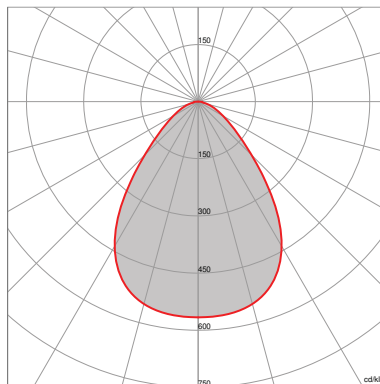

**DORIA 230 VS**

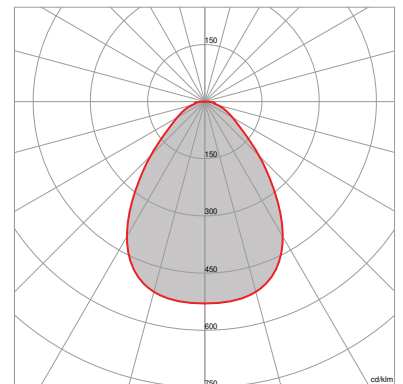

**DORIA 190 VS**



Rimani aggiornato  
Keep up to date



# GAMMA PRODOTTI | PRODUCT RANGE

## INCASSO DOWNLIGHT RECESSED DOWNLIGHT



### SPOTLED 200X200 mm

p. 130-131

Corpo in lamiera d'acciaio pressopiegata verniciata con polveri epossidiche previa fosfatazione. Telaio in pressofusione di alluminio. Riflettore in alluminio speculare ad alto rendimento. Dissipatore in alluminio estruso ed anodizzato. Schermo di chiusura in policarbonato opale (Cod. OP) o microprismato (Cod. MP). Installazione ad incasso tramite molle (per controsoffitti con spessore da 5mm a 30mm). Sorgente luminosa LED. Emissione diretta. Non idonea per l'applicazione esterna. Alimentazione elettronica CAE. A richiesta: dimmerabile DALI (cod. DL) specificare se con funzione PUSH DIM (cod. PD).

*Bent steel sheet body painted with epoxy powders after phosphating. Die-cast aluminum frame. High performance aluminum reflector. Extruded anodized aluminum heatsink. Opal (Code OP) or microprismatic (Code MP) polycarbonate closing diffuser. Recessed mounting by mean of springs (for false ceilings from 5mm to 30mm thickness). LED light source. Direct light emission. Not suitable for outdoor application. Built-in electronic driver CAE. On request: dimmable DALI (code DL) PUSH DIM function (code PD) to be requested.*

### INCA Ø 150 - Ø 125

p. 132-133



Anello di finitura in lamiera d'acciaio verniciata con polveri epossidiche previa fosfatazione. Ottica in alluminio anodizzato con trattamento di metallizzazione in alto vuoto. Schermo di chiusura in policarbonato opale. Installazione ad incasso tramite molle (per controsoffitti con spessore da 5mm a 30mm). Sorgente luminosa LED. Emissione diretta. Non idonea per l'applicazione esterna. Alimentazione elettronica CAE. A richiesta: dimmerabile DALI (cod. DL) specificare se con funzione PUSH DIM (cod. PD).

*Steel sheet finishing ring painted with epoxy powders after phosphating. Polished anodized and metallized aluminum louver. Opal polycarbonate anti-glare closing diffuser. Recessed mounting by mean of springs (for false ceilings from 5mm to 30mm thickness). LED light source. Direct light emission. Not suitable for outdoor application. Built-in electronic driver CAE. On request: dimmable DALI (code DL) PUSH DIM function (code PD) to be requested.*

### NEW WHITE Ø 230 - Ø 200 - Ø 150

p. 134-135-136



Corpo e riflettore in un unico pezzo in alluminio verniciato con polveri epossidiche previa fosfatazione. Schermo di chiusura in policarbonato opale antiabbagliamento. Installazione ad incasso tramite molle (per controsoffitti con spessore da 5 mm a 30 mm). Sorgente luminosa LED. Emissione diretta.

*One piece aluminum body reflector, painted with epoxy powders after phosphating. Opal polycarbonate anti-glare closing diffuser. Recessed mounting by mean of springs (for false ceiling from 5 mm to 30 mm thickness). LED light source. Direct light emission.*

### ENNE

p. 137



Corpo e parabola in alluminio tornito, verniciato con polvere epossidica previa fosfatazione. Dissipatore in alluminio anodizzato nero. Fornito completo di molle per installazione senza utensili. Ottica in PMMA (ST "stretto" - MD "medio").

*Turned aluminum body and reflector painted with epoxy powders after phosphating. Black anodized extruded aluminum heat sink. Complete with springs for installation without using of tools. PMMA optic, (ST "narrow" - MD "medium").*

### SII

p. 138



Corpo in alluminio tornito, verniciato con polvere epossidica previa fosfatazione. Parabola in alluminio sfaccettato anodizzato. Dissipatore in alluminio anodizzato nero. Fornito completo di molle per installazione senza utensili. Ottica in PMMA (ST "stretto" - MD "medio").

*Turned aluminum body and reflector painted with epoxy powders after phosphating. Black anodized extruded aluminum heat sink. Complete with springs for installation without using of tools. PMMA optic, (ST "narrow" - MD "medium").*

# FOTOMETRIE | PHOTOMETRIES

## INCASSO DOWNLIGHT RECESSED DOWNLIGHT

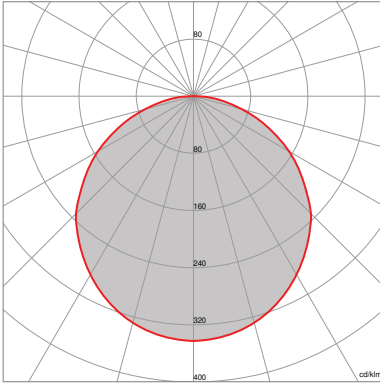

**SPOTLED OP**

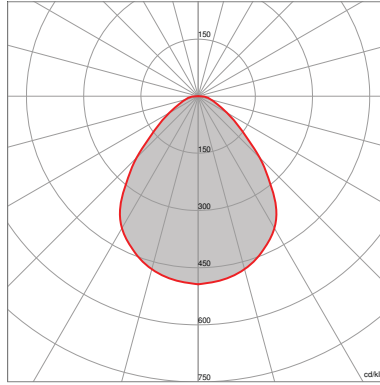

**SPOTLED MP**

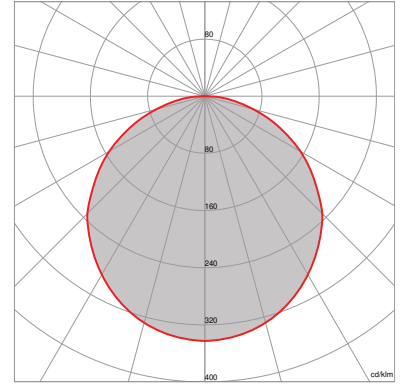

**INCA 150**

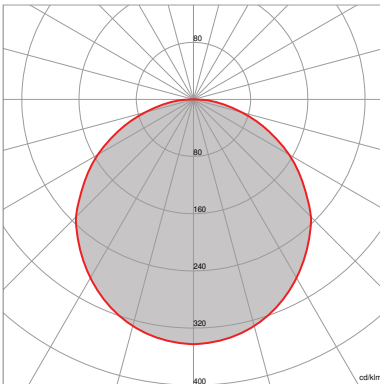

**INCA 125**

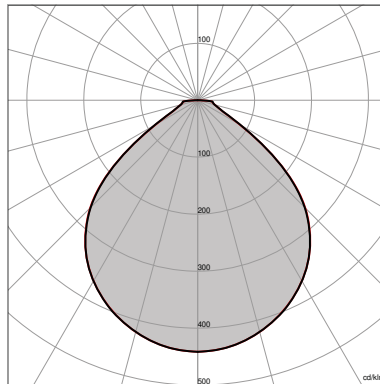

**NEW WHITE 230-200-150**

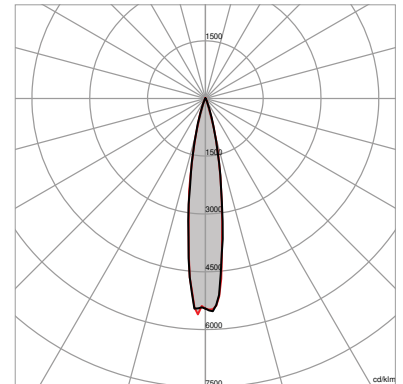

**ENNE**  
Fascio/Beam | ST

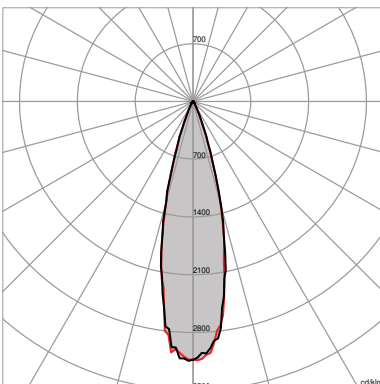

**ENNE**  
Fascio/Beam | MD

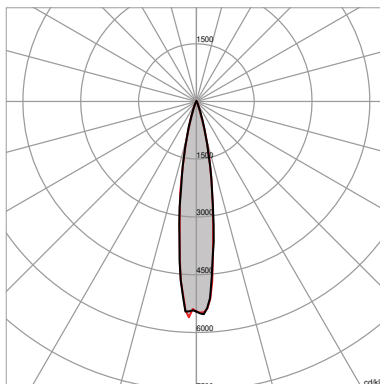

**SII**  
Fascio/Beam | ST

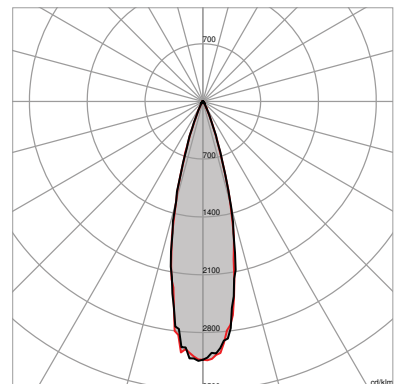

**SII**  
Fascio/Beam | MD



Rimani aggiornato  
Keep up to date



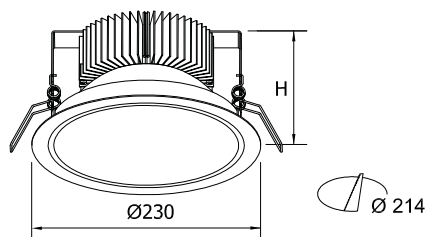

# CLOCK LED S

## SABBIATO/SANDBLASTED

Schermo di chiusura in vetro sabbiato (Codice S).  
Sandblasted closing diffuser (Code S).



A RICHIESTA | ON REQUEST

**5Y WARRANTY**  
5% FAILURE RATE

**60.000 h**  
LED LIFETIME L90B10

**100.000 h**  
LED LIFETIME L70B50

**>90**  
CRI

**EM**  
EN 60970-2-22

**DL**  
DALI

**PD**  
PUSH DIM

Relamping	Lumen LED*	Watt LED**	Lumen Out***	Watt	Lumen Watt Out	mA	H Altezza H Height	Codice Code	Ottica Optic	K	Alimentazione Power Supply	Colore Colour
2x26	<b>2930</b>	18,5	2300	19,5	> 118	450	70 mm •	<b>CLK19</b>	S: sabbiato sandblasted	W: 3.000 N: 4.000	— : CAE A RICHIESTA   ON REQUEST DL: DALI PD: PUSH DIM	01: bianco white
2x32	<b>3220</b>	20	2530	21,5	> 117	500	70 mm •	<b>CLK23</b>				
2x42	<b>3840</b>	25	3025	26,5	> 114	600	110 mm •	<b>CLK28</b>				
1x70	<b>4400</b>	29	3465	30,5	> 114	700	110 mm •	<b>CLK33</b>				
1x100	<b>5540</b>	37,5	4365	39,5	> 110	900	160 mm •	<b>CLK43</b>				
<150	<b>6350</b>	43	5115	45,5	> 112	1050	160 mm •	<b>CLK51</b>				



A richiesta | On request

TEMPERATURA AMBIENTE MIN E MAX | MIN AND MAX ROOM TEMPERATURE: (-10° +40°)

\* Lumen nominali LED max a 25° | Nominal lumen at max 25°

\*\* Potenza dei LED | LED power

\*\*\* Flusso totale in uscita dall'apparecchio a temperatura di lavoro (Ta 25° - 4.000 K) | Total lighting fitting flux output at working temperature (Ta 25° - 4.000 K) | (3.000 K -8% - CRI 90 -10%)

- H 70 mm: autodissipato | Self dissipated
- H 110 mm - H 160 mm: con dissipatore in alluminio | with aluminium heat sink

#### A RICHIESTA / ON REQUEST

- Anello di compensazione, misura su richiesta | Compensation ring, dimension on request
- È possibile utilizzare COB con caratteristiche cromatiche **specifiche: RETAIL & FOOD** - Carne, pesce, pane, frutta e verdura | **SHOP & STYLE** - CrispWhite, CrispColor, True color | Possibility to use cob with **specific chromatic characteristics: RETAIL & FOOD** - Meat, fish, bread, fruit&veg | **SHOP & STYLE** - CrispWhite, CrispColor, True color

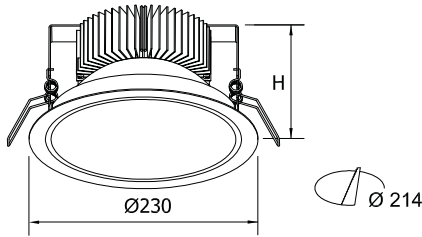

# CLOCK LED T TRASPARENTE/TRANSPARENT

Schermo di chiusura trasparente serigrafato (Codice T).  
Transparent glass closing diffuser (Code T).



A RICHIESTA | ON REQUEST

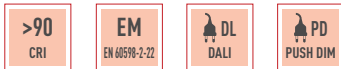

**5Y WARRANTY**  
5% FAILURE RATE

**60.000 h**  
LED LIFETIME L90B10

**100.000 h**  
LED LIFETIME L70B50

Relamping	Lumen LED*	Watt LED**	Lumen Out***	Watt	Lumen Watt Out	mA	H Altezza H Height	Codice Code	Ottica Optic	K	Alimentazione Power Supply	Colore Colour
2x32	<b>2930</b>	18,5	2820	19,5	> 144	450	70 mm •	<b>CLK19</b>	T: trasparente transparent	W: 3.000 N: 4.000	— : CAE A RICHIESTA   ON REQUEST DL: DALI PD: PUSH DIM	01: bianco white
2x42	<b>3220</b>	20	3090	21,5	> 144	500	70 mm •	<b>CLK23</b>				
1x70	<b>3840</b>	25	3690	26,5	> 139	600	110 mm •	<b>CLK28</b>				
1x100	<b>4400</b>	29	4230	30,5	> 139	700	110 mm •	<b>CLK33</b>				
<150	<b>5540</b>	37,5	5325	39,5	> 134	900	160 mm •	<b>CLK43</b>				
1x150	<b>6350</b>	43	6105	45,5	> 134	1050	160 mm •	<b>CLK51</b>				



A richiesta | On request

TEMPERATURA AMBIENTE MIN E MAX | MIN AND MAX ROOM TEMPERATURE: (-10° +40°)

\* Lumen nominali LED max a 25° | Nominal lumen at max 25°

\*\* Potenza dei LED | LED power

\*\*\* Flusso totale in uscita dall'apparecchio a temperatura di lavoro (Ta 25° - 4.000 K) | Total lighting fitting flux output at working temperature (Ta 25° - 4.000 K) | (3.000 K -8% - CRI 90 -10%)

- H 70 mm: autodissipato | Self dissipated
- H 110 mm - H 160 mm: con dissipatore in alluminio | with aluminium heat sink

**A RICHIESTA / ON REQUEST**

- Anello di compensazione, misura su richiesta | Compensation ring, dimension on request
- È possibile utilizzare COB con caratteristiche cromatiche **specifiche: RETAIL & FOOD** - Carne, pesce, pane, frutta e verdura | **SHOP & STYLE** - CrispWhite, CrispColor, True color | Possibility to use cob with **specific** chromatic characteristics: **RETAIL & FOOD** - Meat, fish, bread, fruit&veg | **SHOP & STYLE** - CrispWhite, CrispColor, True color

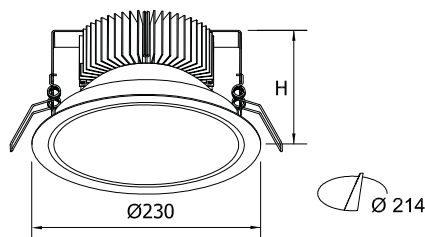

# CLOCK LED MP MICROPRISMATO/MICROPRISMATIC

Schermo di chiusura in policarbonato microprismato (Codice MP).  
Microprismatic polycarbonate closing diffuser (Code MP).



A RICHIESTA | ON REQUEST

<b>5Y WARRANTY</b> 5% FAILURE RATE	<b>60.000 h</b> LED LIFETIME L90B10	<b>100.000 h</b> LED LIFETIME L70B50
---------------------------------------	--	---

>90 CRI	EM EN 60598-2-22	DL DALI	PD PUSH DIM
------------	---------------------	------------	----------------

Relamping	Lumen LED*	Watt LED**	Lumen Out***	Watt	Lumen Watt Out	mA	H Altezza H Height	Codice Code	Ottica Optic	K	Alimentazione Power Supply	Colore Colour
2x26	<b>2930</b>	18,5	2290	19,5	> 117	450	70 mm •	<b>CLK19</b>	MP: microprismato microprismatic	W: 3.000 N: 4.000	— : CAE A RICHIESTA   ON REQUEST DL: DALI PD: PUSH DIM	01: bianco white
2x32	<b>3220</b>	20	2515	21,5	> 117	500	70 mm •	<b>CLK23</b>				
2x42	<b>3840</b>	25	3010	26,5	> 113	600	110 mm •	<b>CLK28</b>				
1x70	<b>4400</b>	29	3445	30,5	> 113	700	110 mm •	<b>CLK33</b>				
1x100	<b>5540</b>	37,5	4340	39,5	> 110	900	160 mm •	<b>CLK43</b>				
<150	<b>6350</b>	43	5085	45,5	> 111	1050	160 mm •	<b>CLK51</b>				

CE	IP44 EN 60529	230 V 2014/35/UE	50/60 Hz	IK 07 EN 60068
----	------------------	---------------------	-------------	-------------------

850° EN 60695	A++ A+	RG 0 EN 62471	01 WHITE	19 UGR
------------------	-----------	------------------	-------------	-----------

02 BLACK	05 SILVER
-------------	--------------

A richiesta | On request

TEMPERATURA AMBIENTE MIN E MAX | MIN AND MAX ROOM TEMPERATURE: (-10° +40°)

\* Lumen nominali LED max a 25° | Nominal lumen at max 25°

\*\* Potenza dei LED | LED power

\*\*\* Flusso totale in uscita dall'apparecchio a temperatura di lavoro (Ta 25° - 4.000 K) | Total lighting fitting flux output at working temperature (Ta 25° - 4.000 K) | (3.000 K -8% - CRI 90 -10%)

- H 70 mm: autodissipato | Self dissipated
- H 110 mm - H 160 mm: con dissipatore in alluminio | with aluminium heat sink

#### A RICHIESTA / ON REQUEST

- Anello di compensazione, misura su richiesta | Compensation ring, dimension on request
- È possibile utilizzare COB con caratteristiche cromatiche **specifiche: RETAIL & FOOD** - Carne, pesce, pane, frutta e verdura | **SHOP & STYLE** - CrispWhite, CrispColor, True color | Possibility to use cob with **specific** chromatic characteristics: **RETAIL & FOOD** - Meat, fish, bread, fruit&veg | **SHOP & STYLE** - CrispWhite, CrispColor, True color



**NEGOZIO/SHOWROOM BENETTON | ITALIA**



**NEGOZIO/SHOWROOM BENETTON | ITALIA**



**AUTOSALONE/SHOWROOM | CALABRIA**



**NEGOZIO/SHOWROOM BENETTON | ITALIA**



**AUTOSALONE/SHOWROOM | REPUBBLICA CECA**



**CASA PRIVATA/PRIVATE HOUSE | ITALIA**

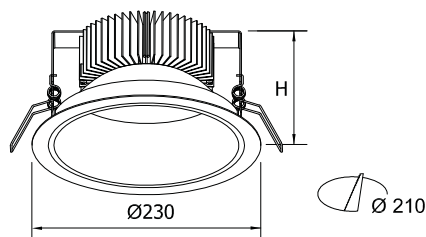

# NEW REMISI 230

## SATINATO/SATIN

Ottica in alluminio satinata (Codice S).  
Satin aluminum optic (Code S).



A RICHIESTA | ON REQUEST

<b>5Y WARRANTY</b> 5% FAILURE RATE	<b>60.000 h</b> LED LIFETIME L90B10	<b>100.000 h</b> LED LIFETIME L70B50
---------------------------------------	--	---

<b>&gt;90</b> CRI	<b>EM</b> EN 60598-2-22	<b>DL</b> DALI	<b>PD</b> PUSH DIM
----------------------	----------------------------	-------------------	-----------------------

Relamping	Lumen LED*	Watt LED**	Lumen Out***	Watt	Lumen Watt Out	mA	H Altezza H Height	Codice Code	Ottica Optic	K	Alimentazione Power Supply	Colore Colour
2x18	<b>2340</b>	14	2035	15,5	> 131	350	65 mm •	<b>NR233</b>	S: satinato satin	W: 3.000  N: 4.000	— : CAE  A RICHIESTA   ON REQUEST DL: DALI PD: PUSH DIM	01: bianco white
2x26	<b>2930</b>	18,5	2545	20	> 127	450	65 mm •	<b>NR234</b>				
2x32	<b>3220</b>	20	2795	22	> 127	500	65 mm •	<b>NR235</b>				
2x42	<b>3840</b>	25	3375	26,5	> 127	600	105 mm •	<b>NR236</b>				
1x70	<b>4400</b>	29	3880	30,5	> 127	700	105 mm •	<b>NR237</b>				
1x100	<b>5590</b>	37,5	4855	41	> 118	900	155 mm •	<b>NR238</b>				
<150	<b>6350</b>	43	5510	47	> 117	1050	155 mm •	<b>NR239</b>				

CE		<b>&gt;80</b> CRI	<b>IP44</b> EN 60529	<b>230 V</b> 2014/35/UE	<b>50/60</b> Hz	<b>IK 07</b> EN 60068
----	--	----------------------	-------------------------	----------------------------	--------------------	--------------------------

<b>850°</b> EN 60695		<b>RG 0</b> EN 62471		<b>01</b> WHITE	<b>19</b> UGR
-------------------------	--	-------------------------	--	--------------------	------------------

<b>02</b> BLACK	<b>05</b> SILVER	<b>IP55</b> EN 60529
--------------------	---------------------	-------------------------

A richiesta | On request

TEMPERATURA AMBIENTE MIN E MAX | MIN AND MAX ROOM TEMPERATURE: (-10° +40°)

\* Lumen nominali LED max a 25° | Nominal lumen at max 25°

\*\* Potenza dei LED | LED power

\*\*\* Flusso totale in uscita dall'apparecchio a temperatura di lavoro (Ta 25° - 4.000 K) | Total lighting fitting flux output at working temperature (Ta 25° - 4.000 K) | (3.000 K -8% - CRI 90 -10%)

- H 65 mm: autodissipato | Self dissipated
- H 105 mm - H 155 mm: con dissipatore in alluminio | with aluminium heat sink

#### A RICHIESTA / ON REQUEST

- Anello di compensazione, misura su richiesta | Compensation ring, dimension on request
- È possibile utilizzare COB con caratteristiche cromatiche **specifiche: RETAIL & FOOD** - Carne, pesce, pane, frutta e verdura | **SHOP & STYLE** - CrispWhite, CrispColor, True color | Possibility to use cob with **specific** chromatic characteristics: **RETAIL & FOOD** - Meat, fish, bread, fruit&veg | **SHOP & STYLE** - CrispWhite, CrispColor, True color

Fotometrie | Photometries  
p. 117



Schema di cablaggio | Connection scheme  
p. XXVIII-XXIX



Descrizione prodotto | Product description  
p. 116

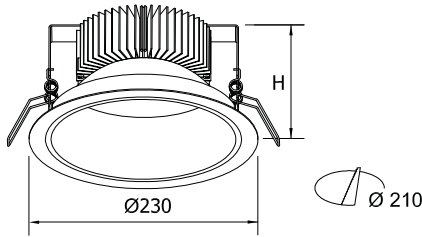

# NEW REMISI 230 METALLIZZATO/METALLIZED

Ottica in alluminio metallizzato speculare (Codice M).  
Polished metallized aluminum optic (Code M).



A RICHIESTA | ON REQUEST

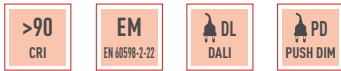

Relamping	Lumen LED*	Watt LED**	Lumen Out***	Watt	Lumen Watt Out	mA	H Altezza H Height	Codice Code	Ottica Optic	K	Alimentazione Power Supply	Colore Colour
2x18	<b>2340</b>	14	2035	15,5	> 131	350	65 mm •	<b>NR233</b>	M: metallizzato metallized	W: 3.000 N: 4.000	— : CAE A RICHIESTA   ON REQUEST DL: DALI PD: PUSH DIM	01: bianco white
2x26	<b>2930</b>	18,5	2545	20	> 127	450	65 mm •	<b>NR234</b>				
2x32	<b>3220</b>	20	2795	22	> 127	500	65 mm •	<b>NR235</b>				
2x42	<b>3840</b>	25	3375	26,5	> 127	600	105 mm •	<b>NR236</b>				
1x70	<b>4400</b>	29	3880	30,5	> 127	700	105 mm •	<b>NR237</b>				
1x100	<b>5590</b>	37,5	4855	41	> 118	900	155 mm •	<b>NR238</b>				
<150	<b>6350</b>	43	5510	47	> 117	1050	155 mm •	<b>NR239</b>				

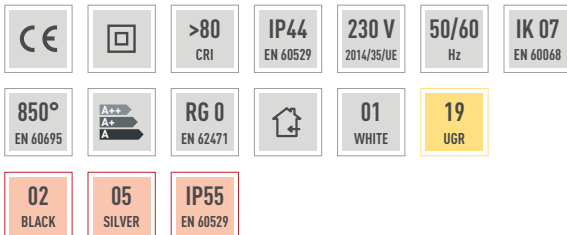

A richiesta | On request

TEMPERATURA AMBIENTE MIN E MAX | MIN AND MAX ROOM TEMPERATURE: (-10° +40°)

\* Lumen nominali LED max a 25° | Nominal lumen at max 25°

\*\* Potenza dei LED | LED power

\*\*\* Flusso totale in uscita dall'apparecchio a temperatura di lavoro (Ta 25° - 4.000 K) | Total lighting fitting flux output at working temperature (Ta 25° - 4.000 K) | (3.000 K -8% - CRI 90 -10%)

- H 65 mm: autodissipato | Self dissipated
- H 105 mm - H 155 mm: con dissipatore in alluminio | with aluminium heat sink

**A RICHIESTA / ON REQUEST**

- Anello di compensazione, misura su richiesta | Compensation ring, dimension on request
- È possibile utilizzare COB con caratteristiche cromatiche specifiche: **RETAIL & FOOD** - Carne, pesce, pane, frutta e verdura | **SHOP & STYLE** - CrispWhite, CrispColor, True color | Possibility to use cob with specific chromatic characteristics: **RETAIL & FOOD** - Meat, fish, bread, fruit&veg | **SHOP & STYLE** - CrispWhite, CrispColor, True color



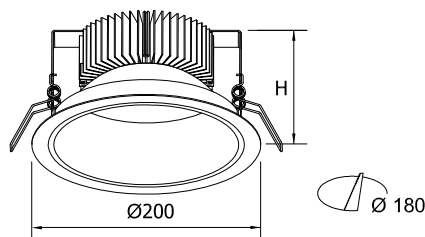

# NEW REMISI 200 SATINATO/SATIN

Ottica in alluminio satinata (Codice S)  
Satin aluminum optic (Code S)



A RICHIESTA | ON REQUEST

<b>5Y WARRANTY</b> 5% FAILURE RATE	<b>60.000 h</b> LED LIFETIME L90B10	<b>100.000 h</b> LED LIFETIME L70B50
---------------------------------------	--	---

>90 CRI	EM EN 60598-2-22	DL DALI	PD PUSH DIM
------------	---------------------	------------	----------------

Relamping	Lumen LED*	Watt LED**	Lumen Out***	Watt	Lumen Watt Out	mA	H Altezza H Height	Codice Code	Ottica Optic	K	Alimentazione Power Supply	Colore Colour
1x13	<b>1270</b>	7,5	1085	8	> 135	180	65 mm •	<b>NR201</b>	S: satinato satin	W: 3.000  N: 4.000	— : CAE  A RICHIESTA   ON REQUEST DL: DALI PD: PUSH DIM	01: bianco white
2x13	<b>1740</b>	10,5	1465	11	> 133	250	65 mm •	<b>NR202</b>				
1x18	<b>2340</b>	14	1975	15,5	> 127	350	65 mm •	<b>NR203</b>				
2x26	<b>2930</b>	20	2470	18,5	> 133	450	65 mm •	<b>NR204</b>				
2x32	<b>3220</b>	20	2710	22	> 123	500	65 mm •	<b>NR205</b>				
2x42	<b>3840</b>	25	3275	26,5	> 123	600	105 mm •	<b>NR206</b>				
1x70	<b>4400</b>	29	3765	30,5	> 123	700	105 mm •	<b>NR207</b>				

CE	850° EN 60695	>80 CRI	A++ A	IP44 EN 60529	RG 0 EN 62471	230 V 2014/35/UE	50/60 Hz	IK 07 EN 60068	01 WHITE	19 UGR	02 BLACK	05 SILVER	IP55 EN 60529
----	------------------	------------	----------	------------------	------------------	---------------------	-------------	-------------------	-------------	-----------	-------------	--------------	------------------

A richiesta | On request

TEMPERATURA AMBIENTE MIN E MAX | MIN AND MAX ROOM TEMPERATURE: -10° +40°

\* Lumen nominali LED max a 25° | Nominal lumen at max 25°

\*\* Potenza dei LED | LED power

\*\*\* Flusso totale in uscita dall'apparecchio a temperatura di lavoro (Ta 25° - 4.000 K) | Total lighting fitting flux output at working temperature (Ta 25° - 4.000 K) | (3.000 K -8% - CRI 90 -10%)

- H 65 mm: autodissipato | Self dissipated
- H 105 mm - H 155 mm: con dissipatore in alluminio | with aluminium heat sink

**A RICHIESTA / ON REQUEST**

- Anello di compensazione, misura su richiesta | Compensation ring, dimension on request
- È possibile utilizzare COB con caratteristiche cromatiche specifiche: **RETAIL & FOOD** - Carne, pesce, pane, frutta e verdura | **SHOP & STYLE** - CrispWhite, CrispColor, True color | Possibility to use cob with specific chromatic characteristics: **RETAIL & FOOD** - Meat, fish, bread, fruit&veg | **SHOP & STYLE** - CrispWhite, CrispColor, True color



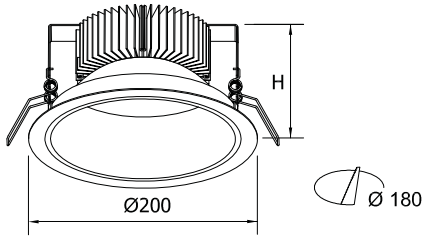

# NEW REMISI 200 METALLIZZATO/METALLIZED

Ottica in alluminio metallizzato speculare (Codice M)  
Polished metallized aluminum optic (Code M)



A RICHIESTA | ON REQUEST



Relamping	Lumen LED*	Watt LED**	Lumen Out***	Watt	Lumen Watt Out	mA	H Altezza H Height	Codice Code	Ottica Optic	K	Alimentazione Power Supply	Colore Colour
1x13	1270	7,5	1085	8	> 135	180	65 mm •	NR201	M: metallizzato metallized	W: 3.000 N: 4.000	— : CAE A RICHIESTA   ON REQUEST DL: DALI PD: PUSH DIM	01: bianco white
2x13	1740	10,5	1465	11	> 133	250	65 mm •	NR202				
1x18	2340	14	1975	15,5	> 127	350	65 mm •	NR203				
2x26	2930	20	2470	18,5	> 133	450	65 mm •	NR204				
2x32	3220	20	2710	22	> 123	500	65 mm •	NR205				
2x42	3840	25	3275	26,5	> 123	600	105 mm •	NR206				
1x70	4400	29	3765	30,5	> 123	700	105 mm •	NR207				



A richiesta | On request

TEMPERATURA AMBIENTE MIN E MAX | MIN AND MAX ROOM TEMPERATURE: (-10° +40°)

\* Lumen nominali LED max a 25° | Nominal lumen at max 25°

\*\* Potenza dei LED | LED power

\*\*\* Flusso totale in uscita dall'apparecchio a temperatura di lavoro (Ta 25° - 4.000 K) | Total lighting fitting flux output at working temperature (Ta 25° - 4.000 K) | (3.000 K -8% - CRI 90 -10%)

- H 65 mm: autodissipato | Self dissipated
- H 105 mm: con dissipatore in alluminio | with aluminium heat sink

A RICHIESTA / ON REQUEST

- Anello di compensazione, misura su richiesta | Compensation ring, dimension on request
- È possibile utilizzare COB con caratteristiche cromatiche specifiche: **RETAIL & FOOD** - Carne, pesce, pane, frutta e verdura | **SHOP & STYLE** - CrispWhite, CrispColor, True color | Possibility to use cob with specific chromatic characteristics: **RETAIL & FOOD** - Meat, fish, bread, fruit&veg | **SHOP & STYLE** - CrispWhite, CrispColor, True color

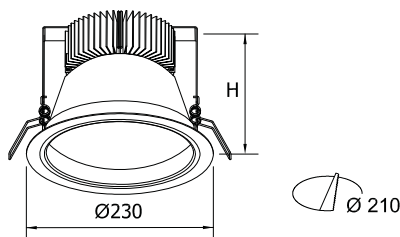

# DORIA 230

## VETRO SABBBIATO/SANDBLASTED GLASS

Schermo di chiusura in vetro sabbbiato ( Codice VS).  
Sandblasted glass closing diffuser (Code VS).



A RICHIESTA | ON REQUEST

<b>5Y WARRANTY</b> 5% FAILURE RATE	<b>60.000 h</b> LED LIFETIME L90B10	<b>100.000 h</b> LED LIFETIME L70B50
---------------------------------------	--	---

>90 CRI	EM EN 60970-2-22	DL DALI	PD PUSH DIM
------------	---------------------	------------	----------------

Relamping	Lumen LED*	Watt LED**	Lumen Out***	Watt	Lumen Watt Out	mA	H Altezza H Height	Codice Code	Ottica Optic	K	Alimentazione Power Supply	Colore Colour
2x18	<b>2340</b>	14	1575	15,5	> 105	350	110 mm •	<b>DR233</b>	VS: vetro sabbbiato Sandblasted glass	W: 3.000  N: 4.000	— : CAE  A RICHIESTA   ON REQUEST DL: DALI PD: PUSH DIM	01: bianco white
2x26	<b>2930</b>	18,5	1979	20	> 98	450	110 mm •	<b>DR234</b>				
2x32	<b>3220</b>	20	2165	22	> 98	500	110 mm •	<b>DR235</b>				
2x42	<b>3840</b>	25	2585	26,5	> 98	600	150 mm •	<b>DR236</b>				
1x70	<b>4400</b>	29	2955	30,5	> 98	700	150 mm •	<b>DR237</b>				
1x100	<b>5590</b>	37,5	3230	41	> 80	900	200 mm •	<b>DR238</b>				
<150	<b>6350</b>	43	4370	47	> 80	1050	200 mm •	<b>DR239</b>				

CE	850° EN 60695	>80 CRI	IP44 EN 60529	230 V 2014/35/UE	50/60 Hz	IK 07 EN 60068	RG 0 EN 62471	01 WHITE	19 UGR
02 BLACK	05 SILVER	IP55 EN 60529							

A richiesta | On request

TEMPERATURA AMBIENTE MIN E MAX | MIN AND MAX ROOM TEMPERATURE: (-10° +40°)

\* Lumen nominali LED max a 25° | Nominal lumen at max 25°

\*\* Potenza dei LED | LED power

\*\*\* Flusso totale in uscita dall'apparecchio a temperatura di lavoro (Ta 25° - 4.000 K) | Total lighting fitting flux output at working temperature (Ta 25° - 4.000 K) | (3.000 K -8% - CRI 90 -10%)

- H 90 mm: autodissipato | Self dissipated
- H 130 mm - H 180 mm: con dissipatore in alluminio | with aluminium heat sink

#### A RICHIESTA / ON REQUEST

- Anello di compensazione, misura su richiesta | Compensation ring, dimension on request
- È possibile utilizzare COB con caratteristiche cromatiche **specifiche: RETAIL & FOOD** - Carne, pesce, pane, frutta e verdura | **SHOP & STYLE** - CrispWhite, CrispColor, True color | Possibility to use cob with **specific** chromatic characteristics: **RETAIL & FOOD** - Meat, fish, bread, fruit&veg | **SHOP & STYLE** - CrispWhite, CrispColor, True color

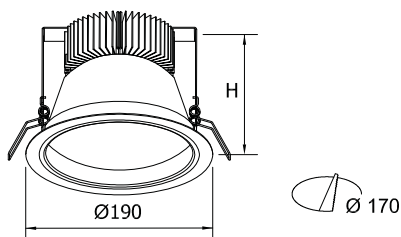

# DORIA 190

## VETRO SABBBIATO/SANDBLASTED GLASS

Schermo di chiusura in vetro sabbaiato (Codice VS).  
Sandblasted glass closing diffuser (Code VS).



A RICHIESTA | ON REQUEST



Relamping	Lumen LED*	Watt LED**	Lumen Out***	Watt	Lumen Watt Out	mA	H Altezza H Height	Codice Code	Ottica Optic	K	Alimentazione Power Supply	Colore Colour
1x18	1270	7,5	870	8	> 109	180	80 mm •	DR201	VS: vetro sabbaiato Sandblasted glass	W: 3.000 N: 4.000	— : CAE A RICHIESTA   ON REQUEST DL: DALI PD: PUSH DIM	01: bianco white
2x13	1740	10,5	1145	11	> 104	250	80 mm •	DR202				
2x18	2340	14	1520	15,5	> 100	350	80 mm •	DR203				
2x26	2930	20	1955	18,5	> 100	450	80 mm •	DR204				
2x32	3220	20	2150	22	> 100	500	120 mm •	DR205				
2x42	3840	25	2590	26,5	> 98	600	120 mm •	DR206				
1x70	4400	29	2950	30,5	> 96	700	120 mm •	DR207				

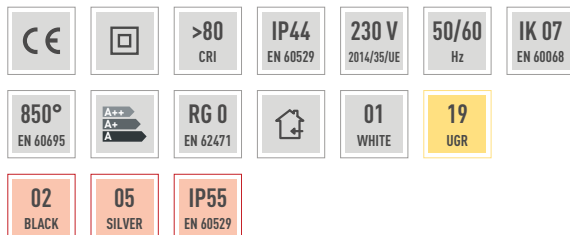

A richiesta | On request

TEMPERATURA AMBIENTE MIN E MAX | MIN AND MAX ROOM TEMPERATURE: (-10° +40°)

\* Lumen nominali LED max a 25° | Nominal lumen at max 25°

\*\* Potenza dei LED | LED power

\*\*\* Flusso totale in uscita dall'apparecchio a temperatura di lavoro (Ta 25° - 4.000 K) | Total lighting fitting flux output at working temperature (Ta 25° - 4.000 K) | (3.000 K -8% - CRI 90 -10%)

- H 80 mm: autodissipato | Self dissipated
- H 120 mm: con dissipatore in alluminio | with aluminium heat sink

**A RICHIESTA / ON REQUEST**

- Anello di compensazione, misura su richiesta | Compensation ring, dimension on request
- È possibile utilizzare COB con caratteristiche cromatiche specifiche: **RETAIL & FOOD** - Carne, pesce, pane, frutta e verdura | **SHOP & STYLE** - CrispWhite, CrispColor, True color | Possibilità to use cob with specific chromatic characteristics: **RETAIL & FOOD** - Meat, fish, bread, fruit&veg | **SHOP & STYLE** - CrispWhite, CrispColor, True color

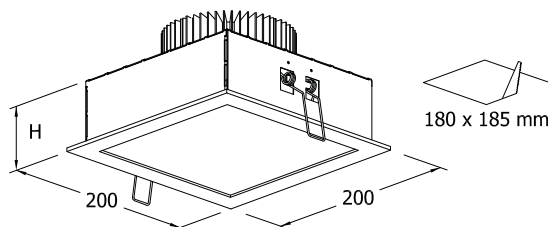
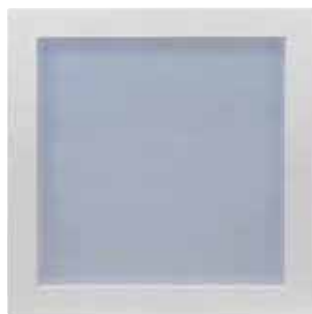

# SPOTLED OP

## OPALE/OPAL

Schermo di chiusura in policarbonato opale (Codice OP).  
Opal polycarbonate closing diffuser (Code OP).



A RICHIESTA | ON REQUEST

**5Y WARRANTY**  
5% FAILURE RATE

**60.000 h**  
LED LIFETIME L90B10

**100.000 h**  
LED LIFETIME L70B50

**>90**  
CRI

**EM**  
EN 60970-2-22

**DL**  
DALI

**PD**  
PUSH DIM

Relamping	Lumen LED*	Watt LED**	Lumen Out***	Watt	Lumen Watt Out	mA	H Altezza H Height	Codice Code	Ottica Optic	K	Alimentazione Power Supply	Colore Colour
2x18	<b>2340</b>	14	1530	15,5	> 99	350	70 mm •	<b>SP3</b>	OP: opale opal	W: 3.000  N: 4.000	— : CAE  A RICHIESTA   ON REQUEST <b>DL</b> : DALI <b>PD</b> : PUSH DIM	<b>01</b> : bianco white
2x26	<b>2930</b>	18,5	1910	20	> 96	450	70 mm •	<b>SP4</b>				
2x32	<b>3220</b>	20	2100	22	> 96	500	70 mm •	<b>SP5</b>				
2x42	<b>3840</b>	25	2510	26,5	> 96	600	110 mm •	<b>SP6</b>				
1x70	<b>4400</b>	29	2870	30,5	> 94	700	110 mm •	<b>SP7</b>				
1x100	<b>5590</b>	37,5	3620	39	> 92	900	150 mm •	<b>SP8</b>				
<150	<b>6350</b>	43	4240	47	> 91	1050	150 mm •	<b>SP9</b>				

CE

**>80**  
CRI

**IP44**  
EN 60529

**230 V**  
2014/35/UE

**50/60**  
Hz

**IK 07**  
EN 60068

**850°**  
EN 60695

**RG 0**  
EN 62471

**01**  
WHITE

**02**  
BLACK

**05**  
SILVER

**IP55**  
EN 60529

A richiesta | On request

TEMPERATURA AMBIENTE MIN E MAX | MIN AND MAX ROOM TEMPERATURE: (-10° +40°)

\* Lumen nominali LED max a 25° | Nominal lumen at max 25°

\*\* Potenza dei LED | LED power

\*\*\* Flusso totale in uscita dall'apparecchio a temperatura di lavoro (Ta 25° - 4.000 K) | Total lighting fitting flux output at working temperature (Ta 25° - 4.000 K) | (3.000 K -8% - CRI 90 -10%)

- H 70 mm: autodissipato | Self dissipated
- H 110 mm - H 150 mm: con dissipatore in alluminio | with aluminium heat sink

**A RICHIESTA / ON REQUEST**

- Anello di compensazione, misura su richiesta | Compensation ring, dimension on request
- È possibile utilizzare COB con caratteristiche cromatiche **specifiche: RETAIL & FOOD** - Carne, pesce, pane, frutta e verdura | **SHOP & STYLE** - CrispWhite, CrispColor, True color | Possibility to use cob with **specific** chromatic characteristics: **RETAIL & FOOD** - Meat, fish, bread, fruit&veg | **SHOP & STYLE** - CrispWhite, CrispColor, True color



Fotometrie | Photometries  
p. 119



Schema di cablaggio | Connection scheme  
p. XXVIII-XXIX



Descrizione prodotto | Product description  
p. 118

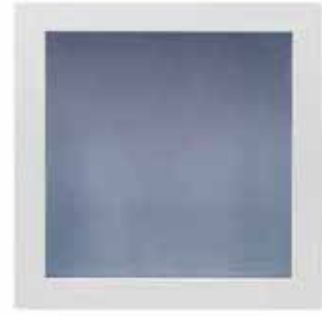
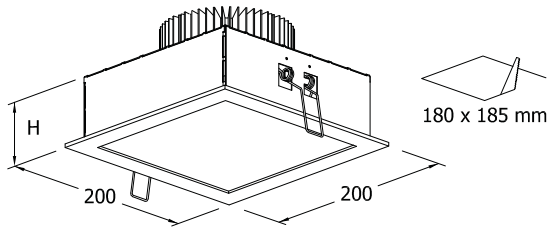

# SPOTLED MP MICROPRISMATO/MICROPRISMATIC

Schermo di chiusura in policarbonato microprismatico (Codice MP)  
Microprismatic polycarbonate closing diffuser (Code MP)



A RICHIESTA | ON REQUEST

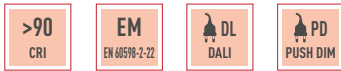

Relamping	Lumen LED*	Watt LED**	Lumen Out***	Watt	Lumen Watt Out	mA	H Altezza H Height	Codice Code	Ottica Optics	K	Alimentazione Power Supply	Colore Colour
2x18	<b>2340</b>	14	1790	15,5	> 115	350	70 mm •	<b>SP3</b>	MP: microprismatico microprismatic	W: 3.000 N: 4.000	— : CAE A RICHIESTA   ON REQUEST DL: DALI PD: PUSH DIM	01: bianco white
2x26	<b>2930</b>	18,5	2240	20	> 112	450	70 mm •	<b>SP4</b>				
2x32	<b>3220</b>	20	2460	22	> 112	500	70 mm •	<b>SP5</b>				
2x42	<b>3840</b>	25	2940	26,5	> 110	600	110 mm •	<b>SP6</b>				
1x70	<b>4400</b>	29	3365	30,5	> 110	700	110 mm •	<b>SP7</b>				
1x100	<b>5590</b>	37,5	4220	39	> 108	900	150 mm •	<b>SP8</b>				
<150	<b>6350</b>	43	4975	47	> 105	1050	150 mm •	<b>SP9</b>				

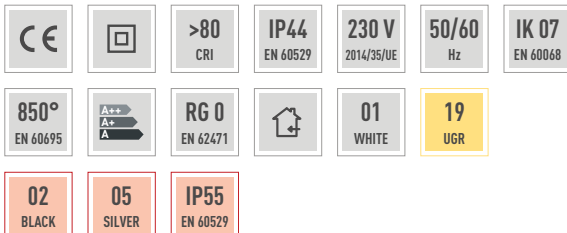

A richiesta | On request

TEMPERATURA AMBIENTE MIN E MAX | MIN AND MAX ROOM TEMPERATURE: (-10° +40°)

\* Lumen nominali LED max a 25° | Nominal lumen at max 25°

\*\* Potenza dei LED | LED power

\*\*\* Flusso totale in uscita dall'apparecchio a temperatura di lavoro (Ta 25° - 4.000 K) | Total lighting fitting flux output at working temperature (Ta 25° - 4.000 K) | (3.000 K -8% - CRI 90 -10%)

- H 70 mm: autodissipato | Self dissipated
- H 110 mm - H 150 mm: con dissipatore in alluminio | with aluminium heat sink

**A RICHIESTA / ON REQUEST**

- Anello di compensazione, misura su richiesta | Compensation ring, dimension on request
- È possibile utilizzare COB con caratteristiche cromatiche **specifiche: RETAIL & FOOD** - Carne, pesce, pane, frutta e verdura | **SHOP & STYLE** - CrispWhite, CrispColor, True color | Possibility to use cob with **specific** chromatic characteristics: **RETAIL & FOOD** - Meat, fish, bread, fruit&veg | **SHOP & STYLE** - CrispWhite, CrispColor, True color



Descrizione prodotto | Product description  
p. 118



Schema di cablaggio | Connection scheme  
p. XXVIII-XXIX



Fotometrie | Photometries  
p. 119

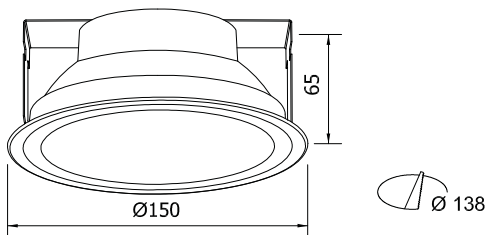

# INCA 150

## OPALE/OPAL

Ottica in policarbonato opale (Codice OP).  
Opal polycarbonate optic (Code OP).



A RICHIESTA | ON REQUEST

**5Y WARRANTY**  
5% FAILURE RATE

**60.000 h**  
LED LIFETIME L90B10

**100.000 h**  
LED LIFETIME L70B50

**>90**  
CRI

**EM**  
EN 60968-2-22

**DL**  
DALI

**PD**  
PUSH DIM

Relamping	Lumen LED*	Watt LED**	Lumen Out***	Watt	Lumen Watt Out	mA	H Altezza H Height	Codice Code	Ottica Optic	K	Alimentazione Power Supply	Colore Colour
1x13	<b>1270</b>	7,5	1085	8	> 136	180	65 mm •	<b>IC121</b>	OP: opale opal	W: 3.000  N: 4.000	— : CAE  A RICHIESTA   ON REQUEST <b>DL</b> : DALI <b>PD</b> : PUSH DIM	<b>01</b> : bianco white
1X18	<b>1740</b>	10,5	1465	11	> 133	250	65 mm •	<b>IC122</b>				
2x18	<b>2340</b>	14	1530	15,5	> 99	350	65 mm •	<b>IC123</b>				
2X26	<b>2930</b>	18,5	1910	20	> 96	450	65 mm •	<b>IC124</b>				

CE

>80  
CRI

IP44  
EN 60529

230 V  
2014/35/UE

50/60  
Hz

IK 07  
EN 60068

850°  
EN 60695

A++  
A+

RG 0  
EN 62471

01  
WHITE

02  
BLACK

05  
SILVER

IP55  
EN 60529

A richiesta | On request

TEMPERATURA AMBIENTE MIN E MAX | MIN AND MAX ROOM TEMPERATURE: (-10° +40°)

\* Lumen nominali LED max a 25° | Nominal lumen at max 25°

\*\* Potenza dei LED | LED power

\*\*\* Flusso totale in uscita dall'apparecchio a temperatura di lavoro (Ta 25° - 4.000 K) | Total lighting fitting flux output at working temperature (Ta 25° - 4.000 K) | (3.000 K -8% - CRI 90 -10%)

• H 65 mm: autodissipato | Self dissipated

#### A RICHIESTA / ON REQUEST

- Anello di compensazione, misura su richiesta | Compensation ring, dimension on request
- È possibile utilizzare COB con caratteristiche cromatiche **specifiche: RETAIL & FOOD** - Carne, pesce, pane, frutta e verdura | **SHOP & STYLE** - CrispWhite, CrispColor, True color | Possibility to use cob with **specific** chromatic characteristics: **RETAIL & FOOD** - Meat, fish, bread, fruit&veg | **SHOP & STYLE** - CrispWhite, CrispColor, True color

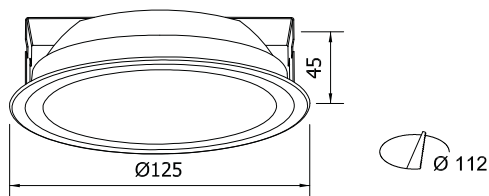

# INCA 125 OPALE/OPAL

Ottica in policarbonato opale (Codice OP).  
Opal polycarbonate optic (Code OP).



A RICHIESTA | ON REQUEST



Relamping	Lumen LED*	Watt LED**	Lumen Out***	Watt	Lumen Watt Out	mA	H Altezza H Height	Codice Code	Ottica Optic	K	Alimentazione Power Supply	Colore Colour
1x13	<b>1270</b>	7,5	1085	8	> 136	180	45 mm •	<b>IC101</b>	OP: opale opal	W: 3.000  N: 4.000	— : CAE  A RICHIESTA   ON REQUEST <b>DL</b> : DALI <b>PD</b> : PUSH DIM	<b>01</b> : bianco white
1X18	<b>1740</b>	10,5	1465	11	> 133	250	45 mm •	<b>IC102</b>				
2x18	<b>2340</b>	14	1530	15,5	> 99	350	45 mm •	<b>IC103</b>				
2X26	<b>2930</b>	18,5	1910	20	> 96	450	45 mm •	<b>IC104</b>				



A richiesta | On request

TEMPERATURA AMBIENTE MIN E MAX | MIN AND MAX ROOM TEMPERATURE: (-10° +40°)

- \* Lumen nominali LED max a 25° | Nominal lumen at max 25°
- \*\* Potenza dei LED | LED power
- \*\*\* Flusso totale in uscita dall'apparecchio a temperatura di lavoro (Ta 25° - 4.000 K) | Total lighting fitting flux output at working temperature (Ta 25° - 4.000 K) (3.000 K -8% - CRI 90 -10%)
- H 45 mm: autodissipato | Self dissipated

**A RICHIESTA / ON REQUEST**

- Anello di compensazione, misura su richiesta | Compensation ring, dimension on request
- È possibile utilizzare COB con caratteristiche cromatiche **specifiche: RETAIL & FOOD** - Carne, pesce, pane, frutta e verdura | **SHOP & STYLE** - CrispWhite, CrispColor, True color | Possibility to use cob with **specific** chromatic characteristics: **RETAIL & FOOD** - Meat, fish, bread, fruit&veg | **SHOP & STYLE** - CrispWhite, CrispColor, True color



Descrizione prodotto | Product description  
p. 118



Schema di cablaggio | Connection scheme  
p. XXVIII-XXIX



Fotometrie | Photometries  
p. 119



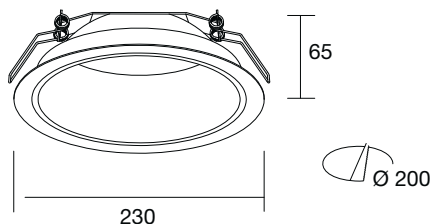

# NEW WHITE 230

## OPALE/OPAL

Ottica in policarbonato opale (Codice OP).  
Opal polycarbonate optic (Code OP).



**A RICHIESTA | ON REQUEST**

<b>5Y WARRANTY</b> 5% FAILURE RATE	<b>60.000 h</b> LED LIFETIME <b>L90B10</b>	<b>100.000 h</b> LED LIFETIME <b>L70B50</b>
---------------------------------------	---	--

<b>&gt;90</b> CRI	<b>EM</b> EN 60910-2-22	<b>DL</b> DALI	<b>PD</b> PUSH DIM
----------------------	----------------------------	-------------------	-----------------------

Relamping	Lumen LED*	Watt LED**	Lumen Out***	Watt	Lumen Watt Out	mA	H Altezza H Height	Codice Code	Ottica Optic	K	Alimentazione Power Supply	Colore Colour
2x13	<b>1740</b>	9,5	1465	11	> 131	250	65 mm	<b>NW123N01</b>	<b>OP:</b> opale opal	<b>W:</b> 3.000 <b>N:</b> 4.000	— : CAE A RICHIESTA   ON REQUEST <b>DL:</b> DALI <b>PD:</b> PUSH DIM	<b>01:</b> bianco white
1x18	<b>2340</b>	14	1975	16	> 123	350	65 mm					
2x26	<b>2930</b>	18	2470	20	> 123	450	65 mm					
2x32	<b>3220</b>	20	2560	22	> 116	500	65 mm					
2x42	<b>3840</b>	24	3275	26,5	> 124	600	65 mm					
								<b>NW12324N01</b>				

<b>CE</b>		<b>&gt;80</b> CRI	<b>IP44</b> EN 60529	<b>230 V</b> 2014/35/UE	<b>50/60</b> Hz	<b>IK 04</b> EN 60068
<b>850°</b> EN 60695	<b>A++</b> A+ A	<b>RG 0</b> EN 62471		<b>01</b> WHITE		

TEMPERATURA AMBIENTE MIN E MAX | MIN AND MAX ROOM TEMPERATURE: **(-10° +40°)**

\* Lumen nominali LED max a 25° | Nominal lumen at max 25°

\*\* Potenza dei LED | LED power

\*\*\* Flusso totale in uscita dall'apparecchio a temperatura di lavoro (Ta 25° - 4.000 K) | Total lighting fitting flux output at working temperature (Ta 25° - 4.000 K) | (3.000 K -8% - CRI 90 -10%)



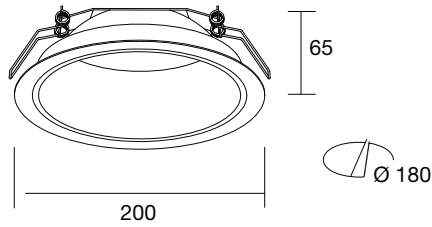

# NEW WHITE 200

## OPALE/OPAL

Ottica in policarbonato opale (Codice OP).  
Opal polycarbonate optic (Code OP).



A RICHIESTA | ON REQUEST



**5Y WARRANTY**  
5% FAILURE RATE

**60.000 h**  
LED LIFETIME L90B10

**100.000 h**  
LED LIFETIME L70B50

Relamping	Lumen LED*	Watt LED**	Lumen Out***	Watt	Lumen Watt Out	mA	H Altezza H Height	Codice Code	Ottica Optic	K	Alimentazione Power Supply	Colore Colour
2x13	<b>1740</b>	9,5	1465	11	> 131	250	65 mm	<b>NW120N01</b>	OP: opale opal	W: 3.000 N: 4.000	— : CAE A RICHIESTA   ON REQUEST DL: DALI PD: PUSH DIM	01: bianco white
1x18	<b>2340</b>	14	1975	16	> 123	350	65 mm					
2x26	<b>2930</b>	18	2470	20	> 123	450	65 mm					
2x32	<b>3220</b>	20	2560	22	> 116	500	65 mm					
2x42	<b>3840</b>	24	3275	26,5	> 124	600	65 mm					
								<b>NW12024N01</b>				



TEMPERATURA AMBIENTE MIN E MAX | MIN AND MAX ROOM TEMPERATURE: (-10° +40°)

\* Lumen nominali LED max a 25° | Nominal lumen at max 25°

\*\* Potenza dei LED | LED power

\*\*\* Flusso totale in uscita dall'apparecchio a temperatura di lavoro (Ta 25° - 4.000 K) | Total lighting fitting flux output at working temperature (Ta 25° - 4.000 K) | (3.000 K -8% - CRI 90 -10%)



Descrizione prodotto | Product description  
p. 118



Schema di cablaggio | Connection scheme  
p. XXVIII-XXIX



Fotometrie | Photometries  
p. 119

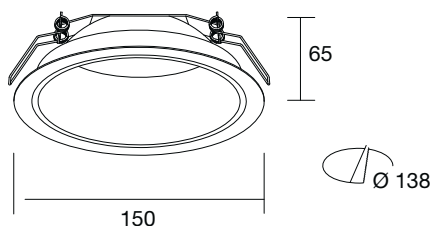

# NEW WHITE 150

## OPALE/OPAL

Ottica in policarbonato opale (Codice OP).  
Opal polycarbonate optic (Code OP).



**A RICHIESTA | ON REQUEST**

<b>5Y WARRANTY</b> 5% FAILURE RATE	<b>60.000 h</b> LED LIFETIME <b>L90B10</b>	<b>100.000 h</b> LED LIFETIME <b>L70B50</b>
---------------------------------------	---	--

<b>&gt;90</b> CRI	<b>EM</b> EN 60970-2-22	<b>DL</b> DALI	<b>PD</b> PUSH DIM
----------------------	----------------------------	-------------------	-----------------------

Relamping	Lumen LED*	Watt LED**	Lumen Out***	Watt	Lumen Watt Out	mA	H Altezza H Height	Codice Code	Ottica Optic	K	Alimentazione Power Supply	Colore Colour
2x13	<b>1740</b>	9,5	1465	11	> 131	250	65 mm	<b>NW115N01</b>	<b>OP:</b> opale opal	<b>W:</b> 3.000 <b>N:</b> 4.000	— : CAE A RICHIESTA   ON REQUEST <b>DL:</b> DALI <b>PD:</b> PUSH DIM	<b>01:</b> bianco white
1x18	<b>2340</b>	14	1975	16	> 123	350	65 mm					
2x26	<b>2930</b>	18	2470	20	> 123	450	65 mm					
2x32	<b>3220</b>	20	2560	22	> 116	500	65 mm					
2x42	<b>3840</b>	24	3275	26,5	> 124	600	65 mm					
								<b>NW11524N01</b>				

<b>CE</b>		<b>&gt;80</b> CRI	<b>IP44</b> EN 60529	<b>230 V</b> 2014/35/UE	<b>50/60</b> Hz	<b>IK 04</b> EN 60068
<b>850°</b> EN 60695	<b>A++</b> A+ A	<b>RG 0</b> EN 62471		<b>01</b> WHITE		

TEMPERATURA AMBIENTE MIN E MAX | MIN AND MAX ROOM TEMPERATURE: **(-10° +40°)**

\* Lumen nominali LED max a 25° | Nominal lumen at max 25°

\*\* Potenza dei LED | LED power

\*\*\* Flusso totale in uscita dall'apparecchio a temperatura di lavoro (Ta 25° - 4.000 K) | Total lighting fitting flux output at working temperature (Ta 25° - 4.000 K) | (3.000 K -8% - CRI 90 -10%)



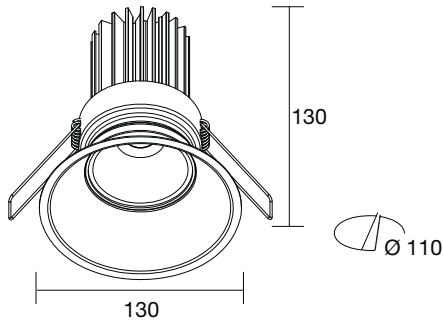

# ENNE OPALE/OPAL

Ottica in policarbonato a fascio stretto (codice ST), medio (codice MD).  
Polycarbonate optic narrow beam (code ST), medium beam (code MD)



A RICHIESTA | ON REQUEST

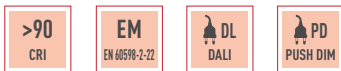

Relamping	Lumen LED*	Watt LED**	Lumen Out***	Watt	Lumen Watt Out	mA	H Altezza H Height	Codice Code	Ottica Optic	K	Alimentazione Power Supply	Colore Colour
1x35	2650	16	1960	17,5	> 107	475	130 mm •	EN01	ST: fascio stretto narrow beam	W: 3.000	— : CAE  A RICHIESTA   ON REQUEST	02: nero black
1x35	2940	18	2150	20	> 107	525	130 mm •	EN02				
1x35	3200	19,5	2340	22	> 105	575	130 mm •	EN03				
1x70	3460	21,5	2530	24	> 105	625	130 mm •	EN02	MD: fascio medio medium beam	N: 4.000	DL: DALI PD: PUSH DIM	
1x70	3700	23	2720	26	> 104	675	130 mm •	EN04				
1x70	3970	25,5	2900	28	> 104	725	130 mm •	EN05				



TEMPERATURA AMBIENTE MIN E MAX | MIN AND MAX ROOM TEMPERATURE: (-10° +40°)

\* Lumen nominali LED max a 25° | Nominal lumen at max 25°

\*\* Potenza dei LED | LED power

\*\*\* Flusso totale in uscita dall'apparecchio a temperatura di lavoro (Ta 25° - 4.000 K) | Total lighting fitting flux output at working temperature (Ta 25° - 4.000 K) | (3.000 K -8% - CRI 90 -10%)

• H 130 mm: autodissipato | Self dissipated



Descrizione prodotto | Product description  
p. 118



Schema di cablaggio | Connection scheme  
p. XXVIII-XXIX



Fotometrie | Photometries  
p. 119

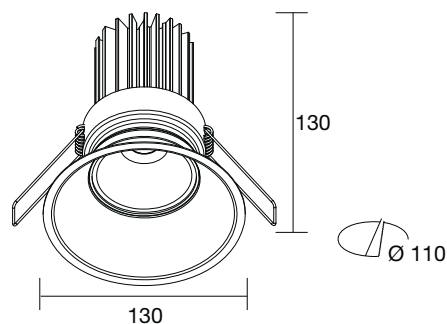

# SII

## OPALE/OPAL

Ottica in policarbonato a fascio stretto (codice ST), medio (codice MD).  
Polycarbonate optic narrow beam (code ST), medium beam (code MD)



**5Y WARRANTY**  
5% FAILURE RATE

**60.000 h**  
LED LIFETIME L90B10

**100.000 h**  
LED LIFETIME L70B50

A RICHIESTA | ON REQUEST



Relamping	Lumen LED*	Watt LED**	Lumen Out***	Watt	Lumen Watt Out	mA	H Altezza H Height	Codice Code	Ottica Optic	K	Alimentazione Power Supply	Colore Colour
1x30	2650	16	1960	17,5	> 107	475	130 mm •	<b>SI01</b>	ST: fascio stretto narrow beam	W: 3.000	— : CAE A RICHIESTA   ON REQUEST	<b>01:</b> bianco white
1x30	2940	18	2150	20	> 107	525	130 mm •	<b>SI02</b>				
1x30	3200	19,5	2340	22	> 105	575	130 mm •	<b>SI03</b>				
1x70	3460	21,5	2530	24	> 105	625	130 mm •	<b>SI02</b>	MD: fascio medio medium beam	N: 4.000	<b>DL:</b> DALI <b>PD:</b> PUSH DIM	<b>02:</b> nero black
1x70	3700	23	2720	26	> 104	675	130 mm •	<b>SI04</b>				
1x70	3970	25,5	2900	28	> 104	725	130 mm •	<b>SI05</b>				

<b>CE</b>		<b>&gt;80</b> CRI	<b>IP43</b> EN 60529	<b>230 V</b> 2014/35/UE	<b>50/60</b> Hz	<b>IK 04</b> EN 60068
<b>850°</b> EN 60695		<b>RG 0</b> EN 62471		<b>01</b> WHITE	<b>02</b> BLACK	<b>05</b> SILVER

TEMPERATURA AMBIENTE MIN E MAX | MIN AND MAX ROOM TEMPERATURE: (-10° +40°)

\* Lumen nominali LED max a 25° | Nominal lumen at max 25°

\*\* Potenza dei LED | LED power

\*\*\* Flusso totale in uscita dall'apparecchio a temperatura di lavoro (Ta 25° - 4.000 K) | Total lighting fitting flux output at working temperature (Ta 25° - 4.000 K) | (3.000 K -8% - CRI 90 -10%)

• H 130 mm: autodissipato | Self dissipated



Fotometrie | Photometries  
p. 119



Schema di cablaggio | Connection scheme  
p. XXVIII-XXIX



Descrizione prodotto | Product description  
p. 118





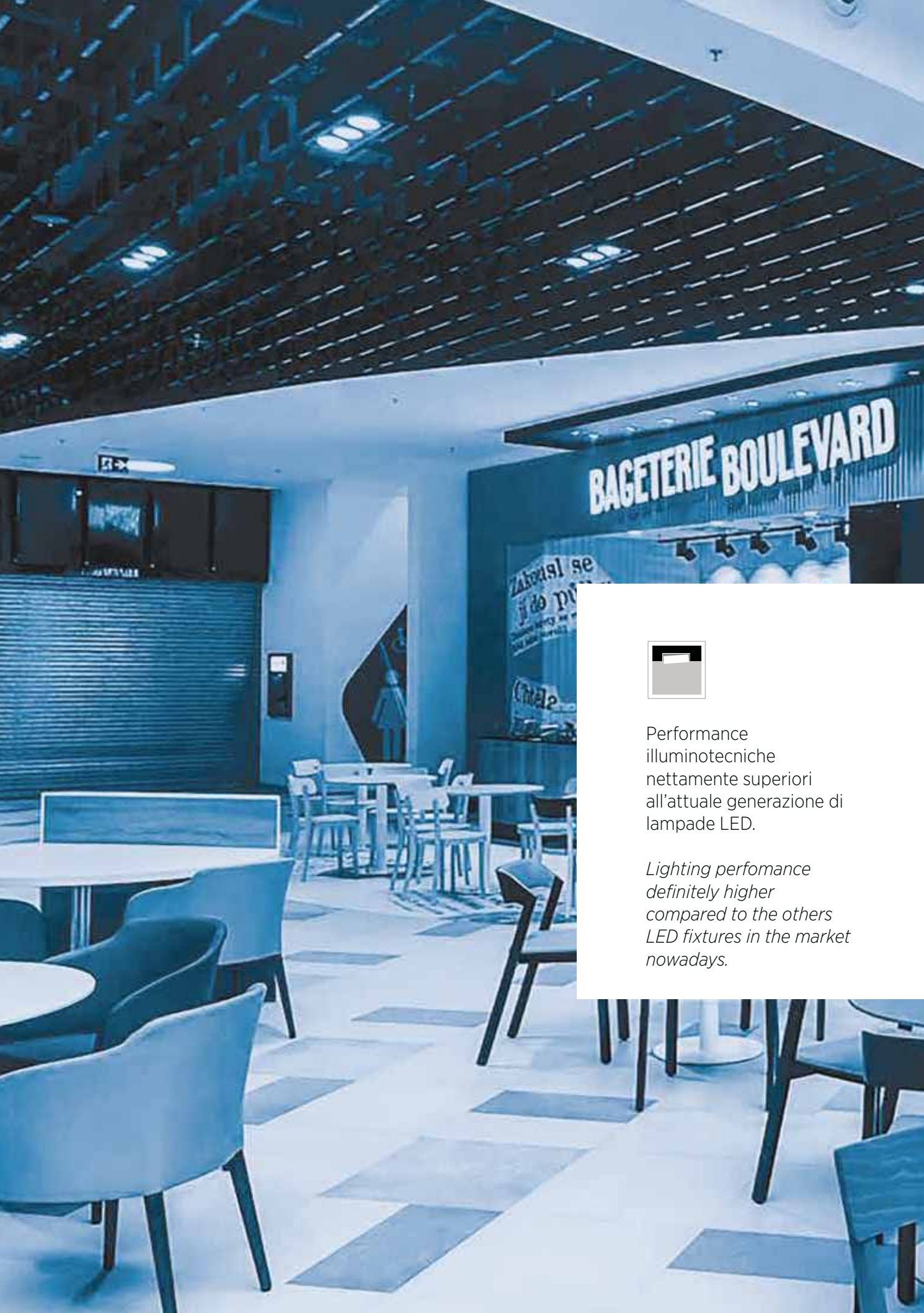

Performance illuminotecniche nettamente superiori all'attuale generazione di lampade LED.

*Lighting performance definitely higher compared to the others LED fixtures in the market nowadays.*





## INCASSO ORIENTABILI ADJUSTABLE RECESSED

Sistema di apparecchi illuminotecnici LED ad incasso orientabile per il terziario e retail.  
*LED adjustable recessed lighting fittings system for services and retail.*



# GAMMA PRODOTTI | PRODUCT RANGE

## INCASSO ORIENTABILI ADJUSTABLE RECESSED



### AUTOMA LED, 1-2-3 LUCI

p. 146-147-148

Corpo ed anello in pressofusione di alluminio verniciati con polveri epossidiche previa fosfatazione. Dissipatore in alluminio estruso ed anodizzato. Ottica in alluminio anodizzato satinato fascio largo ( cod. LA) o lucido fascio medio ( cod. MD). Sistema di fissaggio ad incasso. Non idonea per l'applicazione esterna. Sorgente luminosa LED. Emissione diretta. Alimentazione elettronica separata CAE. A richiesta: dimmerabile DALI (cod. DL) specificare se con funzione PUSH DIM (cod. PD).

*Die-cast aluminum body and ring painted with epoxy powders after phosphating. Extruded anodized aluminium heatsink. Anodized aluminium louver: satin wide beam (code LA) or polish medium beam (code MD). Recessed fixing system. Not suitable for outdoor application. LED light source. Direct light emission. Separate electronic driver CAE. On request: dimmable DALI (code DL) PUSH DIM function (code PD) to be requested.*



### GIRO LED, 1-2-3 LUCI

p. 149-150-151

Corpo ed anello in pressofusione di alluminio verniciati con polveri epossidiche previa fosfatazione. Dissipatore in alluminio estruso ed anodizzato. Ottica in alluminio anodizzato satinato fascio largo ( cod. LA) o lucido fascio medio ( cod. MD). Sistema di fissaggio ad incasso. Non idonea per l'applicazione esterna. Sorgente luminosa LED. Emissione diretta. Alimentazione elettronica separata CAE. A richiesta: dimmerabile DALI (cod. DL) specificare se con funzione PUSH DIM (cod. PD).

*Die-cast aluminum body and ring painted with epoxy powders after phosphating. Extruded anodized aluminium heatsink. Anodized aluminium louver: satin wide beam (code LA) or polish medium beam (code MD). Recessed fixing system. Not suitable for outdoor application. LED light source. Direct light emission. Separate electronic driver CAE. On request: dimmable DALI (code DL) PUSH DIM function (code PD) to be requested.*



### MINI GIRO

p. 152

Corpo ed anello in pressofusione di alluminio verniciati con polveri epossidiche previa fosfatazione. Dissipatore in alluminio estruso ed anodizzato. Ottica in alluminio anodizzato satinato fascio largo ( cod. LA) o lucido fascio medio ( cod. MD). Sistema di fissaggio ad incasso. Non idonea per l'applicazione esterna. Sorgente luminosa LED. Emissione diretta. Alimentazione elettronica separata CAE. A richiesta: dimmerabile DALI (cod. DL) specificare se con funzione PUSH DIM (cod. PD).

*Die-cast aluminum body and ring painted with epoxy powders after phosphating. Extruded anodized aluminium heatsink. Anodized aluminium louver: satin wide beam (code LA) or polish medium beam (code MD). Recessed fixing system. Not suitable for outdoor application. LED light source. Direct light emission. Separate electronic driver CAE. On request: dimmable DALI (code DL) PUSH DIM function (code PD) to be requested.*



### ROLLER LED

p. 153

Corpo ed anello in pressofusione di alluminio verniciati con polveri epossidiche previa fosfatazione. Dissipatore in alluminio estruso ed anodizzato. Ottica in alluminio anodizzato satinato fascio largo ( cod. LA) o lucido fascio medio ( cod. MD). Sistema di fissaggio ad incasso. Non idonea per l'applicazione esterna. Sorgente luminosa LED. Emissione diretta. Alimentazione elettronica separata CAE. A richiesta: dimmerabile DALI (cod. DL) specificare se con funzione PUSH DIM (cod. PD).

*Die-cast aluminum body and ring painted with epoxy powders after phosphating. Extruded anodized aluminium heatsink. Anodized aluminium louver: satin wide beam (code LA) or polish medium beam (code MD). Recessed fixing system. Not suitable for outdoor application. LED light source. Direct light emission. Separate electronic driver CAE. On request: dimmable DALI (code DL) PUSH DIM function (code PD) to be requested.*



### MINIAUTOMA LED, 1-2-3 LUCI

p.154-155-156

Corpo ed anello in pressofusione di alluminio verniciati con polveri epossidiche previa fosfatazione. Dissipatore in alluminio. Ottica in PMMA fascio largo (cod. LA) o fascio stretto (cod. ST). Sistema di fissaggio ad incasso. Non idonea per l'applicazione esterna. Sorgente luminosa LED. Emissione diretta. Alimentazione elettronica separata CAE. A richiesta: dimmerabile taglio di fase (cod. CAE TDIM) specificare se con funzione PUSH DIM (cod. PD).

*Die-cast aluminum body and ring painted with epoxy powders after phosphating. Aluminium heatsink. PMMA louver, wide beam (code LA) or narrow beam (code ST). Recessed fixing system. Not suitable for outdoor application. LED light source. Direct light emission. Separate electronic driver CAE. On request: trailing edge dimmer (code CAE TDIM) PUSH DIM function (code PD) to be requested.*

# FOTOMETRIE | PHOTOMETRIES

**INCASSO ORIENTABILI**  
ADJUSTABLE RECESSED

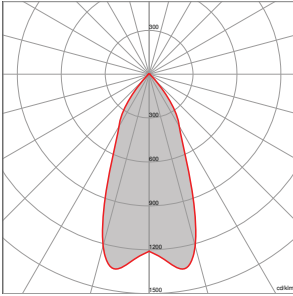

**AUTOMA LED** | Fascio/Beam | LA

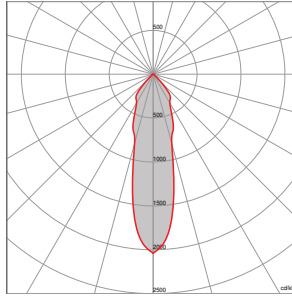

**AUTOMA LED** | Fascio/Beam | MD

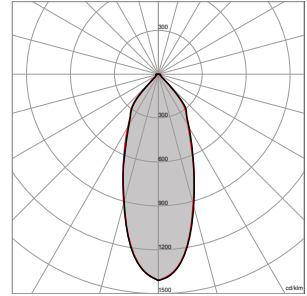

**GIRO LED** | Fascio/Beam | LA

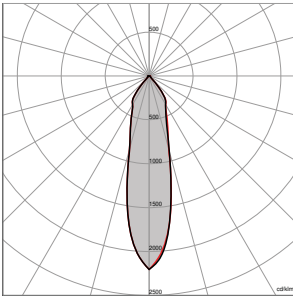

**GIRO LED** | Fascio/Beam | MD

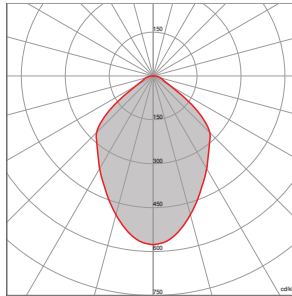

**MINI GIRO** | Fascio/Beam | LA

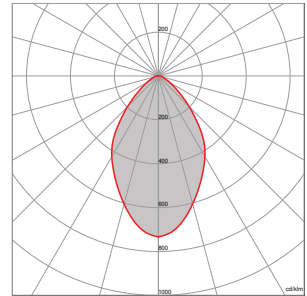

**MINI GIRO** | Fascio/Beam | MD

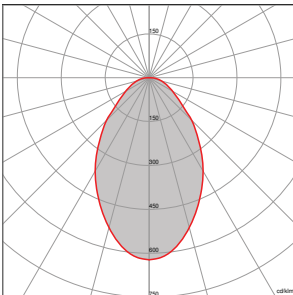

**ROLLER LED** | Fascio/Beam | LA

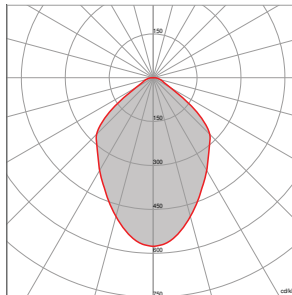

**ROLLER LED** | Fascio/Beam | MD

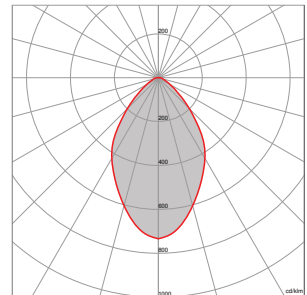

**MINIAUTOMA LED** | Fascio/Beam | LA

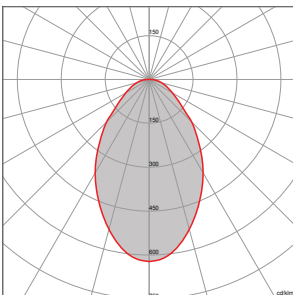

**MINIAUTOMA LED** | Fascio/Beam | ST



Rimani aggiornato  
Keep up to date

# GAMMA PRODOTTI | PRODUCT RANGE

## INCASSO ORIENTABILI ADJUSTABLE RECESSED



### RUMBA LED

p. 157

Corpo in lamiera di acciaio pressopiegata, verniciato con polveri epossidiche previa fosfatazione. Dissipatore in alluminio. Lenti in PMMA: fascio largo (cod. LA) e fascio stretto (cod. ST). Sistema di fissaggio ad incasso. Non idonea per l'applicazione esterna. Sorgente luminosa LED. Emissione diretta. Alimentazione elettronica separata CAE. A richiesta: dimmerabile taglio di fase (cod. CAE TDIM) specificare se con funzione PUSH DIM (cod. PD)

*Bent sheet steel body painted with epoxy powders after phosphating. Aluminium heatsink. PMMA louver: wide beam (code LA) or narrow beam (code ST). Recessed fixing system. Not suitable for outdoor application. LED light source. Direct light emission. Separate electronic driver CAE. On request: trailing edge dimmer (code CAE TDIM) PUSH DIM function (code PD) to be requested.*



### FLAMENKO LED

p. 158

Corpo in pressofusione d'alluminio verniciato con polveri epossidiche previa fosfatazione. Dissipatore in alluminio. Lenti in PMMA: fascio largo (cod. LA) e fascio stretto (cod. ST). Sistema di fissaggio ad incasso. Non idonea per l'applicazione esterna. Sorgente luminosa LED. Emissione diretta. Alimentazione elettronica separata CAE.

*Die-cast aluminum body painted with epoxy powders after phosphating. Aluminium heatsink. PMMA louver: wide beam (code LA) or narrow beam (code ST). Recessed fixing system. Not suitable for outdoor application. LED light source. Direct light emission. Separate electronic driver CAE.*



### JWE LED

p. 159

Corpo in lamiera di acciaio pressopiegata verniciato con polveri epossidiche previa fosfatazione. Dissipatore in alluminio. Lenti in PMMA: fascio largo (cod. LA) e fascio stretto (cod. ST). Sistema di fissaggio ad incasso. Non idonea per l'applicazione esterna. Sorgente luminosa LED. Emissione diretta. Alimentazione elettronica separata CAE.

*Bent sheet steel body painted with epoxy powders after phosphating. Aluminium heatsink. PMMA louver: wide beam (code LA) or narrow beam (code ST). Recessed fixing system. Not suitable for outdoor application. LED light source. Direct light emission. Separate electronic driver CAE.*



### MAMBO LED

p. 160

Corpo in pressofusione di alluminio verniciato con polveri epossidiche previa fosfatazione. Dissipatore in alluminio. Lenti in PMMA: fascio largo (cod. LA) e fascio stretto (cod. ST). Sistema di fissaggio ad incasso. Non idonea per l'applicazione esterna. Sorgente luminosa LED. Emissione diretta. Alimentazione elettronica separata CAE.

*Die-cast aluminum body painted with epoxy powders after phosphating. Aluminium heatsink. PMMA louver: wide beam (code LA) or narrow beam (code ST). Recessed fixing system. Not suitable for outdoor application. LED light source. Direct light emission. Separate electronic driver CAE.*



# FOTOMETRIE | PHOTOMETRIES

**INCASSO ORIENTABILI**  
**ADJUSTABLE RECESSED**

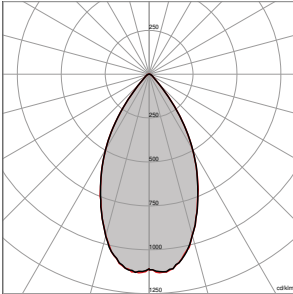

**RUMBA LED** | Fascio/Beam | LA

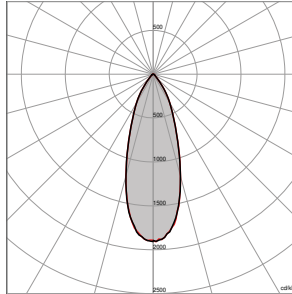

**RUMBA LED** | Fascio/Beam | ST

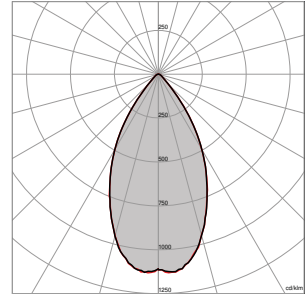

**FLAMENKO LED** | Fascio/Beam | LA

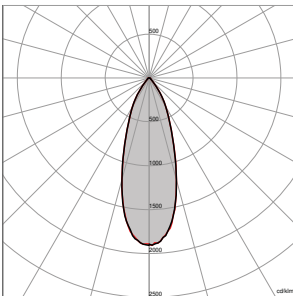

**FLAMENKO LED** | Fascio/Beam | ST

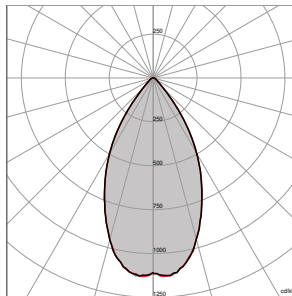

**JWE LED** | Fascio/Beam | LA

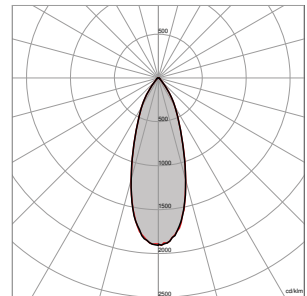

**JWE LED** | Fascio/Beam | ST

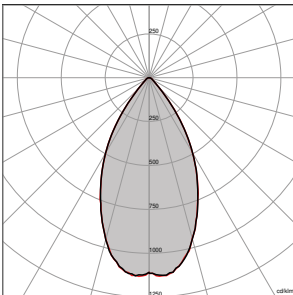

**MAMBO LED** | Fascio/Beam | LA

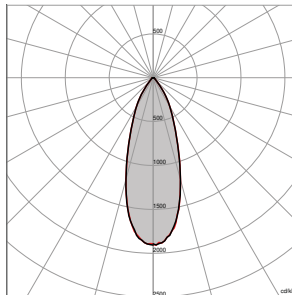

**MAMBO LED** | Fascio/Beam | ST



Rimani aggiornato  
 Keep up to date

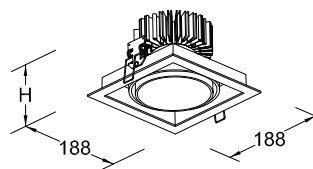
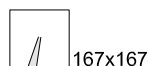

# AUTOMA LED

Apparecchio incasso a LED quadrato orientabile +/- 25°.  
Square recessed LED lighting fitting adjustable +/- 25°.



**5Y WARRANTY**  
5% FAILURE RATE

**60.000 h**  
LED LIFETIME L90B10

**100.000 h**  
LED LIFETIME L70B50

**>90**  
CRI

**EM**  
EN 60970-2-22

**DL**  
DALI

**PD**  
PUSH DIM

**A RICHIESTA | ON REQUEST**

Relamping	Lumen LED*	Watt LED**	Lumen Out***	Watt	Lumen Watt Out	mA	H Altezza H Height	Codice Code	Fascio Beam	K	Alimentazione Power Supply	Colore Colour
1X18	<b>2100</b>	11,5	1700	12	> 142	350	80 mm •	<b>AAL17</b>	<b>LA:</b> fascio largo wide beam  <b>MD:</b> fascio medio medium beam	<b>W:</b> 3.000  <b>N:</b> 4.000	<b>—</b> : CAE  A RICHIESTA   ON REQUEST <b>DL</b> : DALI <b>PD</b> : PUSH DIM	<b>01:</b> bianco white  <b>02:</b> nero black  <b>05:</b> grigio silver
2X18	<b>2700</b>	15	2250	16	> 141	450	80 mm •	<b>AAL19</b>				
2X18	<b>3300</b>	19	2750	20	> 138	550	120 mm •	<b>AAL23</b>				
2X32	<b>3800</b>	22,5	3165	23,5	> 135	650	120 mm •	<b>AAL28</b>				
2X42	<b>4100</b>	25	3515	26,5	> 133	700	120 mm •	<b>AAL33</b>				
1X70	<b>5380</b>	31	4430	32,5	> 136	900	170 mm •	<b>AAL43</b>				
1X100	<b>6200</b>	37	5050	38,5	> 131	1050	170 mm •	<b>AAL51</b>				

<b>CE</b>		<b>&gt;80</b> CRI	<b>IP20</b> EN 60529	<b>230 V</b> 2014/35/UE	<b>50/60</b> Hz	<b>IK 04</b> EN 60068
<b>850°</b> EN 60695		<b>RG 0</b> EN 62471		<b>01</b> WHITE	<b>05</b> SILVER	

TEMPERATURA AMBIENTE MIN E MAX | MIN AND MAX ROOM TEMPERATURE: **(-10° +40°)**

\* Lumen nominali LED max a 25° | Nominal lumen at max 25°

\*\* Potenza dei LED | LED power

\*\*\* Flusso totale in uscita dall'apparecchio a temperatura di lavoro (Ta 25° - 4.000 K) | Total lighting fitting flux output at working temperature (Ta 25° - 4.000 K) | (3.000 K -8% - CRI 90 -10%)

- H 80 mm: autodissipato | Self dissipated
- H 120 mm - H 170 mm: con dissipatore in alluminio | with aluminium heat sink

#### A RICHIESTA / ON REQUEST

- Flangia di compensazione, misura su richiesta. | Compensation flange, dimension on request.
- È possibile utilizzare COB con caratteristiche cromatiche **specifiche**:  
**RETAIL & FOOD** - Carne, pesce, pane, frutta e verdura | **SHOP & STYLE** - CrispWhite, CrispColor, True color | Possibility to use cob with **specific** chromatic characteristics:  
**RETAIL & FOOD** - Meat, fish, bread, fruit&veg | **SHOP & STYLE** - CrispWhite, CrispColor, True color



Fotometrie | Photometries  
p. 143



Schema di cablaggio | Connection scheme  
p. XXVIII-XXIX



Descrizione prodotto | Product description  
p. 142

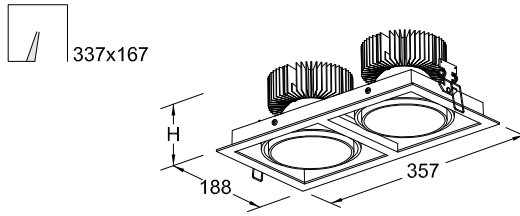

# AUTOMA LED

Apparecchio incasso a LED quadrato orientabile +/- 25°.  
Square recessed LED lighting fitting adjustable +/- 25°.



A RICHIESTA | ON REQUEST

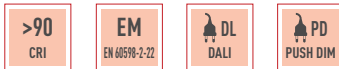

**5Y WARRANTY**  
5% FAILURE RATE

**60.000 h**  
LED LIFETIME L90B10

**100.000 h**  
LED LIFETIME L70B50

Relamping	Lumen LED*	Watt LED**	Lumen Out***	Watt	Lumen Watt Out	mA	H Altezza H Height	Codice Code	Fascio Beam	K	Alimentazione Power Supply	Colore Colour
1+1X18	<b>4200</b>	2x11,5	3400	2x12	> 142	350	80 mm •	<b>AAL217</b>	<b>LA:</b> fascio largo wide beam  <b>MD:</b> fascio medio medium beam	<b>W:</b> 3.000  <b>N:</b> 4.000	<b>—</b> : CAE  A RICHIESTA   ON REQUEST <b>DL:</b> DALI <b>PD:</b> PUSH DIM	<b>01:</b> bianco white  <b>02:</b> nero black  <b>05:</b> grigio silver
2+2X18	<b>5400</b>	2x15	4500	2x16	> 141	450	80 mm •	<b>AAL219</b>				
2+2X18	<b>6600</b>	2x19	5500	2x20	> 138	550	120 mm •	<b>AAL223</b>				
2+2X32	<b>7600</b>	2x22,5	6330	2x23,5	> 135	650	120 mm •	<b>AAL228</b>				
2+2X42	<b>8200</b>	2x25	7030	2x26,5	> 133	700	120 mm •	<b>AAL233</b>				
1+1X70	<b>10760</b>	2x31	8860	2x32,5	> 136	900	170 mm •	<b>AAL243</b>				
1+1X100	<b>12400</b>	2x37	10100	2x38,5	> 131	1050	170 mm •	<b>AAL251</b>				



A richiesta | On request

TEMPERATURA AMBIENTE MIN E MAX | MIN AND MAX ROOM TEMPERATURE: (-10° +40°)

\* Lumen nominali LED max a 25° | Nominal lumen at max 25°

\*\* Potenza dei LED | LED power

\*\*\* Flusso totale in uscita dall'apparecchio a temperatura di lavoro (Ta 25° - 4.000 K) | Total lighting fitting flux output at working temperature (Ta 25° - 4.000 K) | (3.000 K -8% - CRI 90 -10%)

- H 80 mm: autodissipato | Self dissipated
- H 120 mm - H 170 mm: con dissipatore in alluminio | with aluminium heat sink

#### A RICHIESTA / ON REQUEST

- Flangia di compensazione, misura su richiesta. | Compensation flange, dimension on request.
- È possibile utilizzare COB con caratteristiche cromatiche **specifiche**:  
**RETAIL & FOOD** - Carne, pesce, pane, frutta e verdura | **SHOP & STYLE** - CrispWhite, CrispColor, True color | Possibility to use cob with **specific** chromatic characteristics:  
**RETAIL & FOOD** - Meat, fish, bread, fruit&veg | **SHOP & STYLE** - CrispWhite, CrispColor, True color

Descrizione prodotto | Product description  
p. 142

Schema di cablaggio | Connection scheme  
p. XXVIII-XXIX

Fotometrie | Photometries  
p. 143



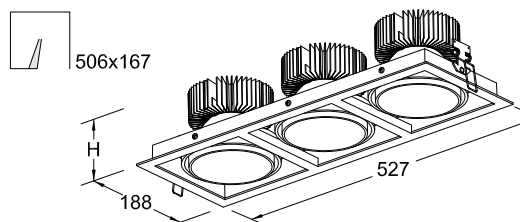

# AUTOMA LED

Apparecchio incasso a LED quadrato orientabile +/- 25°.  
Square recessed LED lighting fitting adjustable +/- 25°.



**5Y WARRANTY**  
5% FAILURE RATE

**60.000 h**  
LED LIFETIME L90B10

**100.000 h**  
LED LIFETIME L70B50

A RICHIESTA | ON REQUEST

>90  
CRI

EM  
EN 60970-2-22

DL  
DALI

PD  
PUSH DIM

Relamping	Lumen LED*	Watt LED**	Lumen Out***	Watt	Lumen Watt Out	mA	H Altezza H Height	Code Code	Fascio Beam	K	Alimentazione Power Supply	Colore Colour
1+1+1X18	<b>6300</b>	3x11,5	5100	3x12	> 142	350	80 mm •	<b>AAL317</b>	LA: fascio largo wide beam MD: fascio medio medium beam	W: 3.000 N: 4.000	— : CAE A RICHIESTA   ON REQUEST DL: DALI PD: PUSH DIM	01: bianco white 02: nero black 05: grigio silver
2+2+2X18	<b>8100</b>	3x15	6750	3x16	> 141	450	80 mm •	<b>AAL319</b>				
2+2+2X18	<b>9900</b>	3x19	8250	3x20	> 138	550	120 mm •	<b>AAL323</b>				
2+2+2X32	<b>11400</b>	3x22,5	9495	3x23,5	> 135	650	120 mm •	<b>AAL328</b>				
2+2+2X42	<b>12300</b>	3x25	10545	3x26,5	> 133	700	120 mm •	<b>AAL333</b>				
1+1+1X70	<b>14140</b>	3x31	13290	3x32,5	> 136	900	170 mm •	<b>AAL343</b>				
1+1+1X100	<b>18600</b>	3x37	15150	3x38,5	> 131	1050	170 mm •	<b>AAL351</b>				

CE	◻	>80 CRI	IP20 EN 60529	230 V 2014/35/UE	50/60 Hz	IK 04 EN 60068
850° EN 60695	A++ A	RG 0 EN 62471	◻	01 WHITE	02 BLACK	05 SILVER

TEMPERATURA AMBIENTE MIN E MAX | MIN AND MAX ROOM TEMPERATURE: (-10° +40°)

\* Lumen nominali LED max a 25° | Nominal lumen at max 25°

\*\* Potenza dei LED | LED power

\*\*\* Flusso totale in uscita dall'apparecchio a temperatura di lavoro (Ta 25° - 4.000 K) | Total lighting fitting flux output at working temperature (Ta 25° - 4.000 K) | (3.000 K -8% - CRI 90 -10%)

- H 80 mm: autodissipato | Self dissipated
- H 120 mm - H 170 mm: con dissipatore in alluminio | with aluminium heat sink

#### A RICHIESTA / ON REQUEST

- Flangia di compensazione, misura su richiesta. | Compensation flange, dimension on request.
- È possibile utilizzare COB con caratteristiche cromatiche **specifiche**:  
**RETAIL & FOOD** - Carne, pesce, pane, frutta e verdura | **SHOP & STYLE** - CrispWhite, CrispColor, True color | Possibility to use cob with **specific** chromatic characteristics:  
**RETAIL & FOOD** - Meat, fish, bread, fruit&veg | **SHOP & STYLE** - CrispWhite, CrispColor, True color



Fotometrie | Photometries  
p. 143



Schema di cablaggio | Connection scheme  
p. XXVIII-XXIX



Descrizione prodotto | Product description  
p. 142

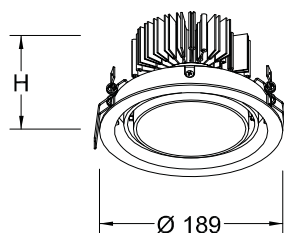

## GIRO LED

Apparecchio incasso a LED tondo orientabile +/- 25°.  
Round recessed LED lighting fitting adjustable +/- 25°.



A RICHIESTA | ON REQUEST



**5Y WARRANTY**  
5% FAILURE RATE

**60.000 h**  
LED LIFETIME L90B10

**100.000 h**  
LED LIFETIME L70B50

Relamping	Lumen LED*	Watt LED**	Lumen Out***	Watt	Lumen Watt Out	mA	H Altezza H Height	Codice Code	Fascio Beam	K	Alimentazione Power Supply	Colore Colour
1X18	<b>2100</b>	11,5	1700	12	> 142	350	80 mm •	<b>GRL17</b>	<b>LA:</b> fascio largo wide beam  <b>MD:</b> fascio medio medium beam	<b>W:</b> 3.000  <b>N:</b> 4.000	<b>—</b> : CAE  A RICHIESTA   ON REQUEST <b>DL:</b> DALI <b>PD:</b> PUSH DIM	<b>01:</b> bianco white  <b>02:</b> nero black  <b>05:</b> grigio silver
2X18	<b>2700</b>	15	2240	16	> 140	450	80 mm •	<b>GRL19</b>				
2X18	<b>3300</b>	19	2740	20	> 137	550	120 mm •	<b>GRL23</b>				
2X32	<b>3800</b>	22,5	3155	23,5	> 134	650	120 mm •	<b>GRL28</b>				
2X42	<b>4100</b>	25	3410	26,5	> 129	700	120 mm •	<b>GRL33</b>				
1X70	<b>5380</b>	31	4470	32,5	> 138	900	170 mm •	<b>GRL43</b>				
1X100	<b>6200</b>	37	5100	38,5	> 132	1050	170 mm •	<b>GRL51</b>				



TEMPERATURA AMBIENTE MIN E MAX | MIN AND MAX ROOM TEMPERATURE: (-10° +40°)

\* Lumen nominali LED max a 25° | Nominal lumen at max 25°

\*\* Potenza dei LED | LED power

\*\*\* Flusso totale in uscita dall'apparecchio a temperatura di lavoro (Ta 25° - 4.000 K) | Total lighting fitting flux output at working temperature (Ta 25° - 4.000 K) | (3.000 K -8% - CRI 90 -10%)

- H 80 mm: autodissipato | Self dissipated
- H 120 mm - H 170 mm: con dissipatore in alluminio | with aluminium heat sink

#### A RICHIESTA / ON REQUEST

- Anello di compensazione, misura su richiesta. | Compensation ring, dimension on request.
- È possibile utilizzare COB con caratteristiche cromatiche **specifiche**:  
**RETAIL & FOOD** - Carne, pesce, pane, frutta e verdura | **SHOP & STYLE** - CrispWhite, CrispColor, True color | Possibility to use cob with **specific** chromatic characteristics:  
**RETAIL & FOOD** - Meat, fish, bread, fruit&veg | **SHOP & STYLE** - CrispWhite, CrispColor, True color



Descrizione prodotto | Product description  
p. 142



Schema di cablaggio | Connection scheme  
p. XXVIII-XXIX



Fotometrie | Photometries  
p. 143

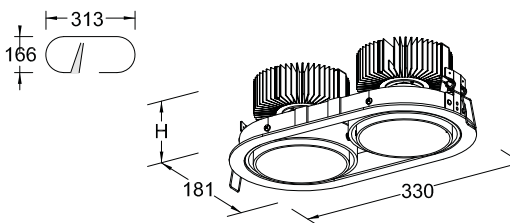

# GIRO LED

Apparecchio incasso a LED tondo orientabile +/- 25°.  
Round recessed LED lighting fitting adjustable +/- 25°.



**5Y WARRANTY**  
5% FAILURE RATE

**60.000 h**  
LED LIFETIME L90B10

**100.000 h**  
LED LIFETIME L70B50

**>90**  
CRI

**EM**  
EN 60970-2-22

**DL**  
DALI

**PD**  
PUSH DIM

A RICHIESTA | ON REQUEST

Relamping	Lumen LED*	Watt LED**	Lumen Out***	Watt	Lumen Watt Out	mA	H Altezza H Height	Codice Code	Fascio Beam	K	Alimentazione Power Supply	Colore Colour
1+1X18	<b>4200</b>	2x11,5	3400	2x12	> 142	350	80 mm •	<b>GRL217</b>				
2+2X18	<b>5400</b>	2x15	4480	2x16	> 140	450	80 mm •	<b>GRL219</b>				
2+2X18	<b>6600</b>	2x19	5480	2x20	> 137	550	120 mm •	<b>GRL223</b>	LA: fascio largo wide beam	W: 3.000	— : CAE	<b>01:</b> bianco white
2+2X32	<b>7600</b>	2x22,5	6310	2x13,5	> 134	650	120 mm •	<b>GRL228</b>	MD: fascio medio medium beam	N: 4.000	A RICHIESTA   ON REQUEST DL: DALI PD: PUSH DIM	<b>02:</b> nero black
2+2X42	<b>8200</b>	2x25	6820	2x26,5	> 129	700	120 mm •	<b>GRL233</b>				<b>05:</b> grigio silver
1+1X70	<b>10760</b>	2x31	8940	2x32,5	> 138	900	170 mm •	<b>GRL243</b>				
1+1X100	<b>12400</b>	2x37	10200	2x38,5	> 132	1050	170 mm •	<b>GRL251</b>				

<b>CE</b>		<b>&gt;80</b> CRI	<b>IP20</b> EN 60529	<b>230 V</b> 2014/35/UE	<b>50/60</b> Hz	<b>IK 04</b> EN 60068
<b>850°</b> EN 60695		<b>RG 0</b> EN 62471		<b>01</b> WHITE	<b>02</b> BLACK	<b>05</b> SILVER

TEMPERATURA AMBIENTE MIN E MAX | MIN AND MAX ROOM TEMPERATURE: (-10° +40°)

\* Lumen nominali LED max a 25° | Nominal lumen at max 25°

\*\* Potenza dei LED | LED power

\*\*\* Flusso totale in uscita dall'apparecchio a temperatura di lavoro (Ta 25° - 4.000 K) | Total lighting fitting flux output at working temperature (Ta 25° - 4.000 K) | (3.000 K -8% - CRI 90 -10%)

- H 80 mm: autodissipato | Self dissipated
- H 120 mm - H 170 mm: con dissipatore in alluminio | with aluminium heat sink

#### A RICHIESTA / ON REQUEST

- Anello di compensazione, misura su richiesta. | Compensation ring, dimension on request.
- È possibile utilizzare COB con caratteristiche cromatiche **specifiche**:  
**RETAIL & FOOD** - Carne, pesce, pane, frutta e verdura | **SHOP & STYLE** - CrispWhite, CrispColor, True color | Possibility to use cob with **specific** chromatic characteristics:  
**RETAIL & FOOD** - Meat, fish, bread, fruit&veg | **SHOP & STYLE** - CrispWhite, CrispColor, True color



Fotometrie | Photometries  
p. 143



Schema di cablaggio | Connection scheme  
p. XXVIII-XXIX



Descrizione prodotto | Product description  
p. 142

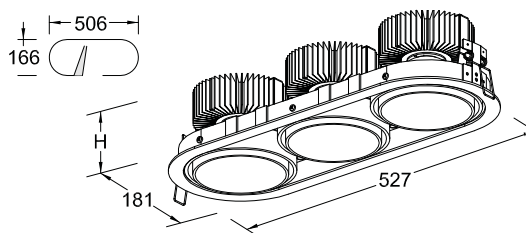

# GIRO LED

Apparecchio incasso a LED tondo orientabile +/- 25°. Round recessed LED lighting fitting adjustable +/- 25°.



A RICHIESTA | ON REQUEST

>90  
CRI

EM  
EN 60598-2-22

DL  
DALI

PD  
PUSH DIM

**5Y WARRANTY**  
5% FAILURE RATE

**60.000 h**  
LED LIFETIME L90B10

**100.000 h**  
LED LIFETIME L70B50

Relamping	Lumen LED*	Watt LED**	Lumen Out***	Watt	Lumen Watt Out	mA	H Altezza H Height	Codice Code	Fascio Beam	K	Alimentazione Power Supply	Colore Colour
1+1+1X18	<b>6300</b>	3x11,5	5100	3x12	> 142	350	80 mm •	<b>GRL317</b>				
2+2+2X18	<b>8100</b>	3x15	6720	3x16	> 140	450	80 mm •	<b>GRL319</b>				
2+2+2X18	<b>9900</b>	3x19	8220	3x20	> 137	550	120 mm •	<b>GRL323</b>	LA: fascio largo wide beam MD: fascio medio medium beam	W: 3.000 N: 4.000	— : CAE A RICHIESTA   ON REQUEST DL: DALI PD: PUSH DIM	01: bianco white 02: nero black 05: grigio silver
2+2+2X32	<b>11400</b>	3x22,5	9465	3x13,5	> 134	650	120 mm •	<b>GRL328</b>				
2+2+2X42	<b>12300</b>	3x25	10230	3x26,5	> 129	700	120 mm •	<b>GRL333</b>				
1+1+1X70	<b>14140</b>	3x31	13410	3x32,5	> 138	900	170 mm •	<b>GRL343</b>				
1+1+1X100	<b>18600</b>	3x37	15300	3x38,5	> 132	1050	170 mm •	<b>GRL351</b>				

CE

>80  
CRI

IP20  
EN 60529

230 V  
2014/35/UE

50/60  
Hz

IK 04  
EN 60068

850°  
EN 60695

A++  
A

RG 0  
EN 62471

01  
WHITE

02  
BLACK

05  
SILVER

TEMPERATURA AMBIENTE MIN E MAX | MIN AND MAX ROOM TEMPERATURE: (-10° +40°)

\* Lumen nominali LED max a 25° | Nominal lumen at max 25°

\*\* Potenza dei LED | LED power

\*\*\* Flusso totale in uscita dall'apparecchio a temperatura di lavoro (Ta 25° - 4.000 K) | Total lighting fitting flux output at working temperature (Ta 25° - 4.000 K) | (3.000 K -8% - CRI 90 -10%)

- H 80 mm: autodissipato | Self dissipated
- H 120 mm - H 170 mm: con dissipatore in alluminio | with aluminium heat sink

**A RICHIESTA / ON REQUEST**

- Anello di compensazione, misura su richiesta. | Compensation ring, dimension on request.
- È possibile utilizzare COB con caratteristiche cromatiche **specifiche**:  
**RETAIL & FOOD** - Carne, pesce, pane, frutta e verdura | **SHOP & STYLE** - CrispWhite, CrispColor, True color | Possibility to use cob with **specific** chromatic characteristics:  
**RETAIL & FOOD** - Meat, fish, bread, fruit&veg | **SHOP & STYLE** - CrispWhite, CrispColor, True color

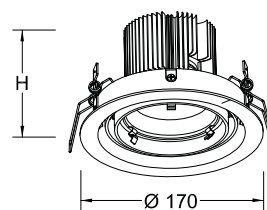

# MINI GIRO

Faretto LED ad incasso tondo per interni orientabile.  
Adjustable round recessed LED spotlight for indoor.



**5Y WARRANTY**  
5% FAILURE RATE

**60.000 h**  
LED LIFETIME L90B10

**100.000 h**  
LED LIFETIME L70B50

**>90**  
CRI

**EM**  
EN 60968-2-22

**DL**  
DALI

**PD**  
PUSH DIM

A RICHIESTA | ON REQUEST

Relamping	Lumen LED*	Watt LED**	Lumen Out***	Watt	Lumen Watt Out	mA	H Altezza H Height	Codice Code	Fascio Beam	K	Alimentazione Power Supply	Colore Colour
1X18	<b>2100</b>	11,5	1795	12	> 150	350	60 mm •	<b>MGRL17</b>				
2X18	<b>2700</b>	15	2313	16	> 145	450	60 mm •	<b>MGRL19</b>	LA: fascio largo wide beam	W: 3.000	— : CAE	A RICHIESTA   ON REQUEST <b>DL</b> : DALI <b>PD</b> : PUSH DIM
2X18	<b>3300</b>	19	2825	20	> 141	550	100 mm •	<b>MGRL20</b>				
2X32	<b>3800</b>	22,5	3255	23,5	> 139	650	100 mm •	<b>MGRL24</b>				
2X42	<b>4100</b>	25	3510	26,5	> 132	700	100 mm •	<b>MGRL28</b>				

<b>CE</b>		<b>&gt;80</b> CRI	<b>IP20</b> EN 60529	<b>230 V</b> 2014/35/UE	<b>50/60</b> Hz	<b>IK 04</b> EN 60068
<b>850°</b> EN 60695		<b>RG 0</b> EN 62471		<b>01</b> WHITE	<b>02</b> BLACK	<b>05</b> SILVER

TEMPERATURA AMBIENTE MIN E MAX | MIN AND MAX ROOM TEMPERATURE: (-10° +40°)

\* Lumen nominali LED max a 25° | Nominal lumen at max 25°

\*\* Potenza dei LED | LED power

\*\*\* Flusso totale in uscita dall'apparecchio a temperatura di lavoro (Ta 25° - 4.000 K) | Total lighting fitting flux output at working temperature (Ta 25° - 4.000 K) | (3.000 K -8% - CRI 90 -10%)

- H 60 mm: autodissipato | Self dissipated
- H 100 mm: con dissipatore in alluminio | with aluminium heat sink

#### A RICHIESTA / ON REQUEST

- Anello di compensazione, misura su richiesta. | Compensation ring, dimension on request.
- È possibile utilizzare COB con caratteristiche cromatiche **specifiche**:  
**RETAIL & FOOD** - Carne, pesce, pane, frutta e verdura | **SHOP & STYLE** - CrispWhite, CrispColor, True color | Possibility to use cob with **specific** chromatic characteristics:  
**RETAIL & FOOD** - Meat, fish, bread, fruit&veg | **SHOP & STYLE** - CrispWhite, CrispColor, True color.
- Versione 2-3 luci. | 2-3 lights version.



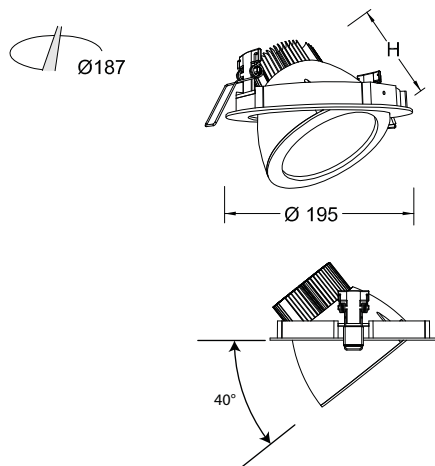

# ROLLER LED

Apparecchio incasso a LED estraibile e orientabile di 350° sull'asse orizzontale, 45° sull'asse verticale.  
 Recessed pull-out LED lighting fitting adjustable of 350° on the horizontal axis and of 45° on the vertical axis.



A RICHIESTA | ON REQUEST

>90 CRI
EM EN 60598-2-22
DL DALI
PD PUSH DIM

5Y WARRANTY 5% FAILURE RATE
60.000 h LED LIFETIME L90B10
100.000 h LED LIFETIME L70B50

Relamping	Lumen LED*	Watt LED**	Lumen Out***	Watt	Lumen Watt Out	mA	H Altezza H Height	Codice Code	Fascio Beam	K	Alimentazione Power Supply	Colore Colour
1X18	2100	11,5	1310	12	> 109	350	95 mm •	RL17				
2X18	2700	15	1690	16	> 106	450	95 mm •	RL19	LA: fascio largo wide beam MD: fascio medio medium beam	W: 3.000 N: 4.000	— : CAE A RICHIESTA   ON REQUEST DL: DALI PD: PUSH DIM	01: bianco white 05: grigio silver
2X18	3300	19	2100	20	> 105	550	125 mm •	RL23				
2X32	3800	22,5	2425	23,5	> 103	650	125 mm •	RL28				
2X42	4100	25	2560	26,5	> 97	700	125 mm •	RL33				

CE
850° EN 60695
>80 CRI
IP40 EN 60529
230 V 2014/35/UE
50/60 Hz
IK 04 EN 60068
RG0 EN 62471
01 WHITE
02 BLACK
05 SILVER

TEMPERATURA AMBIENTE MIN E MAX | MIN AND MAX ROOM TEMPERATURE: (-10° +40°)

\* Lumen nominali LED max a 25° | Nominal lumen at max 25°  
 \*\* Potenza dei LED | LED power  
 \*\*\* Flusso totale in uscita dall'apparecchio a temperatura di lavoro (Ta 25° - 4.000 K) | Total lighting fitting flux output at working temperature (Ta 25° - 4.000 K) | (3.000 K -8% - CRI 90 -10%)

- H 95 mm: autodissipato | Self dissipated
- H 125 mm: con dissipatore in alluminio | with aluminium heat sink

A RICHIESTA / ON REQUEST

- Anello di compensazione, misura su richiesta. | Compensation ring, dimension on request.
- È possibile utilizzare COB con caratteristiche cromatiche specifiche:  
**RETAIL & FOOD** - Carne, pesce, pane, frutta e verdura | **SHOP & STYLE** - CrispWhite, CrispColor, True color | Possibility to use cob with specific chromatic characteristics:  
**RETAIL & FOOD** - Meat, fish, bread, fruit&veg | **SHOP & STYLE** - CrispWhite, CrispColor, True color.
- Versione 2-3 luci. | 2-3 lights version.

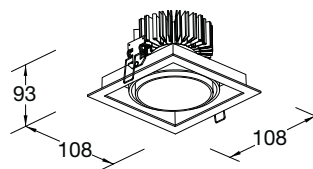

# MINIAUTOMA LED

Apparecchio ad incasso LED orientabile +/-25°  
Recessed LED lighting fitting adjustable through +/-25°



A RICHIESTA | ON REQUEST

**5Y WARRANTY**  
5% FAILURE RATE

**60.000 h**  
LED LIFETIME L90B10

**100.000 h**  
LED LIFETIME L70B50

>90  
CRI

EM  
EN 60518-2-22

Relamping	Lumen LED*	Watt LED**	Lumen Out***	Watt	Lumen Watt Out	mA	H Altezza H Height	Codice Code	K	Fascio Beam	Alimentazione Power Supply	Colore Colour
1X50 DICRO	<b>1080</b>	14	1035	15	> 69	350	93 mm	<b>MA1L15</b>	<b>W:</b> 3.000	<b>LA:</b> fascio largo wide beam	— : CAE CAE TDIM dimmerabile taglio di fase trailing edge dimmer	<b>01:</b> bianco white
1X50 DICRO	<b>1150</b>	14	1105	15	> 74	350	93 mm	<b>MA1L15</b>	<b>N:</b> 4.000	<b>ST:</b> fascio stretto narrow beam		<b>05:</b> grigio silver

		>80 CRI	IP40 EN 60529	230 V 2014/35/UE	50/60 Hz	IK 04 EN 60068
850° EN 60695	A++ A+ A	RG 0 EN 62471		01 WHITE	05 SILVER	

TEMPERATURA AMBIENTE MIN E MAX | MIN AND MAX ROOM TEMPERATURE: (-10° +40°)

\* Lumen nominali LED max a 25° | Nominal lumen at max 25°

\*\* Potenza dei LED | LED power

\*\*\* Flusso totale in uscita dall'apparecchio a temperatura di lavoro (Ta 25° - 4.000 K) | Total lighting fitting flux output at working temperature (Ta 25° - 4.000 K) | (3.000 K -8% - CRI 90 -10%)

#### A RICHIESTA / ON REQUEST

- Flangia di compensazione, misura su richiesta. | Compensation flange, dimension on request.
- È possibile utilizzare COB con caratteristiche cromatiche **specifiche**:  
**RETAIL & FOOD** - Carne, pesce, pane, frutta e verdura | **SHOP & STYLE** - CrispWhite, CrispColor, True color | Possibility to use cob with **specific** chromatic characteristics:  
**RETAIL & FOOD** - Meat, fish, bread, fruit&veg | **SHOP & STYLE** - CrispWhite, CrispColor, True color.



Fotometrie | Photometries  
p. 143



Schema di cablaggio | Connection scheme  
p. XXVIII-XXIX



Descrizione prodotto | Product description  
p. 142



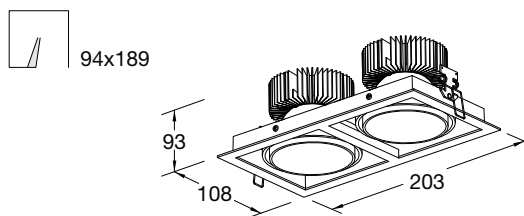

# MINIAUTOMA LED

Apparecchio ad incasso LED orientabile +/-25°  
Recessed LED lighting fitting adjustable through +/-25°



A RICHIESTA | ON REQUEST

>90  
CRI

EM  
EN 60570-2-22

5Y WARRANTY  
5% FAILURE RATE

60.000 h  
LED LIFETIME L90B10

100.000 h  
LED LIFETIME L70B50

Relamping	Lumen LED*	Watt LED**	Lumen Out***	Watt	Lumen Watt Out	mA	H Altezza H Height	Codice Code	K	Fascio Beam	Alimentazione Power Supply	Colore Colour
2X50 DICRO	2160	2x14	2070	2x15	> 69	350	93 mm	MA2L15	W: 3.000	LA: fascio largo wide beam	- : CAE  CAE TDIM dimmerabile taglio di fase trailing edge dimmer	01: bianco white
2X50 DICRO	2300	2x14	2210	2x15	> 74	350	93 mm	MA2L15	N: 4.000	ST: fascio stretto narrow beam		05: grigio silver

CE	□	>80 CRI	IP40 EN 60529	230 V 2014/35/UE	50/60 Hz	IK 04 EN 60068
850° EN 60695	A++ A+ A	RG 0 EN 62471	🏠	01 WHITE	05 SILVER	

TEMPERATURA AMBIENTE MIN E MAX | MIN AND MAX ROOM TEMPERATURE: (-10° +40°)

\* Lumen nominali LED max a 25° | Nominal lumen at max 25°

\*\* Potenza dei LED | LED power

\*\*\* Flusso totale in uscita dall'apparecchio a temperatura di lavoro (Ta 25° - 4.000 K) | Total lighting fitting flux output at working temperature (Ta 25° - 4.000 K) | (3.000 K -8% - CRI 90 -10%)

**A RICHIESTA / ON REQUEST**

- Flangia di compensazione, misura su richiesta. | Compensation flange, dimension on request.
- È possibile utilizzare COB con caratteristiche cromatiche **specifiche**:  
**RETAIL & FOOD** - Carne, pesce, pane, frutta e verdura | **SHOP & STYLE** - CrispWhite, CrispColor, True color | Possibility to use cob with **specific** chromatic characteristics:  
**RETAIL & FOOD** - Meat, fish, bread, fruit&veg | **SHOP & STYLE** - CrispWhite, CrispColor, True color.



Descrizione prodotto | Product description  
p. 142



Schema di cablaggio | Connection scheme  
p. XXVIII-XXIX



Fotometrie | Photometries  
p. 143

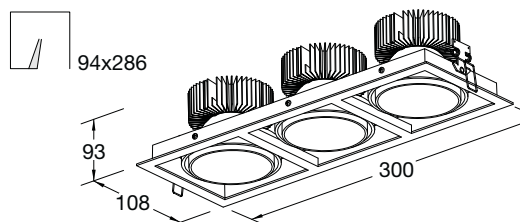

# MINIAUTOMA LED

Apparecchio ad incasso LED orientabile +/-25°  
Recessed LED lighting fitting adjustable through +/-25°



A RICHIESTA | ON REQUEST

**5Y WARRANTY**  
5% FAILURE RATE

**60.000 h**  
LED LIFETIME L90B10

**100.000 h**  
LED LIFETIME L70B50

**>90**  
CRI

**EM**  
EN 60598-2-22

Relamping	Lumen LED*	Watt LED**	Lumen Out***	Watt	Lumen Watt Out	mA	H Altezza H Height	Codice Code	K	Fascio Beam	Alimentazione Power Supply	Colore Colour
3X50 DICRO	<b>3240</b>	3x14	3105	3x15	> 69	350	93 mm	<b>MA3L15</b>	<b>W:</b> 3.000	<b>LA:</b> fascio largo wide beam	— : CAE  CAE TDIM dimmerabile taglio di fase trailing edge dimmer	<b>01:</b> bianco white
3X50 DICRO	<b>3450</b>	3x14	3315	3x15	> 74	350	93 mm	<b>MA3L15</b>	<b>N:</b> 4.000	<b>ST:</b> fascio stretto narrow beam		<b>05:</b> grigio silver

		<b>&gt;80</b> CRI	<b>IP40</b> EN 60529	<b>230 V</b> 2014/35/UE	<b>50/60</b> Hz	<b>IK 04</b> EN 60068
<b>850°</b> EN 60695		<b>RG 0</b> EN 62471		<b>01</b> WHITE	<b>05</b> SILVER	

TEMPERATURA AMBIENTE MIN E MAX | MIN AND MAX ROOM TEMPERATURE: **(-10° +40°)**

\* Lumen nominali LED max a 25° | Nominal lumen at max 25°

\*\* Potenza dei LED | LED power

\*\*\* Flusso totale in uscita dall'apparecchio a temperatura di lavoro (Ta 25° - 4.000 K) | Total lighting fitting flux output at working temperature (Ta 25° - 4.000 K) | (3.000 K -8% - CRI 90 -10%)

#### A RICHIESTA / ON REQUEST

- Flangia di compensazione, misura su richiesta. | Compensation flange, dimension on request.
- È possibile utilizzare COB con caratteristiche cromatiche **specifiche**:  
**RETAIL & FOOD** - Carne, pesce, pane, frutta e verdura | **SHOP & STYLE** - CrispWhite, CrispColor, True color | Possibility to use cob with **specific** chromatic characteristics:  
**RETAIL & FOOD** - Meat, fish, bread, fruit&veg | **SHOP & STYLE** - CrispWhite, CrispColor, True color.

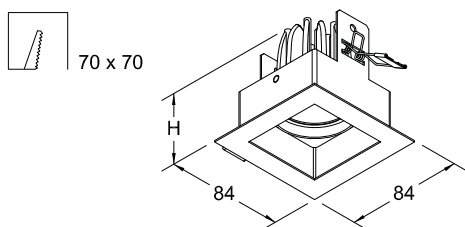

# RUMBA LED

Apparecchio ad incasso LED quadrato fisso.  
Square recessed fixed LED lighting fitting.



A RICHIESTA | ON REQUEST



**5Y WARRANTY**  
5% FAILURE RATE

**60.000 h**  
LED LIFETIME L90B10

**100.000 h**  
LED LIFETIME L70B50

Relamping	Lumen LED*	Watt LED**	Lumen Out***	Watt	Lumen Watt Out	mA	H Altezza H Height	Codice Code	K	Fascio Beam	Alimentazione Power Supply	Colore Colour
1x50 DICRO	<b>1080</b>	14	1035	15	> 69	350	<b>Max</b> 118 mm	<b>RUM15</b>	<b>W:</b> 3.000	<b>LA:</b> fascio largo wide beam	-- : CAE	<b>01:</b> bianco white
1X50 DICRO	<b>1150</b>	14	1105	15	> 74	350	<b>Max</b> 118 mm	<b>RUM15</b>	<b>N:</b> 4.000	<b>ST:</b> fascio stretto narrow beam		<b>02:</b> nero black
												<b>05:</b> grigio silver



TEMPERATURA AMBIENTE MIN E MAX | MIN AND MAX ROOM TEMPERATURE: (-10° +40°)

\* Lumen nominali LED max a 25° | Nominal lumen at max 25°

\*\* Potenza dei LED | LED power

\*\*\* Flusso totale in uscita dall'apparecchio a temperatura di lavoro (Ta 25° - 4.000 K) | Total lighting fitting flux output at working temperature (Ta 25° - 4.000 K) | (3.000 K -8% - CRI 90 -10%)

#### A RICHIESTA / ON REQUEST

- Flangia di compensazione, misura su richiesta. | Compensation flange, dimension on request.
- È possibile utilizzare COB con caratteristiche cromatiche **specifiche**:  
**RETAIL & FOOD** - Carne, pesce, pane, frutta e verdura | **SHOP & STYLE** - CrispWhite, CrispColor, True color | Possibility to use cob with **specific** chromatic characteristics:  
**RETAIL & FOOD** - Meat, fish, bread, fruit&veg | **SHOP & STYLE** - CrispWhite, CrispColor, True color.



Descrizione prodotto | Product description  
p. 144



Schema di cablaggio | Connection scheme  
p. XXVIII-XXIX



Fotometrie | Photometries  
p. 145

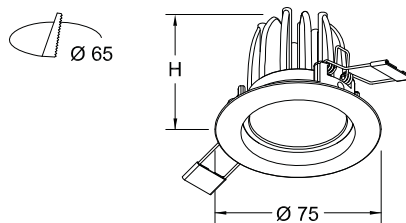

# FLAMENKO LED

Apparecchio ad incasso LED tondo fisso.  
Round recessed fixed LED lighting fitting.



**5Y WARRANTY**  
5% FAILURE RATE

**60.000 h**  
LED LIFETIME L90B10

**100.000 h**  
LED LIFETIME L70B50

A RICHIESTA | ON REQUEST



Relamping	Lumen LED*	Watt LED**	Lumen Out***	Watt	Lumen Watt Out	mA	H Altezza H Height	Codice Code	K	Fascio Beam	Alimentazione Power Supply	Colore Colour
1x50 DICRO	<b>1080</b>	14	1035	15	> 69	350	<b>Max</b> 96 mm	<b>FKL15</b>	<b>W:</b> 3.000	<b>LA:</b> fascio largo wide beam	— : CAE	<b>01:</b> bianco / white
										<b>ST:</b> fascio stretto narrow beam		<b>02:</b> nero / black
1X50 DICRO	<b>1150</b>	14	1105	15	> 74	350	<b>Max</b> 96 mm	<b>FKL15</b>	<b>N:</b> 4.000			<b>03:</b> oro / gold
												<b>04:</b> cromo lucido polished chrome
												<b>07:</b> satinato / satin



TEMPERATURA AMBIENTE MIN E MAX | MIN AND MAX ROOM TEMPERATURE: (-10° +40°)

\* Lumen nominali LED max a 25° | Nominal lumen at max 25°

\*\* Potenza dei LED | LED power

\*\*\* Flusso totale in uscita dall'apparecchio a temperatura di lavoro (Ta 25° - 4.000 K) | Total lighting fitting flux output at working temperature (Ta 25° - 4.000 K) | (3.000 K -8% - CRI 90 -10%)

#### A RICHIESTA / ON REQUEST

- Anello di compensazione, misura su richiesta. | Compensation ring, dimension on request.
- È possibile utilizzare COB con caratteristiche cromatiche **specifiche**:  
**RETAIL & FOOD** - Carne, pesce, pane, frutta e verdura | **SHOP & STYLE** - CrispWhite, CrispColor, True color | Possibility to use cob with **specific** chromatic characteristics:  
**RETAIL & FOOD** - Meat, fish, bread, fruit&veg | **SHOP & STYLE** - CrispWhite, CrispColor, True color.



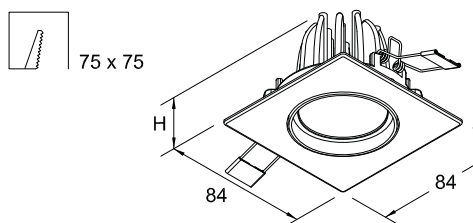

# JWE LED

Apparecchio ad incasso LED quadrato orientabile +/- 15°.  
Square recessed LED lighting fitting adjustable +/- 15°.



A RICHIESTA | ON REQUEST



Relamping	Lumen LED*	Watt LED**	Lumen Out***	Watt	Lumen Watt Out	mA	H Altezza H Height	Codice Code	K	Fascio Beam	Alimentazione Power Supply	Colore Colour
1x50 DICRO	1080	14	1035	15	> 69	350	Max 94 mm	JWE15	W: 3.000	LA: fascio largo wide beam	- : CAE	01: bianco white 02: nero black 03: oro gold 04: cromo lucido polished chrome 07: satinato satin
1X50 DICRO	1150	14	1105	15	> 74	350	Max 94 mm	JWE15	N: 4.000	ST: fascio stretto narrow beam		



TEMPERATURA AMBIENTE MIN E MAX | MIN AND MAX ROOM TEMPERATURE: (-10° +40°)

\* Lumen nominali LED max a 25° | Nominal lumen at max 25°

\*\* Potenza dei LED | LED power

\*\*\* Flusso totale in uscita dall'apparecchio a temperatura di lavoro (Ta 25° - 4.000 K) | Total lighting fitting flux output at working temperature (Ta 25° - 4.000 K) | (3.000 K -8% - CRI 90 -10%)

**A RICHIESTA / ON REQUEST**

- Flangia di compensazione, misura su richiesta. | Compensation flange, dimension on request.
- È possibile utilizzare COB con caratteristiche cromatiche **specifiche**:  
**RETAIL & FOOD** - Carne, pesce, pane, frutta e verdura | **SHOP & STYLE** - CrispWhite, CrispColor, True color | Possibility to use cob with **specific** chromatic characteristics:  
**RETAIL & FOOD** - Meat, fish, bread, fruit&veg | **SHOP & STYLE** - CrispWhite, CrispColor, True color.

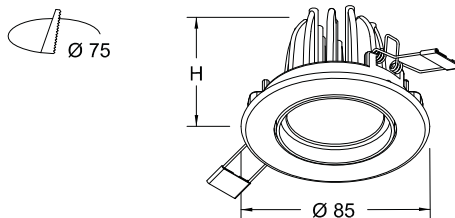

# MAMBO LED

Apparecchio ad incasso LED tondo orientabile +/- 15°.  
Round recessed LED lighting fitting adjustable +/- 15°.



**A RICHIESTA | ON REQUEST**

**5Y WARRANTY**  
5% FAILURE RATE

**60.000 h**  
LED LIFETIME L90B10

**100.000 h**  
LED LIFETIME L70B50

**>90**  
CRI

**EM**  
EN 60970-2-22

**DL**  
DALI

**PD**  
PUSH DIM

Relamping	Lumen LED*	Watt LED**	Lumen Out***	Watt	Lumen Watt Out	mA	H Altezza H Height	Codice Code	K	Fascio Beam	Alimentazione Power Supply	Colore Colour
1x50 DICRO	<b>1080</b>	14	1035	15	> 69	350	<b>Max</b> 94 mm	<b>MBL15</b>	<b>W:</b> 3.000	<b>LA:</b> fascio largo wide beam	— : CAE	<b>01:</b> bianco white
1x50 DICRO	<b>1150</b>	14	1105	15	> 74	350	<b>Max</b> 94 mm	<b>MBL15</b>	<b>N:</b> 4.000	<b>ST:</b> fascio stretto narrow beam		<b>02:</b> nero black
												<b>03:</b> oro gold
												<b>04:</b> cromo lucido polished chrome
												<b>07:</b> satinato satin

<b>CE</b>		<b>&gt;80</b> CRI	<b>IP40</b> EN 60529	<b>230 V</b> 2014/35/UE	<b>50/60</b> Hz	<b>IK 04</b> EN 60068
<b>850°</b> EN 60695	<b>A++</b> A	<b>RG 0</b> EN 62471		<b>01</b> WHITE	<b>05</b> SILVER	<b>03</b> GOLD
<b>04</b> CHROME POLISHED	<b>07</b> CHROME SATIN					

TEMPERATURA AMBIENTE MIN E MAX | MIN AND MAX ROOM TEMPERATURE: **(-10° +40°)**

\* Lumen nominali LED max a 25° | Nominal lumen at max 25°

\*\* Potenza dei LED | LED power

\*\*\* Flusso totale in uscita dall'apparecchio a temperatura di lavoro (Ta 25° - 4.000 K) | Total lighting fitting flux output at working temperature (Ta 25° - 4.000 K) | (3.000 K -8% - CRI 90 -10%)

#### A RICHIESTA / ON REQUEST

- Anello di compensazione, misura su richiesta. | Compensation ring, dimension on request.
- È possibile utilizzare COB con caratteristiche cromatiche **specifiche**:  
**RETAIL & FOOD** - Carne, pesce, pane, frutta e verdura | **SHOP & STYLE** - CrispWhite, CrispColor, True color | Possibility to use cob with **specific** chromatic characteristics:  
**RETAIL & FOOD** - Meat, fish, bread, fruit&veg | **SHOP & STYLE** - CrispWhite, CrispColor, True color.











Performance illuminotecnica nettamente superiori all'attuale generazione di lampade LED.

*Lighting performance definitely higher compared to the others LED fixtures in the market nowadays.*



## PROIETTORI A BINARIO TRACK LIGHTS

Proiettori LED per il retail.  
*LED lighting for retail.*



# GAMMA PRODOTTI | PRODUCT RANGE

## PROIETTORI A BINARIO TRACK LIGHTS



### BEBA

p. 168

Corpo in estruso d'alluminio verniciato con polveri epossidiche previa fosfatazione. Dissipatore in alluminio estruso. Ottica in policarbonato metallizzato fascio largo (cod. LA) fascio medio (cod. MD) fascio stretto (cod. ST). Sorgente luminosa LED. Emissione diretta. Sistema di fissaggio a binario (adattatore incluso). Alimentazione elettronica integrata CAE. A richiesta: dimmerabile DALI (cod. DL) specificare se con funzione PUSH DIM (cod. PD).

*Extruded aluminium body painted with epoxy powders after phosphating. Extruded aluminium heatsink. Metallized polycarbonate louver wide beam (code LA) medium beam (code MD) narrow beam (code ST). LED light source. Direct light emission. Track mounting system (adapter included). Built-in electronic driver CAE. On request: dimmable DALI (code DL) PUSH DIM function (code PD) to be requested.*



### LERICA

p. 169

Corpo in estruso d'alluminio verniciato con polveri epossidiche previa fosfatazione. Dissipatore in alluminio estruso. Ottica in policarbonato metallizzato fascio largo (cod. LA) fascio medio (cod. MD) fascio stretto (cod. ST). Sorgente luminosa LED. Emissione diretta. Sistema di fissaggio a binario (adattatore incluso). Alimentazione elettronica integrata CAE. A richiesta: dimmerabile DALI (cod. DL) specificare se con funzione PUSH DIM (cod. PD).

*Extruded aluminium body painted with epoxy powders after phosphating. Extruded aluminium heatsink. Metallized polycarbonate louver wide beam (code LA) medium beam (code MD) narrow beam (code ST). LED light source. Direct light emission. Track mounting system (adapter included). Built-in electronic driver CAE. On request: dimmable DALI (code DL) PUSH DIM function (code PD) to be requested.*



### VALE

p. 170

Corpo in estruso d'alluminio verniciato con polveri epossidiche previa fosfatazione. Dissipatore in alluminio estruso. Ottica in policarbonato metallizzato fascio largo (cod. LA) fascio medio (cod. MD) fascio stretto (cod. ST). Sorgente luminosa LED. Emissione diretta. Sistema di fissaggio a binario (adattatore incluso). Alimentazione elettronica integrata CAE. A richiesta: dimmerabile DALI (cod. DL) specificare se con funzione PUSH DIM (cod. PD).

*Extruded aluminium body painted with epoxy powders after phosphating. Extruded aluminium heatsink. Metallized polycarbonate louver wide beam (code LA) medium beam (code MD) narrow beam (code ST). LED light source. Direct light emission. Track mounting system (adapter included). Built-in electronic driver CAE. On request: dimmable DALI (code DL) PUSH DIM function (code PD) to be requested.*



# FOTOMETRIE | PHOTOMETRIES

## PROIETTORI A BINARIO TRACK LIGHTS

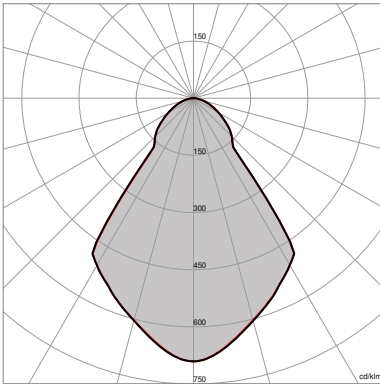

**BEBA** | Fascio/Beam | LA

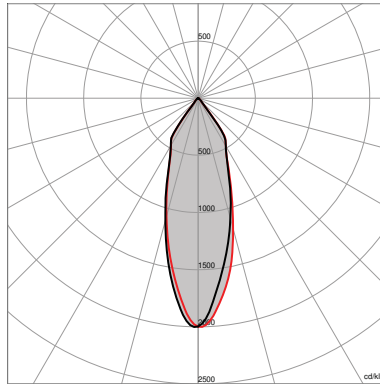

**BEBA** | Fascio/Beam | MD

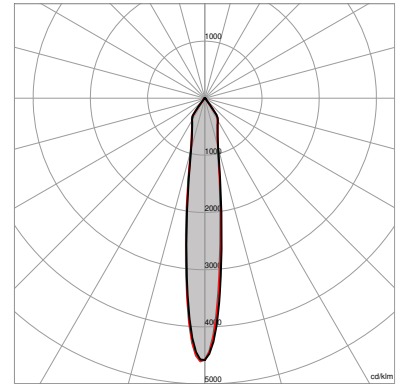

**BEBA** | Fascio/Beam | ST

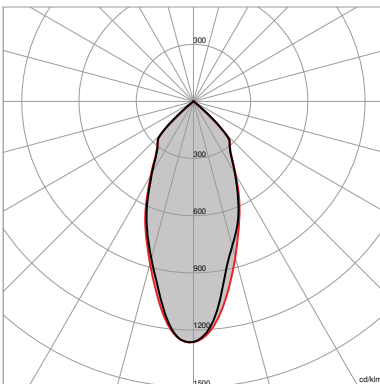

**LERICA** | Fascio/Beam | LA

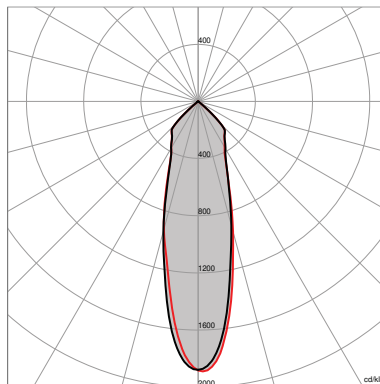

**LERICA** | Fascio/Beam | MD

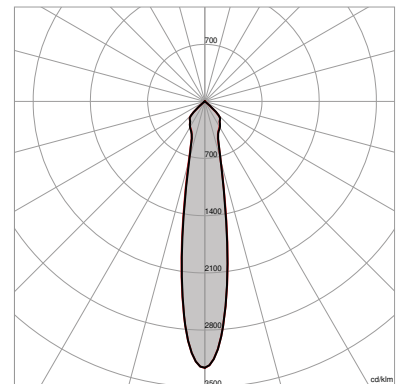

**LERICA** | Fascio/Beam | ST

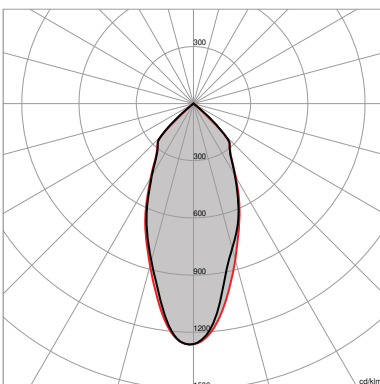

**VALE** | Fascio/Beam | LA

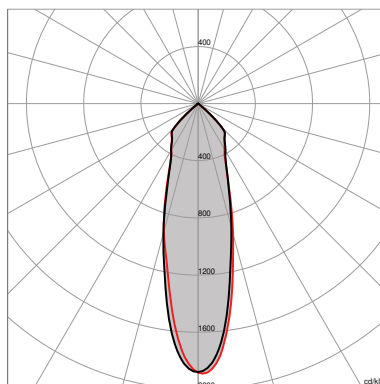

**VALE** | Fascio/Beam | MD

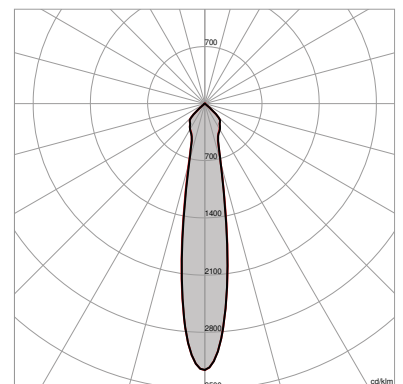

**VALE** | Fascio/Beam | ST



Rimani aggiornato  
Keep up to date

# GAMMA PRODOTTI | PRODUCT RANGE

## PROIETTORI A BINARIO TRACK LIGHTS



### DON

p. 171

Corpo in estruso d'alluminio verniciato con polveri epossidiche previa fosfatazione. Dissipatore in alluminio estruso. Ottica in policarbonato metallizzato fascio largo (cod. LA) fascio medio (cod. MD) fascio stretto (cod. ST). Sorgente luminosa LED. Emissione diretta. Sistema di fissaggio a binario (adattatore incluso). Alimentazione elettronica integrata CAE. A richiesta: dimmerabile DALI (cod. DL) specificare se con funzione PUSH DIM (cod. PD).

*Extruded aluminium body painted with epoxy powders after phosphating. Extruded aluminium heatsink. Metallized polycarbonate louver wide beam (code LA) medium beam (code MD) narrow beam (code ST). LED light source. Direct light emission. Track mounting system (adapter included). Built-in electronic driver CAE. On request: dimmable DALI (code DL) PUSH DIM function (code PD) to be requested.*



### SMILE

p. 172

Corpo in estruso d'alluminio verniciato con polveri epossidiche previa fosfatazione. Dissipatore in alluminio estruso. Ottica in policarbonato metallizzato fascio largo (cod. LA) fascio medio (cod. MD) fascio stretto (cod. ST). Sorgente luminosa LED. Emissione diretta. Sistema di fissaggio a binario (adattatore incluso). Alimentazione elettronica integrata CAE. A richiesta: dimmerabile DALI (cod. DL) specificare se con funzione PUSH DIM (cod. PD).

*Extruded aluminium body painted with epoxy powders after phosphating. Extruded aluminium heatsink. Metallized polycarbonate louver wide beam (code LA) medium beam (code MD) narrow beam (code ST). LED light source. Direct light emission. Track mounting system (adapter included). Built-in electronic driver CAE. On request: dimmable DALI (code DL) PUSH DIM function (code PD) to be requested.*

# FOTOMETRIE | PHOTOMETRIES

## PROIETTORI A BINARIO TRACK LIGHTS

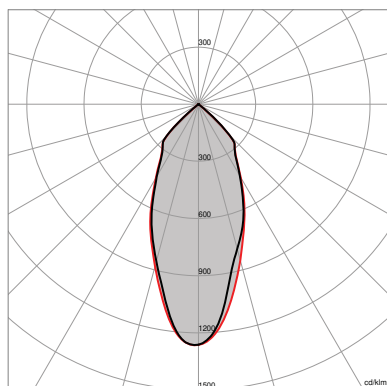

**DON | Fascio/Beam | LA**

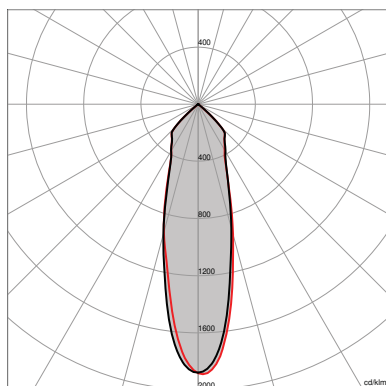

**DON | Fascio/Beam | MD**

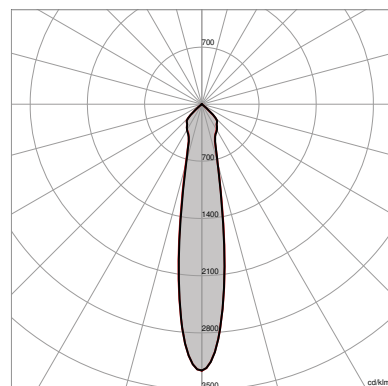

**DON | Fascio/Beam | ST**

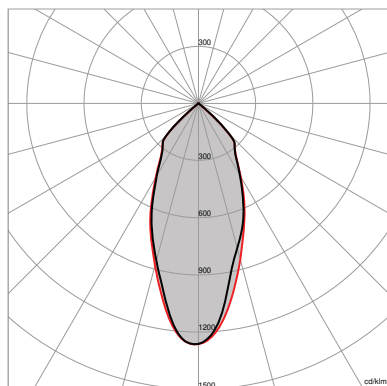

**SMILE | Fascio/Beam | LA**

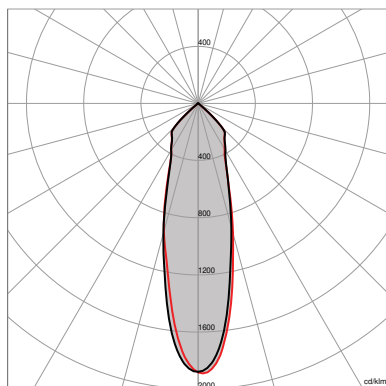

**SMILE | Fascio/Beam | MD**

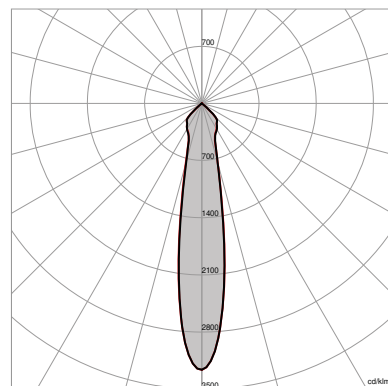

**SMILE | Fascio/Beam | ST**



Rimani aggiornato  
Keep up to date

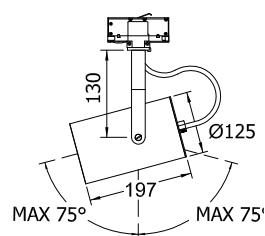
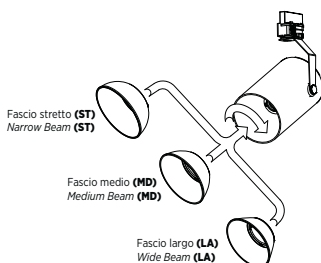

Nota/Note  
Ottiche intercambiabili senza ausilio di utensili  
Interchangeable optics without using of tools

# BEBA

## FASCIO/BEAM LA | MD | ST

Proiettore LED a binario orientabile.  
Adjustable track-mounted LED floodlight.



A RICHIESTA | ON REQUEST

<b>5Y WARRANTY</b> 5% FAILURE RATE	<b>60.000 h</b> LED LIFETIME L90B10	<b>100.000 h</b> LED LIFETIME L70B50
---------------------------------------	--	---

>90 CRI	DL DALI	PD PUSH DIM
------------	------------	----------------

Relamping	Lumen LED*	Watt LED**	Lumen Out***	Watt	Lumen Watt Out	mA	Codice Code	K	Fascio Beam	Alimentazione Power Supply	Colore Colour
1X100 ALO	2100	11,5	1730	12	> 144	350	BA12		<b>ST:</b> fascio stretto narrow beam  <b>MD:</b> fascio medio medium beam  <b>LA:</b> fascio largo wide beam	— : CAE elettronica electronic  <b>DL:</b> DALI (funzione <b>PD</b> **** a richiesta/On request)	<b>01:</b> bianco white
1X35	2700	15	2180	16	> 136	450	BA15				
1X35	3300	19	2620	20	> 131	550	BA20				
1X50	3800	22,5	3050	23,5	> 130	650	BA24				
1X50	4100	25	3260	25,5	> 128	700	BA29				
1X70	4800	30	3880	31,5	> 123	850	BA30				
1X100	5320	35,5	4400	38	> 116	850	BA33				

CE		>80 CRI	IP20 EN 60529	230 V 2014/35/UE	50/60 Hz	850° EN 60695
----	--	------------	------------------	---------------------	-------------	------------------

A++ A+	RG0 EN 62471		01 WHITE
-----------	-----------------	--	-------------

02 BLACK	05 SILVER
-------------	--------------

A richiesta | On request

TEMPERATURA AMBIENTE MIN E MAX | MIN AND MAX ROOM TEMPERATURE: (-10° +40°)

\* Lumen nominali LED max a 25° | Nominal lumen at max 25°

\*\* Potenza dei LED | LED power

\*\*\* Flusso totale in uscita dall'apparecchio a temperatura di lavoro (Ta 25° - 4.000 K) | Total lighting fitting flux output at working temperature (Ta 25° - 4.000 K) | (3.000 K -8% - CRI 90 -10%)

**A RICHIESTA / ON REQUEST**

- Temperatura di colore del LED K diversa da quella specificata. | LED color temperature K different from specified one.
- Riflettore con chiusura in policarbonato trasparente. | Reflector with transparent polycarbonate closure.
- Copertura interna protezione LED | LED protection internal cover
- È possibile utilizzare COB con caratteristiche cromatiche **specifiche**:  
**RETAIL & FOOD** - Carne, pesce, pane, frutta e verdura | **SHOP & STYLE** - CrispWhite, CrispColor, True color. (Vedi pagina 173).  
*Possibility to use cob with specific chromatic characteristics:*  
**RETAIL & FOOD** - Meat, fish, bread, fruit&veg | **SHOP & STYLE** - CrispWhite, CrispColor, True color. (See page 173).
- Cod. **KTBS**: Versione speciale con basetta per installazione a parete/plafone. | Speciale version with base for wall/ceiling mounting system.



Fotometrie | Photometries  
p. 165



Schema di cablaggio | Connection scheme  
p. XXVIII-XXIX



Descrizione prodotto | Product description  
p. 164



Accessori | Accessories  
p. 173



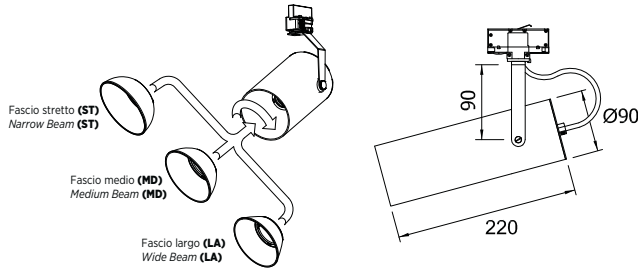

Nota/Note  
 Ottiche intercambiabili senza ausilio di utensili  
 Interchangeable optics without using of tools



# LERICA

## FASCIO/BEAM LA | MD | ST

Proiettore LED a binario orientabile.  
 Adjustable track-mounted LED floodlight.



A RICHIESTA | ON REQUEST



Relamping	Lumen LED*	Watt LED**	Lumen Out***	Watt	Lumen Watt Out	mA	Codice Code	K	Fascio Beam	Alimentazione Power Supply	Colore Colour
1X100 ALO	2100	11,5	1730	12	> 144	350	LA12				
1X35	2700	15	2180	16	> 136	450	LA15				
1X35	3300	19	2620	20	> 131	550	LA20	W: 3.000	ST: fascio stretto narrow beam	— : CAE elettronica electronic	
1X50	3800	22,5	3050	23,5	> 130	650	LA24	N: 4.000	MD: fascio medio medium beam	DL: DALI (funzione PD**** a richiesta/On request)	
1X50	4100	25	3260	25,5	> 128	700	LA29		LA: fascio largo wide beam		O1: bianco white
1X70	4800	30	3880	31,5	> 123	850	LA30				



A richiesta | On request

TEMPERATURA AMBIENTE MIN E MAX | MIN AND MAX ROOM TEMPERATURE: (-10° +40°)

\* Lumen nominali LED max a 25° | Nominal lumen at max 25°

\*\* Potenza dei LED | LED power

\*\*\* Flusso totale in uscita dall'apparecchio a temperatura di lavoro (Ta 25° - 4.000 K) | Total lighting fitting flux output at working temperature (Ta 25° - 4.000 K) | (3.000 K -8% - CRI 90 -10%)

**A RICHIESTA / ON REQUEST**

- Temperatura di colore del LED K diversa da quella specificata. | LED color temperature K different from specified one.
- Riflettore con chiusura in policarbonato trasparente. | Reflector with transparent polycarbonate closure.
- Copertura interna protezione LED | LED protection internal cover
- È possibile utilizzare COB con caratteristiche cromatiche **specifiche**:  
**RETAIL & FOOD** - Carne, pesce, pane, frutta e verdura | **SHOP & STYLE** - CrispWhite, CrispColor, True color. (Vedi pagina 173).  
 Possibility to use cob with **specific** chromatic characteristics:  
**RETAIL & FOOD** - Meat, fish, bread, fruit&veg | **SHOP & STYLE** - CrispWhite, CrispColor, True color. (See page 173).
- Cod. **KTBS**: Versione speciale con basetta per installazione a parete/plafone. | Speciale version with base for wall/ceiling mounting system.



Accessori | Accessories  
 p. 173



Descrizione prodotto | Product description  
 p. 164



Schema di cablaggio | Connection scheme  
 p. XXVIII-XXIX



Fotometrie | Photometries  
 p. 165

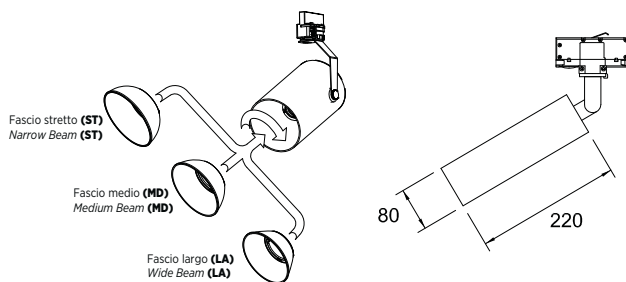

Nota/Note  
Ottiche intercambiabili senza ausilio di utensili  
Interchangeable optics without using of tools

# VALE

## FASCIO/BEAM LA | MD | ST

Proiettore LED a binario orientabile.  
Adjustable track-mounted LED floodlight.



A RICHIESTA | ON REQUEST



<b>5Y WARRANTY</b> 5% FAILURE RATE	<b>60.000 h</b> LED LIFETIME L90B10	<b>100.000 h</b> LED LIFETIME L70B50
---------------------------------------	--	---

Relamping	Lumen LED*	Watt LED**	Lumen Out***	Watt	Lumen Watt Out	mA	Codice Code	K	Fascio Beam	Alimentazione Power Supply	Colore Colour
1X100 ALO	<b>2100</b>	11,5	1730	12	> 144	350	<b>VL12</b>				
1X35	<b>2700</b>	15	2180	16	> 136	450	<b>VL15</b>				
1X35	<b>3300</b>	19	2620	20	> 131	550	<b>VL20</b>	<b>W:</b> 3.000	<b>ST:</b> fascio stretto narrow beam	— : CAE elettronica electronic	
1X50	<b>3800</b>	22,5	3050	23,5	> 130	650	<b>VL24</b>	<b>N:</b> 4.000	<b>MD:</b> fascio medio medium beam	<b>DL:</b> DALI (funzione <b>PD</b> **** a richiesta/On request)	<b>O1:</b> bianco white
1X50	<b>4100</b>	25	3260	25,5	> 128	700	<b>VL29</b>		<b>LA:</b> fascio largo wide beam		
1X70	<b>4800</b>	30	3880	31,5	> 123	850	<b>VL30</b>				

		<b>&gt;80</b> CRI	<b>IP20</b> EN 60529	<b>230 V</b> 2014/35/UE	<b>50/60</b> Hz	<b>850°</b> EN 60695	
	<b>RG0</b> EN 62471		<b>01</b> WHITE				

<b>02</b> BLACK	<b>05</b> SILVER
--------------------	---------------------

A richiesta | On request

TEMPERATURA AMBIENTE MIN E MAX | MIN AND MAX ROOM TEMPERATURE: (-10° +40°)

\* Lumen nominali LED max a 25° | Nominal lumen at max 25°

\*\* Potenza dei LED | LED power

\*\*\* Flusso totale in uscita dall'apparecchio a temperatura di lavoro (Ta 25° - 4.000 K) | Total lighting fitting flux output at working temperature (Ta 25° - 4.000 K) | (3.000 K -8% - CRI 90 -10%)

#### A RICHIESTA / ON REQUEST

- Temperatura di colore del LED K diversa da quella specificata. | LED color temperature K different from specified one.
- Riflettore con chiusura in policarbonato trasparente. | Reflector with transparent polycarbonate closure.
- Copertura interna protezione LED | LED protection internal cover
- È possibile utilizzare COB con caratteristiche cromatiche **specifiche**:  
**RETAIL & FOOD** - Carne, pesce, pane, frutta e verdura | **SHOP & STYLE** - CrispWhite, CrispColor, True color. (Vedi pagina 173).  
Possibility to use cob with **specific** chromatic characteristics:  
**RETAIL & FOOD** - Meat, fish, bread, fruit&veg | **SHOP & STYLE** - CrispWhite, CrispColor, True color. (See page 173).
- Cod. **KTBS**: Versione speciale con basetta per installazione a parete/plafone. | Speciale version with base for wall/ceiling mounting system.



Fotometrie | Photometries  
p. 165



Schema di cablaggio | Connection scheme  
p. XXVIII-XXIX



Descrizione prodotto | Product description  
p. 164



Accessori | Accessories  
p. 173

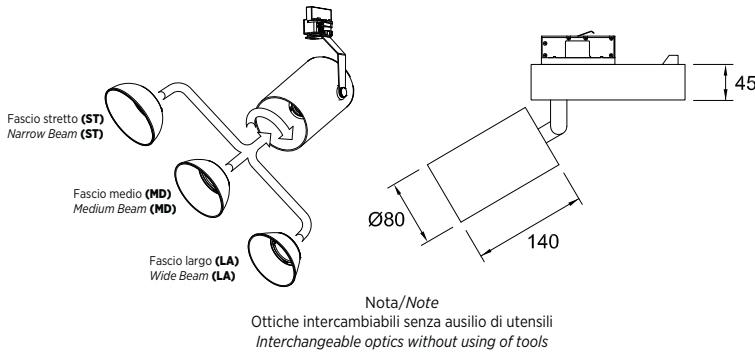

# DON

## FASCIO/BEAM LA | MD | ST

Proiettore LED a binario orientabile.  
Adjustable track-mounted LED floodlight.



A RICHIESTA | ON REQUEST



<b>5Y WARRANTY</b> 5% FAILURE RATE	<b>60.000 h</b> LED LIFETIME L90B10	<b>100.000 h</b> LED LIFETIME L70B50
---------------------------------------	--	---

Relamping	Lumen LED*	Watt LED**	Lumen Out***	Watt	Lumen Watt Out	mA	Codice Code	K	Fascio Beam	Alimentazione Power Supply	Colore Colour
1X100 ALO	<b>2100</b>	11,5	1730	12	> 144	350	<b>D012</b>				
1X35	<b>2700</b>	15	2180	16	> 136	450	<b>D015</b>				
1X35	<b>3300</b>	19	2620	20	> 131	550	<b>D020</b>	W: 3.000	ST: fascio stretto narrow beam	— : CAE elettronica electronic	O1: bianco white
1X50	<b>3800</b>	22,5	3050	23,5	> 130	650	<b>D024</b>	N: 4.000	MD: fascio medio medium beam	DL: DALI (funzione PD**** a richiesta/On request)	
1X50	<b>4100</b>	25	3260	25,5	> 128	700	<b>D029</b>		LA: fascio largo wide beam		
1X70	<b>4800</b>	30	3880	31,5	> 123	850	<b>D030</b>				

CE	⊕	>80 CRI	IP20 EN 60529	230 V 2014/35/UE	50/60 Hz	850° EN 60695
----	---	---------	---------------	------------------	----------	---------------

A++ A	RG0 EN 62471	01 WHITE
-------	--------------	----------

02 BLACK	05 SILVER
----------	-----------

A richiesta | On request

TEMPERATURA AMBIENTE MIN E MAX | MIN AND MAX ROOM TEMPERATURE: (-10° +40°)

\* Lumen nominali LED max a 25° | Nominal lumen at max 25°

\*\* Potenza dei LED | LED power

\*\*\* Flusso totale in uscita dall'apparecchio a temperatura di lavoro (Ta 25° - 4.000 K) | Total lighting fitting flux output at working temperature (Ta 25° - 4.000 K) | (3.000 K -8% - CRI 90 -10%)

**A RICHIESTA / ON REQUEST**

- Temperatura di colore del LED K diversa da quella specificata. | LED color temperature K different from specified one.
- Riflettore con chiusura in policarbonato trasparente. | Reflector with transparent polycarbonate closure.
- Copertura interna protezione LED | LED protection internal cover
- È possibile utilizzare COB con caratteristiche cromatiche **specifiche**:  
**RETAIL & FOOD** - Carne, pesce, pane, frutta e verdura | **SHOP & STYLE** - CrispWhite, CrispColor, True color. (Vedi pagina 173).  
*Possibility to use cob with **specific** chromatic characteristics:*  
**RETAIL & FOOD** - Meat, fish, bread, fruit&veg | **SHOP & STYLE** - CrispWhite, CrispColor, True color. (See page 173).

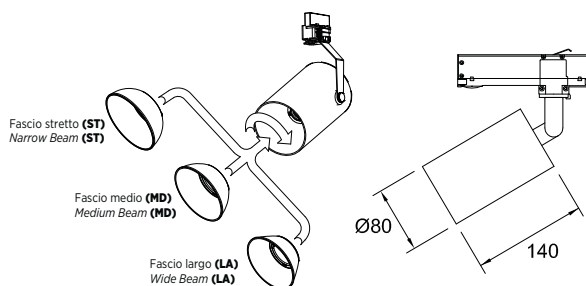

Nota/Note  
Ottiche intercambiabili senza ausilio di utensili  
Interchangeable optics without using of tools

# SMILE

## FASCIO/BEAM LA | MD | ST

Proiettore LED a binario orientabile.  
Adjustable track-mounted LED floodlight.



**5Y WARRANTY**  
5% FAILURE RATE

**60.000 h**  
LED LIFETIME L90B10

**100.000 h**  
LED LIFETIME L70B50

A RICHIESTA | ON REQUEST



Relamping	Lumen LED*	Watt LED**	Lumen Out***	Watt	Lumen Watt Out	mA	Codice Code	K	Fascio Beam	Alimentazione Power Supply	Colore Colour
1X100 ALO	<b>2100</b>	11,5	1730	12	> 144	350	<b>SML12</b>				
1X35	<b>2700</b>	15	2180	16	> 136	450	<b>SML15</b>	W: 3.000 N: 4.000	ST: fascio stretto narrow beam	— : CAE	O1: bianco white
1X35	<b>3300</b>	19	2620	20	> 131	550	<b>SML20</b>		MD: fascio medio medium beam	A RICHIESTA   ON REQUEST DL: DALI PD: PUSH DIM	
1X50	<b>3800</b>	22,5	3050	23,5	> 130	650	<b>SML24</b>		LA: fascio largo wide beam		
1X50	<b>4100</b>	25	3260	25,5	> 128	700	<b>SML29</b>				



A richiesta | On request

TEMPERATURA AMBIENTE MIN E MAX | MIN AND MAX ROOM TEMPERATURE: (-10° +40°W)

\* Lumen nominali LED max a 25° | Nominal lumen at max 25°

\*\* Potenza dei LED | LED power

\*\*\* Flusso totale in uscita dall'apparecchio a temperatura di lavoro (Ta 25° - 4.000 K) | Total lighting fitting flux output at working temperature (Ta 25° - 4.000 K) | (3.000 K -8% - CRI 90 -10%)





#### A RICHIESTA / ON REQUEST

- Temperatura di colore del LED K diversa da quella specificata. | LED color temperature K different from specified one.
- Riflettore con chiusura in policarbonato trasparente. | Reflector with transparent polycarbonate closure.
- Copertura interna protezione LED | LED protection internal cover
- È possibile utilizzare COB con caratteristiche cromatiche **specifiche**:  
**RETAIL & FOOD** - Carne, pesce, pane, frutta e verdura | **SHOP & STYLE** - CrispWhite, CrispColor, True color. (Vedi pagina 173).



Possibilità di usare cob with **specific** chromatic characteristics:

**RETAIL & FOOD** - Meat, fish, bread, fruit&veg | **SHOP & STYLE** - CrispWhite, CrispColor, True color. (See page 173).



DESCRIZIONE ACCESSORIO ACCESSORY DESCRIPTION	IDONEO PER: SUITABLE FOR:	CODICE CODE
	<p>Versione speciale con basetta. <i>Special version with ceiling mounting base.</i></p>	<p>BEBA, LERICA <b>KTBS</b></p>
	<p>ILLUMINAZIONE SPECIALE: È possibile utilizzare COB con caratteristiche cromatiche specifiche: RETAIL &amp; FOOD – Carne, pesce, pane, frutta e verdura. SHOP &amp; STYLE – CrispWhite, CrispColor, True color.</p> <p>SPECIAL LIGHTING: <i>Possibility to use cob with specific chromatic characteristics:</i> RETAIL &amp; FOOD – Meat, fish, bread, fruit&amp;veg. SHOP &amp; STYLE – CrispWhite, CrispColor, True color.</p>	<p>BEBA, LERICA, VALE, DON, SMILE -</p>
	<p>Filtro: Pane, Carne, Pesce, Verdura.</p> <p>Filter: <i>Meat, fish, bread, fruit&amp;veg.</i></p>	<p>BEBA, LERICA, DON, SMILE -</p>
	<p>Filtro: Anti abbagliamento.</p> <p>Filter: <i>Antiglare.</i></p>	<p>BEBA, LERICA, DON, SMILE -</p>

**ACCESSORI | ACCESOIRES**

DESCRIZIONE ACCESSORIO ACCESSORY DESCRIPTION	IDONEO PER: SUITABLE FOR:	CODICE CODE
	<p>Basetta monofase + DALI, per il fissaggio a plafone dell'adattatore. <i>Single phase + DALI base, for adapter ceiling mounting.</i></p>	<p>BEBA, LERICA, VALE <b>KT 900/BP-D-B</b> <b>KT 900/BP-D-G</b> <b>KT 900/BP-D-W</b></p>
	<p>Adattatore per il fissaggio nel controsoffitto della basetta KT9000/BP-... <i>Adapter for base KT9000/BP-... recessed mounting.</i></p>	<p>BEBA, LERICA, VALE <b>KT 9000/BR-B</b> <b>KT 9000/BR-G</b> <b>KT 9000/BR-W</b></p>



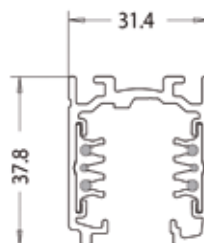
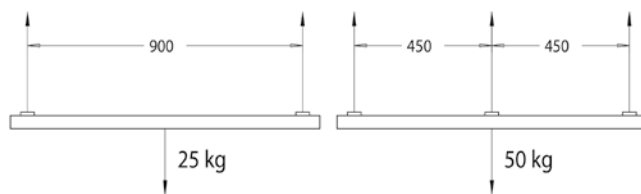

# BINARIO DALI

Binario elettrificato realizzato in profilo di alluminio a sezione quadrata. Il binario si presenta con una linea semplice ma tecnica.  
 Electrified track manufactured in square profile extruded aluminium.  
 Electrified track has a simple but highly technical shape.

**5Y WARRANTY**  
5% FAILURE RATE

**60.000 h**  
LED LIFETIME L90B10

**100.000 h**  
LED LIFETIME L70B50

Codice Code	Lunghezza Length	Colore Colour
7511/10	1000	<b>31:</b> bianco   white RAL9016
7511/20	2000	<b>30:</b> nero   black RAL 9005
7511/30	3000	<b>42:</b> anodizzato   anodized

## POSIZIONAMENTO DELL'ALIMENTAZIONE DEL CONDUTTORI DI TERRA. POSITION OF THE SUPPLY OF EARTH CONDUCTORS.

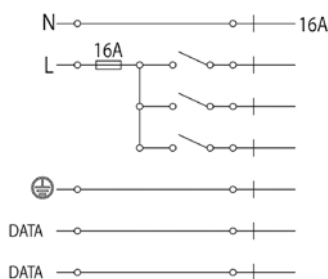

SCHEMA ELETTRICO MONOFASE A TENSIONE DI RETE 230/250V.  
 ONE-PHASE ELECTRIC DIAGRAM FOR MAINS VOLTAGE 230/250V.

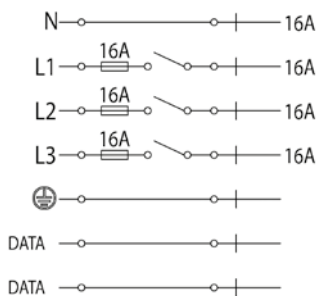

SCHEMA ELETTRICO TRIFASE A TENSIONE DI RETE 230/250V.  
 THREE-PHASE ELECTRIC DIAGRAM FOR MAINS VOLTAGE 230/250V.

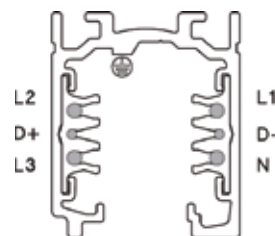

accessori accessories		codice code
	Adattatore meccanico 6A - carico meccanico 5 Kg. <i>Mechanical electrical adapter 6A - mechanical load 5 Kg.</i>	<b>7601-00</b>
	Adattatore meccanico. <i>Mechanical electrical adapter.</i>	<b>7625-00</b>
	Alimentazione destra. <i>Right power supply.</i>	<b>7652-10</b>
	Alimentazione sinistra. <i>Left power supply.</i>	<b>7652-11</b>
	Alimentazione centrale e giunto lineare. <i>Central connector and straight joint.</i>	<b>7653-10</b>
	Giunto L interno. <i>Interior L joint.</i>	<b>7655-10</b>
	Giunto L esterno. <i>Exterior L joint.</i>	<b>7655-11</b>
	Giunto T sinistro esterno. <i>Left outside T joint.</i>	<b>7656-10</b>
	Giunto T destro esterno. <i>Right outside T joint.</i>	<b>7656-12</b>
	Giunto T destro interno. <i>Right inside T joint.</i>	<b>7656-13</b>
	Giunto T sinistro interno. <i>Left inside T joint.</i>	<b>7656-11</b>
	Giunto X. <i>X joint.</i>	<b>7657-10</b>

accessori accessories		codice code
	Giunto flessibile. <i>Flexible joint.</i>	<b>7658-10</b>
	Giunto lineare con contatti. <i>Electrical straight joint.</i>	<b>7604-10</b>
	Giunto lineare senza contatti. <i>Mechanical joint.</i>	<b>7654-10</b>
	Chiusura. <i>End cap.</i>	<b>7659-00</b>
	Copertura binario 1000 mm. <i>Track cover 1000 mm.</i>	<b>7624-00</b>
	Kit attacco soffitto. <i>Ceiling kit.</i>	<b>7607-00</b>
	Sospensione kit cavo acciaio 2000 mm (piattina 60). <i>Suspension kit with steel wire 2000 mm (plate 60).</i>	<b>7606-00</b>
	Sospensione kit cavo acciaio 2000 mm (piattina 120). <i>Suspension kit with steel wire 2000 mm (plate 120).</i>	<b>7606-05</b>
	Piattina 120 mm. <i>Plate 120 mm.</i>	<b>7606-04</b>
	Piattina 60 mm. <i>Plate 60 mm.</i>	<b>7606-02</b>
	Adattatore con trasformatore elettr. 50W con jack femmina. <i>Adapter with transformer 50W with female jack.</i>	<b>7601-11</b>

FOCUS PRODOTTO | PRODUCT FOCUS

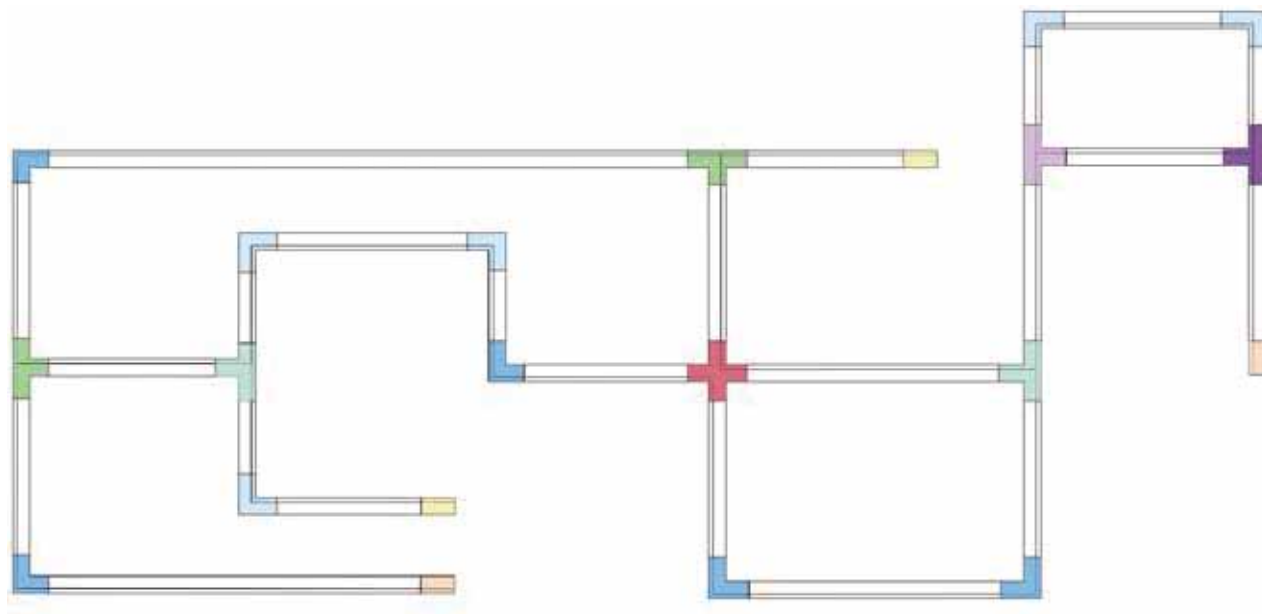





Apparecchi a sospensione e plafone idonei per la realizzazione di file luminose continue.

*Suspension and ceiling LED lighting fittings suitable for continuous line application.*





## SISTEMI CONTINUI CONTINUOUS LINE SYSTEMS

Apparecchi LED per aree commerciali, negozi, uffici e scuole.  
*LED lighting fittings for commercial areas, showrooms, offices and schools.*



# GAMMA PRODOTTI | PRODUCT RANGE

## SISTEMI CONTINUI CONTINUOUS LINE SYSTEMS



### BINGO

p. 182

Corpo in lamiera d'acciaio pressopiegata vernicata con polveri epossidiche previa fosfatazione con vano passacavi. Diffusore in policarbonato microprismato (a richiesta opale). Sorgente luminosa a LED. Emissione diretta. Sistema di fissaggio a sospensione o plafone. Alimentazione elettronica CAE. A richiesta: dimmerabile DALI (cod. DL) specificare se con funzione PUSH DIM (cod. PD).

*Bent sheet steel body painted with epoxy powders after phosphating with cable compartment. Microprismatic polycarbonate diffuser (on request opal). LED light source. Direct light emission. Suspension or ceiling fixing system. Built-in electronic driver CAE. On request: dimmable DALI (code DL) PUSH DIM function (code PD) to be requested.*



### BINGO SYSTEM LED

p. 184

Corpo in lamiera d'acciaio pressopiegata vernicata con polveri epossidiche previa fosfatazione con vano passacavi. Diffusore in policarbonato microprismato (a richiesta opale). **Linea di alimentazione in cascata a 7 poli N07V-K, di sez. 1,5 mm<sup>2</sup> con presa/spina all'estremità, a innesto rapido e ganci di sicurezza. Diramazioni a più vie, con presa a innesto rapido a 2 poli per il collegamento elettrico degli elementi ausiliari a selezione di fase. Barre cablate con possibilità di selezione di accensione. Per tutte le versioni, conformità alla norma CEI EN 60598-1.** Sorgente luminosa a LED. Emissione diretta. Sistema di fissaggio a sospensione o plafone. Alimentazione elettronica CAE. A richiesta: dimmerabile DALI (cod. DL) specificare se con funzione PUSH DIM (cod. PD).

*Bent sheet steel body painted with epoxy powders after phosphating with cable compartment. Microprismatic polycarbonate diffuser (on request opal). **7 poles N07V-K feeding line, sec. 1,5 mm<sup>2</sup> with plug/connector at the end, quick-release and safety clips. Multi-way branches, with 2-pole fast-coupling terminal block for the electrical connection of the auxiliary elements, with the possibility to obtain different configurations. All version comply with IEC 60598-1.** LED light source. Direct light emission. Suspension or ceiling fixing system. Built-in electronic driver CAE. On request: dimmable DALI (code DL) PUSH DIM function (code PD) to be requested.*



### BINGO SYSTEM LED PLUS

p. 186

Corpo in lamiera d'acciaio pressopiegata vernicata con polveri epossidiche previa fosfatazione con vano passacavi. Diffusore in policarbonato microprismato (a richiesta opale). Riflettore in alluminio speculare. **Linea di alimentazione in cascata a 7 poli N07V-K, di sez. 1,5 mm<sup>2</sup> con presa/spina all'estremità, a innesto rapido e ganci di sicurezza. Diramazioni a più vie, con presa a innesto rapido a 2 poli per il collegamento elettrico degli elementi ausiliari a selezione di fase. Barre cablate con possibilità di selezione di accensione. Per tutte le versioni, conformità alla norma CEI EN 60598-1.** Sorgente luminosa a LED. Emissione diretta. Sistema di fissaggio a sospensione o plafone. Alimentazione elettronica CAE. A richiesta: dimmerabile DALI (cod. DL) specificare se con funzione PUSH DIM (cod. PD).

*Bent sheet steel body painted with epoxy powders after phosphating with cable compartment. Microprismatic polycarbonate diffuser (on request opal). Specular aluminum reflector. **7 poles N07V-K feeding line, sec. 1,5 mm<sup>2</sup> with plug/connector at the end, quick-release and safety clips. Multi-way branches, with 2-pole fast-coupling terminal block for the electrical connection of the auxiliary elements, with the possibility to obtain different configurations. All version comply with IEC 60598-1.** LED light source. Direct light emission. Suspension or ceiling fixing system. Built-in electronic driver CAE. On request: dimmable DALI (code DL) PUSH DIM function (code PD) to be requested.*

# FOTOMETRIE | PHOTOMETRIES

## SISTEMI CONTINUI CONTINUOUS LINE SYSTEMS

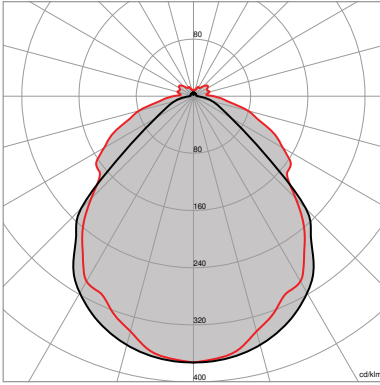

**BINGO**

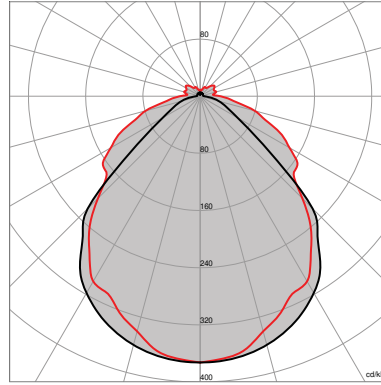

**BINGO SYSTEM LED**

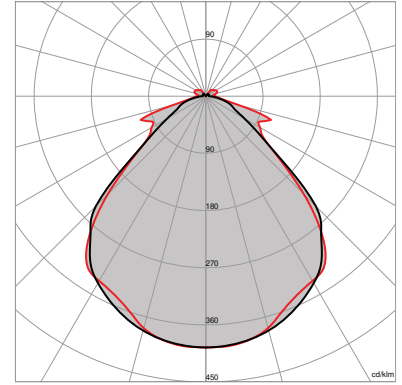

**BINGO SYSTEM LED PLUS**



Rimani aggiornato  
Keep up to date



# GAMMA PRODOTTI | PRODUCT RANGE

## SISTEMI CONTINUI CONTINUOUS LINE SYSTEMS



### BINLENS SYSTEM EX

p. 188

Corpo in lamiera d'acciaio pressopiegata vernicata con polveri epossidiche previa fosfatazione con vano passacavi. Ottica lenticolare diffondente. **Linea di alimentazione in cascata a 7 poli N07V-K, di sez. 1,5 mm<sup>2</sup> con presa/spina all'estremità, a innesto rapido e ganci di sicurezza. Diramazioni a più vie, con presa a innesto rapido a 2 poli per il collegamento elettrico degli elementi ausiliari a selezione di fase. Barre cablate con possibilità di selezione di accensione. Per tutte le versioni, conformità alla norma CEI EN 60598-1.** Sorgente luminosa a LED. Emissione diretta. Sistema di fissaggio a sospensione o plafone. Alimentazione elettronica CAE. A richiesta: dimmerabile DALI (cod. DL) specificare se con funzione PUSH DIM (cod. PD).

*Bent sheet steel body painted with epoxy powders after phosphating with cable compartment. Lenticular optical wide. 7 poles N07V-K feeding line, sec. 1,5 mm<sup>2</sup> with plug/connector at the end, quick-release and safety clips. Multi-way branches, with 2-pole fast-coupling terminal block for the electrical connection of the auxiliary elements, with the possibility to obtain different configurations. All version comply with IEC 60598-1. LED light source. Direct light emission. Suspension or ceiling fixing system. Built-in electronic driver CAE. On request: dimmable DALI (code DL) PUSH DIM function (code PD) to be requested.*



### BINLENS SYSTEM ST

p. 189

Corpo in lamiera d'acciaio pressopiegata vernicata con polveri epossidiche previa fosfatazione con vano passacavi. Ottica lenticolare concentrante. **Linea di alimentazione in cascata a 7 poli N07V-K, di sez. 1,5 mm<sup>2</sup> con presa/spina all'estremità, a innesto rapido e ganci di sicurezza. Diramazioni a più vie, con presa a innesto rapido a 2 poli per il collegamento elettrico degli elementi ausiliari a selezione di fase. Barre cablate con possibilità di selezione di accensione. Per tutte le versioni, conformità alla norma CEI EN 60598-1.** Sorgente luminosa a LED. Emissione diretta. Sistema di fissaggio a sospensione o plafone. Alimentazione elettronica CAE. A richiesta: dimmerabile DALI (cod. DL) specificare se con funzione PUSH DIM (cod. PD).

*Bent sheet steel body painted with epoxy powders after phosphating with cable compartment. Lenticular optical narrow. 7 poles N07V-K feeding line, sec. 1,5 mm<sup>2</sup> with plug/connector at the end, quick-release and safety clips. Multi-way branches, with 2-pole fast-coupling terminal block for the electrical connection of the auxiliary elements, with the possibility to obtain different configurations. All version comply with IEC 60598-1. LED light source. Direct light emission. Suspension or ceiling fixing system. Built-in electronic driver CAE. On request: dimmable DALI (code DL) PUSH DIM function (code PD) to be requested.*



### BINLENS SYSTEM BT

p. 190

Corpo in lamiera d'acciaio pressopiegata vernicata con polveri epossidiche previa fosfatazione con vano passacavi. Ottica lenticolare batwing. **Linea di alimentazione in cascata a 7 poli N07V-K, di sez. 1,5 mm<sup>2</sup> con presa/spina all'estremità, a innesto rapido e ganci di sicurezza. Diramazioni a più vie, con presa a innesto rapido a 2 poli per il collegamento elettrico degli elementi ausiliari a selezione di fase. Barre cablate con possibilità di selezione di accensione. Per tutte le versioni, conformità alla norma CEI EN 60598-1.** Sorgente luminosa a LED. Emissione diretta. Sistema di fissaggio a sospensione o plafone. Alimentazione elettronica CAE. A richiesta: dimmerabile DALI (cod. DL) specificare se con funzione PUSH DIM (cod. PD).

*Bent sheet steel body painted with epoxy powders after phosphating with cable compartment. Lenticular optical batwing. 7 poles N07V-K feeding line, sec. 1,5 mm<sup>2</sup> with plug/connector at the end, quick-release and safety clips. Multi-way branches, with 2-pole fast-coupling terminal block for the electrical connection of the auxiliary elements, with the possibility to obtain different configurations. All version comply with IEC 60598-1. LED light source. Direct light emission. Suspension or ceiling fixing system. Built-in electronic driver CAE. On request: dimmable DALI (code DL) PUSH DIM function (code PD) to be requested.*



# FOTOMETRIE | PHOTOMETRIES

## SISTEMI CONTINUI CONTINUOUS LINE SYSTEMS

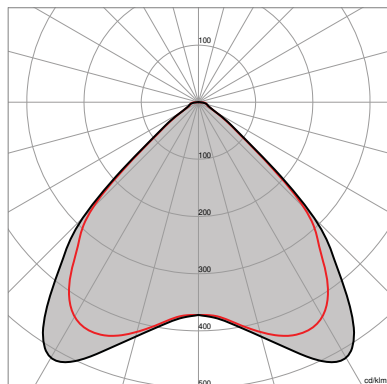

**BINLENS | Ottica/Optic | EX**

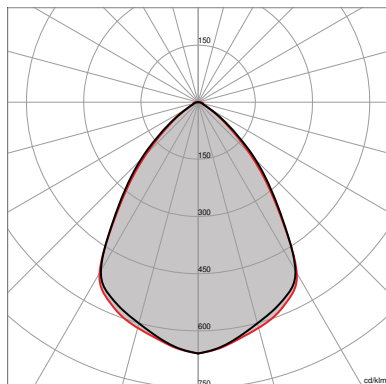

**BINLENS | Ottica/Optic | ST**

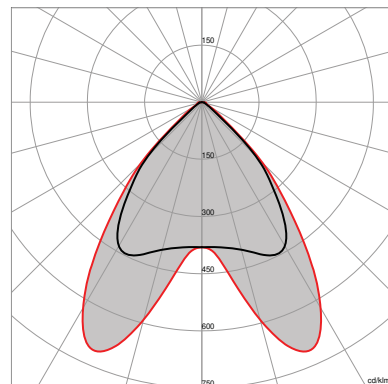

**BINLENS | Ottica/Optic | BT**



Rimani aggiornato  
Keep up to date

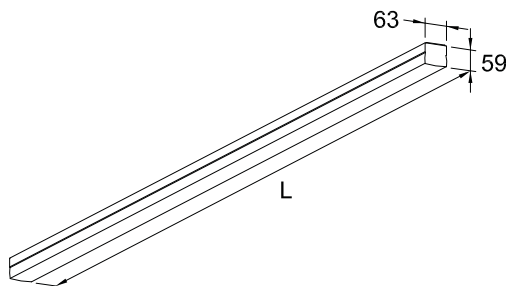

# BINGO LED MICROPRISMATO/MICROPRISMATIC

Plafoniera per montaggio a sospensione accessorio **BDS-KS compreso** o plafone **BDS-KSP a richiesta** (vedi pagina 210). Testate di chiusura comprese.

*Suspension light fitting (accessory **BDS-KS included**) or surface light fitting (accessory **BDS-KSP on request**). See page 210. End covers included on both cases.*



**A RICHIESTA | ON REQUEST**

<b>5Y WARRANTY</b> 5% FAILURE RATE	<b>60.000 h</b> LED LIFETIME <b>L90B10</b>	<b>100.000 h</b> LED LIFETIME <b>L70B50</b>
---------------------------------------	---	--

<b>&gt;90</b> CRI	<b>EM</b> EN 60980-2-22	<b>DL</b> DALI	<b>PD</b> PUSH DIM
----------------------	----------------------------	-------------------	-----------------------

Relamping	Lumen LED*	Watt LED**	Lumen OUT***	Watt	Lumen Watt OUT	L Lunghezza L Length	Configurazione LED LED configuration	Codice Code	K	Alimentazione Power Supply	Colore Colour
1x28	<b>2050</b>	10	1620	11	> 147	750 mm	—	<b>BDL13</b>	N: 4.000	— : CAE A RICHIESTA   ON REQUEST <b>DL</b> : DALI <b>PD</b> : PUSH DIM	<b>01</b> : bianco white
1x28	<b>2650</b>	13,5	2090	14,5	> 144	750 mm	—	<b>BDL15</b>			
1x36	<b>2870</b>	16	2267	17	> 133	750 mm	—	<b>BDL17</b>			
1x36	<b>3075</b>	16	4990	17	> 147	1125 mm	—	<b>BDL18</b>			
1x54	<b>3450</b>	20,5	3168	22	> 144	1125 mm	—	<b>BDL22</b>			
1x58	<b>4300</b>	23,5	3340	25	> 133	1125 mm	—	<b>BDL25</b>			
1x49	<b>4100</b>	20	3240	22	> 147	1500 mm	—	<b>BDL26</b>			
1x58	<b>5270</b>	27	4176	29	> 144	1500 mm	—	<b>BDL30</b>			
1x72	<b>5750</b>	32	4525	34	> 133	1500 mm	—	<b>BDL34</b>			
2x28	<b>4100</b>	20	3240	22	> 147	750 mm	≡	<b>BDL226</b>			
2x28	<b>5300</b>	27	4180	29	> 144	750 mm	≡	<b>BDL230</b>			
2x36	<b>5740</b>	32	4530	34	> 133	750 mm	≡	<b>BDL234</b>			
2x36	<b>6150</b>	32	4998	34	> 147	1125 mm	≡	<b>BDL236</b>			
2x54	<b>7900</b>	41	6336	44	> 144	1125 mm	≡	<b>BDL244</b>			
2x58	<b>8600</b>	47	6680	50	> 133	1125 mm	≡	<b>BDL250</b>			
2x49	<b>8200</b>	40	6480	44	> 147	1500 mm	≡	<b>BDL249</b>			
2x58	<b>10540</b>	54	8352	58	> 144	1500 mm	≡	<b>BDL258</b>			
1x72	<b>11480</b>	64	9050	68	> 133	1500 mm	≡	<b>BDL264</b>			

<b>CE</b>	<b>&gt;80</b> CRI	<b>IP50</b> EN 60529	<b>230 V</b> 2014/35/UE	<b>50/60</b> Hz	<b>IK 07</b> EN 60068
<b>850°</b> EN 60695	<b>RG 0</b> EN 62471	<b>01</b> WHITE	<b>19</b> UGR		

TEMPERATURA AMBIENTE MIN E MAX | MIN AND MAX ROOM TEMPERATURE: **(-10° +40°)**

\* Lumen nominali LED max a 25° | Nominal lumen at max 25°

\*\* Potenza dei LED | LED power

\*\*\* Flusso totale in uscita dall'apparecchio a temperatura di lavoro (Ta 25° - 4.000 K) | Total lighting fitting flux output at working temperature (Ta 25° - 4.000 K) | (3.000 K -8% - CRI 90 -10%)

Fotometrie | Photometries  
p. 179

Schema di cablaggio | Connection scheme  
p. XXVIII-XXIX

Descrizione prodotto | Product description  
p. 178

Accessori | Accessories  
p. 196-199





**UFFICI** | ITALIA  
**OFFICES** | ITALY



**SCUOLA** | TREZZO SULL'ADDA  
**SCHOOL** | TREZZO SULL'ADDA



**SCUOLA** | TREZZO SULL'ADDA  
**SCHOOL** | TREZZO SULL'ADDA



**MAGAZZINO**  
**WAREHOUSE**



**BIBLIOTECA** | REPUBBLICA CECA  
**LIBRARY** | CZECH REPUBLIC



**SUPERMERCATO CRAI** | LUCCA  
**MARKET** | LUCCA

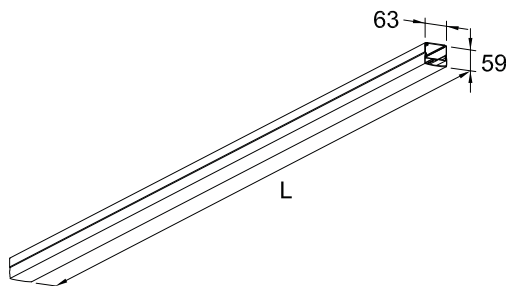

# BINGO SYSTEM LED

## MICROPRISMATO/MICROPRISMATIC

Sistema fila continua a LED per l'illuminazione di aree commerciali ed industriali.  
**Linea di alimentazione passante 7x1,5mm<sup>2</sup> con spinotti ad innesto rapido e selezione di fase.**  
*Continuous line LED lighting system for commercial and industrial areas.*  
*Passing power line 7x1,5 mm<sup>2</sup> with quick connectors and phase selection.*



**A RICHIESTA | ON REQUEST**



<b>5Y WARRANTY</b> 5% FAILURE RATE	<b>60.000 h</b> LED LIFETIME L90B10	<b>100.000 h</b> LED LIFETIME L70B50
---------------------------------------	--	---

Relamping	Lumen LED*	Watt LED**	Lumen OUT***	Watt	Lumen Watt OUT	L Lunghezza L Length	Accensioni/Configurazione LED LED switching on /configuration	Codice Code	K	Alimentazione Power Supply	Colore Colour
1x58	<b>4100</b>	20	3240	22	> 147	1500 mm	—	<b>BDS124</b>	N: 4.000	— : CAE A RICHIESTA   ON REQUEST <b>DL:</b> DALI <b>PD:</b> PUSH DIM	<b>01:</b> bianco white
1x72	<b>5270</b>	27	4176	29	> 144	1500 mm	—	<b>BDS129</b>			
1x80	<b>5750</b>	32	4525	34	> 133	1500 mm	—	<b>BDS133</b>			
1+1x58	<b>8200</b>	40	6480	44	> 147	3000 mm	— —	<b>BDS1149</b>	N: 4.000	— : CAE A RICHIESTA   ON REQUEST <b>DL:</b> DALI <b>PD:</b> PUSH DIM	<b>01:</b> bianco white
1+1x72	<b>10540</b>	54	8352	58	> 144	3000 mm	— —	<b>BDS1158</b>			
1+1x80	<b>11500</b>	64	9050	68	> 133	3000 mm	— —	<b>BDS1164</b>			
2x58	<b>8200</b>	40	6480	44	> 147	1500 mm	==	<b>BDS249</b>	N: 4.000	— : CAE A RICHIESTA   ON REQUEST <b>DL:</b> DALI <b>PD:</b> PUSH DIM	<b>01:</b> bianco white
2x72	<b>10540</b>	54	8352	58	> 144	1500 mm	==	<b>BDS258</b>			
2x80	<b>11500</b>	64	9050	68	> 133	1500 mm	==	<b>BDS264</b>			
2+2x58	<b>16400</b>	80	12960	88	> 147	3000 mm	== —	<b>BDS298</b>	N: 4.000	— : CAE A RICHIESTA   ON REQUEST <b>DL:</b> DALI <b>PD:</b> PUSH DIM	<b>01:</b> bianco white
2+2x72	<b>21680</b>	108	16700	116	> 144	3000 mm	== —	<b>BDS2116</b>			
2+2x80	<b>23000</b>	128	18100	136	> 133	3000 mm	== —	<b>BDS2128</b>			



Fotometrie | Photometries  
p. 179



Schema di cablaggio | Connection scheme  
p. XXVIII-XXIX



Descrizione prodotto | Product description  
p. 178



Accessori | Accessories  
p. 196-199



Relamping	Lumen LED*	Watt LED**	Lumen OUT***	Watt	Lumen Watt OUT	L Lunghezza L Length	Accensioni/Configurazione LED LED switching on/configuration	Codice Code	K	Alimentazione Power Supply	Colore Colour
2x58	<b>8200</b>	40	6480	44	> 147	1500 mm		<b>BDS2249</b>	N: 4.000	— : CAE A RICHIESTA   ON REQUEST <b>DL</b> : DALI <b>PD</b> : PUSH DIM	<b>01</b> : bianco white
2x72	<b>10540</b>	54	8352	58	> 144	1500 mm		<b>BDS2258</b>			
2x80	<b>11500</b>	64	9050	68	> 133	1500 mm		<b>BDS2264</b>			
2+2x58	<b>15680</b>	88	12560	92	> 137	3000 mm		<b>BDS2498</b>	N: 4.000	— : CAE A RICHIESTA   ON REQUEST <b>DL</b> : DALI <b>PD</b> : PUSH DIM	<b>01</b> : bianco white
2+2x72	<b>18800</b>	108	15260	114	> 134	3000 mm		<b>BDS24116</b>			
2+2x80	<b>21600</b>	128	17300	132	> 131	3000 mm		<b>BDS24128</b>			

**05**  
SILVER

A richiesta | On request

TEMPERATURA AMBIENTE MIN E MAX | MIN AND MAX ROOM TEMPERATURE: (-10° +40°)

\* Lumen nominali LED max a 25° | Nominal lumen at max 25°

\*\* Potenza dei LED | LED power

\*\*\* Flusso totale in uscita dall'apparecchio a temperatura di lavoro (Ta 25° - 4.000 K) | Total lighting fitting flux output at working temperature (Ta 25° - 4.000 K) | (3.000 K -8% - CRI 90 -10%)

Schemi di accensione e collegamenti | Switching on and connection scheme: (pp. 206)

Accensione 1 | Switching on 1  
 Accensione 2 | Switching on 2

**A RICHIESTA / ON REQUEST**

- A richiesta sono disponibili apparecchi con diverse tipologie di accensione (per maggiori informazioni contattare il ns Ufficio Tecnico) | Fixtures with different switching on are available on request (for more details contact our Technical Department)



Accessori | Accessories  
p. 196-199



Descrizione prodotto | Product description  
p. 178



Schema di cablaggio | Connection scheme  
p. XXVIII-XXIX



Fotometrie | Photometries  
p. 179

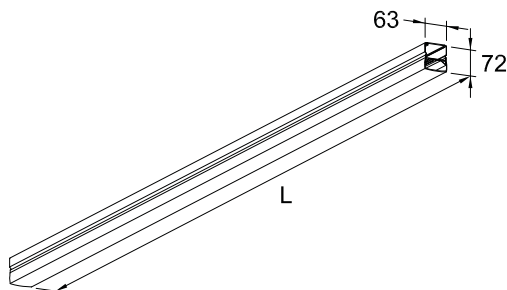

# BINGO SYSTEM LED PLUS MICROPRISMATO/MICROPRISMATIC

Sistema fila continua a LED per l'illuminazione di aree commerciali ed industriali.  
**Linea di alimentazione passante 7x1,5mm<sup>2</sup> con spinotti ad innesto rapido e selezione di fase.**  
*Continuous line LED lighting system for commercial and industrial areas.  
 Passing power line 7x1,5 mm<sup>2</sup> with quick connectors and phase selection.*



**A RICHIESTA | ON REQUEST**



<b>5Y WARRANTY</b> 5% FAILURE RATE	<b>60.000 h</b> LED LIFETIME L90B10	<b>100.000 h</b> LED LIFETIME L70B50
---------------------------------------	--	---

Relamping	Lumen LED*	Watt LED**	Lumen OUT***	Watt	Lumen Watt OUT	L Lunghezza L Length	Accensioni/Configurazione LED LED switching on/configuration	Codice Code	K	Alimentazione Power Supply	Colore Colour
2x58	<b>8200</b>	40	6480	44	> 147	1500 mm	==	<b>BDS249PS</b>	N: 4.000	- : CAE A RICHIESTA   ON REQUEST DL: DALI PD: PUSH DIM	01: bianco white
2x72	<b>10540</b>	54	8352	58	> 144	1500 mm	==	<b>BDS258PS</b>			
2x80	<b>11500</b>	64	9050	68	> 133	1500 mm	==	<b>BDS264PS</b>			
2+2x58	<b>16400</b>	80	12960	88	> 147	3000 mm	==	<b>BDS298PS</b>	N: 4.000	- : CAE A RICHIESTA   ON REQUEST DL: DALI PD: PUSH DIM	01: bianco white
2+2x72	<b>21680</b>	108	16700	116	> 144	3000 mm	==	<b>BDS2116PS</b>			
2+2x80	<b>23000</b>	128	18100	136	> 133	3000 mm	==	<b>BDS2128PS</b>			
2x58	<b>8200</b>	40	6480	44	> 147	1500 mm	==	<b>BDS2249PS</b>	N: 4.000	- : CAE A RICHIESTA   ON REQUEST DL: DALI PD: PUSH DIM	01: bianco white
2x72	<b>10540</b>	54	8352	58	> 144	1500 mm	==	<b>BDS2258PS</b>			
2x80	<b>11500</b>	64	9050	68	> 133	1500 mm	==	<b>BDS2264PS</b>			





Relamping	Lumen LED*	Watt LED**	Lumen OUT***	Watt	Lumen Watt OUT	L Lunghezza L Length	Accensioni/Configurazione LED LED switching on/configuration	Codice Code	K	Alimentazione Power Supply	Colore Colour
2+2x58	<b>16400</b>	80	12960	88	> 147	3000 mm		<b>BDS2498PS</b>	N: 4.000	— : CAE A RICHIESTA   ON REQUEST DL: DALI PD: PUSH DIM	01: bianco white
2+2x72	<b>21680</b>	108	16700	116	> 144	3000 mm		<b>BDS24116PS</b>			
2+2x80	<b>23000</b>	128	18100	136	> 133	3000 mm		<b>BDS24128PS</b>			

		<b>&gt;80</b> CRI	<b>IP50</b> EN 60529	<b>230 V</b> 2014/35/UE	<b>50/60</b> Hz	<b>IK 07</b> EN 60068
<b>850°</b> EN 60695		<b>RG 0</b> EN 62471		<b>01</b> WHITE	<b>19</b> UGR	

**05**  
SILVER

A richiesta | On request

TEMPERATURA AMBIENTE MIN E MAX | MIN AND MAX ROOM TEMPERATURE: **(-10° +40°)**

\* Lumen nominali LED max a 25° | Nominal lumen at max 25°

\*\* Potenza dei LED | LED power

\*\*\* Flusso totale in uscita dall'apparecchio a temperatura di lavoro (Ta 25° - 4.000 K) | Total lighting fitting flux output at working temperature (Ta 25° - 4.000 K) | (3.000 K -8% - CRI 90 -10%)

Schemi di accensione e collegamenti | Switching on and connection scheme: **(pp. 206)**

Accensione 1 | Switching on 1  
 Accensione 2 | Switching on 2

**A RICHIESTA / ON REQUEST**

- A richiesta sono disponibili apparecchi con diverse tipologie di accensione (per maggiori informazioni contattare il ns Ufficio Tecnico) | Fixtures with different switching on are available on request (for more details contact our Technical Department)



Accessori | Accessories  
p. 196-199



Descrizione prodotto | Product description  
p. 178



Schema di cablaggio | Connection scheme  
p. XXVIII-XXIX



Fotometrie | Photometries  
p. 179

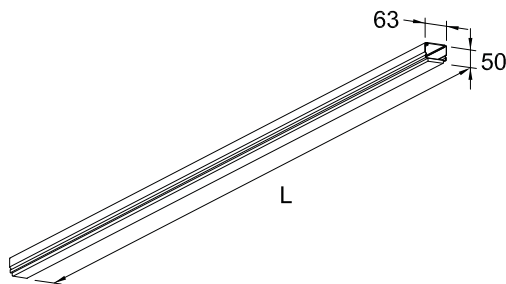

# BINLENS SYSTEM EX

## DIFFONDEnte/WIDE BEAM

Sistema fila continua a LED per l'illuminazione di aree commerciali ed industriali.

**Linea di alimentazione passante 7x1,5mm<sup>2</sup> con spinotti ad innesto rapido.**

*Continuous line LED lighting system for commercial and industrial areas.*

**Passing power line 7x1,5 mm<sup>2</sup> with quick connectors and phase selection.**



A RICHIESTA | ON REQUEST

<b>5Y WARRANTY</b> 5% FAILURE RATE	<b>60.000 h</b> LED LIFETIME L90B10	<b>100.000 h</b> LED LIFETIME L70B50
---------------------------------------	--	---

<b>&gt;90</b> CRI	<b>EM</b> EN 60910-2-22	<b>DL</b> DALI	<b>PD</b> PUSH DIM
----------------------	----------------------------	-------------------	-----------------------

Relamping	Lumen LED*	Watt LED**	Lumen Out***	Watt	Lumen Watt OUT	L Lunghezza L Length	Configurazione LED LED configuration	Codice Code	K	Alimentazione Power Supply	Lenti Lens
2x28	<b>4240</b>	22	3730	23,5	> 158	1122 mm	—	<b>BLS11</b>		— : CAE	
2x36	<b>5840</b>	31,5	5159	34	> 151	1122 mm	—	<b>BLS12</b>	W: 3.000 N: 4.000 C: 6.000	A RICHIESTA   ON REQUEST DL: DALI PD: PUSH DIM	<b>EX</b>
2x58	<b>8200</b>	47	7200	50	> 144	1122 mm	—	<b>BLS13</b>			
1x72	<b>5300</b>	27,5	4650	29,5	> 158	1403 mm	—	<b>BLS21</b>		— : CAE	
2x54	<b>7300</b>	39,5	6417	42,5	> 151	1403 mm	—	<b>BLS22</b>	W: 3.000 N: 4.000 C: 6.000	A RICHIESTA   ON REQUEST DL: DALI PD: PUSH DIM	<b>EX</b>
2x72	<b>10250</b>	58,5	9010	62,5	> 144	1403 mm	—	<b>BLS23</b>			
2x49	<b>6360</b>	33	5609	35,5	> 158	1683 mm	—	<b>BLS31</b>		— : CAE	
2x54	<b>8760</b>	47,5	7700	51	> 151	1683 mm	—	<b>BLS32</b>	W: 3.000 N: 4.000 C: 6.000	A RICHIESTA   ON REQUEST DL: DALI PD: PUSH DIM	<b>EX</b>
2x80	<b>12300</b>	70	10800	75	> 144	1683 mm	—	<b>BLS33</b>			
1+1x72	<b>10600</b>	55	9320	59	> 158	2805 mm	—	<b>BLS41</b>		— : CAE	
2+2x54	<b>14600</b>	79	12835	85	> 151	2805 mm	—	<b>BLS42</b>	W: 3.000 N: 4.000 C: 6.000	A RICHIESTA   ON REQUEST DL: DALI PD: PUSH DIM	<b>EX</b>
2+2x80	<b>20500</b>	117	18000	125	> 144	2805 mm	—	<b>BLS43</b>			

<b>CE</b>	<b>&gt;80</b> CRI	<b>IP50</b> EN 60529	<b>230 V</b> 2014/35/UE	<b>50/60</b> Hz	<b>IK 07</b> EN 60068
<b>850°</b> EN 60695	<b>RG0</b> EN 62471	<b>01</b> WHITE	<b>&gt;0.9</b> COS φ		

TEMPERATURA AMBIENTE MIN E MAX | MIN AND MAX ROOM TEMPERATURE: **(-10° +40°)**

\* Lumen nominali LED max a 25° | Nominal lumen at max 25°

\*\* Potenza dei LED | LED power

\*\*\* Flusso totale in uscita dall'apparecchio a temperatura di lavoro (Ta 25° - 4.000 K) | Total lighting fitting flux output at working temperature (Ta 25° - 4.000 K) | (3.000 K -8% - CRI 90 -10%)



Fotometrie | Photometries  
p. 181



Schema di cablaggio | Connection scheme  
p. XXVIII-XXIX



Descrizione prodotto | Product description  
p. 180



Accessori | Accessories  
p. 196-199



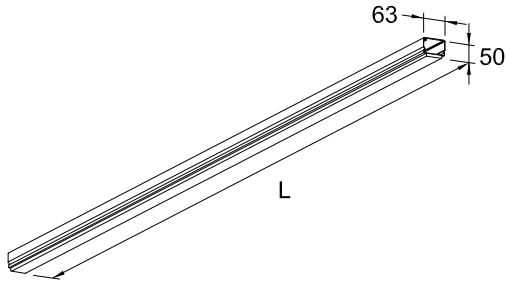

# BINLENS SYSTEM ST

## CONCENTRANTE/NARROW BEAM

Sistema fila continua a LED per l'illuminazione di aree commerciali ed industriali.  
**Linea di alimentazione passante 7x1,5mm<sup>2</sup> con spinotti ad innesto rapido.**

*Continuous line LED lighting system for commercial and industrial areas.*

**Passing power line 7x1,5 mm<sup>2</sup> with quick connectors and phase selection.**



**A RICHIESTA | ON REQUEST**



**5Y WARRANTY**  
5% FAILURE RATE

**60.000 h**  
LED LIFETIME L90B10

**100.000 h**  
LED LIFETIME L70B50

Relamping	Lumen LED*	Watt LED**	Lumen Out***	Watt	Lumen Watt OUT	L Lunghezza L Length	Configurazione LED LED configuration	Codice Code	K	Alimentazione Power Supply	Lenti Lens
2x28	<b>4240</b>	22	3730	23,5	> 158	1122 mm	—	<b>BLS11</b>	W: 3.000	— : CAE	<b>ST</b>
2x36	<b>5840</b>	31,5	5159	34	> 151	1122 mm	—	<b>BLS12</b>	N: 4.000 C: 6.000	A RICHIESTA   ON REQUEST DL: DALI	
2x58	<b>8200</b>	47	7200	50	> 144	1122 mm	—	<b>BLS13</b>	PD: PUSH DIM		
1x72	<b>5300</b>	27,5	4650	29,5	> 158	1403 mm	—	<b>BLS21</b>	W: 3.000	— : CAE	<b>ST</b>
2x54	<b>7300</b>	39,5	6417	42,5	> 151	1403 mm	—	<b>BLS22</b>	N: 4.000 C: 6.000	A RICHIESTA   ON REQUEST DL: DALI	
2x72	<b>10250</b>	58,5	9010	62,5	> 144	1403 mm	—	<b>BLS23</b>	PD: PUSH DIM		
2x49	<b>6360</b>	33	5609	35,5	> 158	1683 mm	—	<b>BLS31</b>	W: 3.000	— : CAE	<b>ST</b>
2x54	<b>8760</b>	47,5	7700	51	> 151	1683 mm	—	<b>BLS32</b>	N: 4.000 C: 6.000	A RICHIESTA   ON REQUEST DL: DALI	
2x80	<b>12300</b>	70	10800	75	> 144	1683 mm	—	<b>BLS33</b>	PD: PUSH DIM		
1+1x72	<b>10600</b>	55	9320	59	> 158	2805 mm	—	<b>BLS41</b>	W: 3.000	— : CAE	<b>ST</b>
2+2x54	<b>14600</b>	79	12835	85	> 151	2805 mm	—	<b>BLS42</b>	N: 4.000 C: 6.000	A RICHIESTA   ON REQUEST DL: DALI	
2+2x80	<b>20500</b>	117	18000	125	> 144	2805 mm	—	<b>BLS43</b>	PD: PUSH DIM		

		<b>&gt;80</b> CRI	<b>IP50</b> EN 60529	<b>230 V</b> 2014/35/UE	<b>50/60</b> Hz	<b>IK 07</b> EN 60068
<b>850°</b> EN 60695		<b>RG 0</b> EN 62471		<b>01</b> WHITE	<b>&gt;0.9</b> COS φ	<b>19</b> UGR

TEMPERATURA AMBIENTE MIN E MAX | MIN AND MAX ROOM TEMPERATURE: **(-10° +40°)**

\* Lumen nominali LED max a 25° | Nominal lumen at max 25°

\*\* Potenza dei LED | LED power

\*\*\* Flusso totale in uscita dall'apparecchio a temperatura di lavoro (Ta 25° - 4.000 K) | Total lighting fitting flux output at working temperature (Ta 25° - 4.000 K) | (3.000 K -8% - CRI 90 -10%)



Accessori | Accessories  
p. 196-199



Descrizione prodotto | Product description  
p. 180



Schema di cablaggio | Connection scheme  
p. XXVIII-XXIX



Fotometrie | Photometries  
p. 181

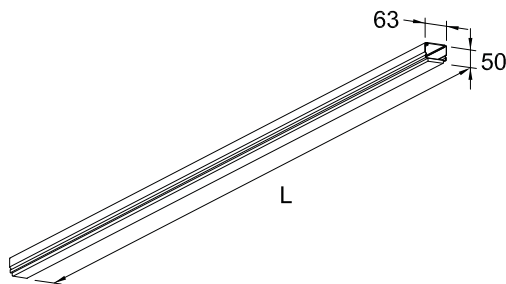

# BINLENS SYSTEM BT

## BATWING

Sistema fila continua a LED per l'illuminazione di aree commerciali ed industriali.

**Linea di alimentazione passante 7x1,5mm<sup>2</sup> con spinotti ad innesto rapido.**

*Continuous line LED lighting system for commercial and industrial areas.*

**Passing power line 7x1,5 mm<sup>2</sup> with quick connectors and phase selection.**



**A RICHIESTA | ON REQUEST**

<b>5Y WARRANTY</b> 5% FAILURE RATE	<b>60.000 h</b> LED LIFETIME L90B10	<b>100.000 h</b> LED LIFETIME L70B50
---------------------------------------	--	---

<b>&gt;90</b> CRI	<b>EM</b> EN 60910-2-22	<b>DL</b> DALI	<b>PD</b> PUSH DIM
----------------------	----------------------------	-------------------	-----------------------

Relamping	Lumen LED*	Watt LED**	Lumen Out***	Watt	Lumen Watt OUT	L Lunghezza L Length	Configurazione LED LED configuration	Codice Code	K	Alimentazione Power Supply	Lenti Lens
2x28	<b>4240</b>	22	3730	23,5	> 158	1122 mm	—	<b>BLS11</b>	W: 3.000	— : CAE	<b>BT</b>
2x36	<b>5840</b>	31,5	5159	34	> 151	1122 mm	—	<b>BLS12</b>	N: 4.000 A RICHIESTA   ON REQUEST		
2x58	<b>8200</b>	47	7200	50	> 144	1122 mm	—	<b>BLS13</b>	C: 6.000 DL: DALI PD: PUSH DIM		
1x72	<b>5300</b>	27,5	4650	29,5	> 158	1403 mm	—	<b>BLS21</b>	W: 3.000	— : CAE	<b>BT</b>
2x54	<b>7300</b>	39,5	6417	42,5	> 151	1403 mm	—	<b>BLS22</b>	N: 4.000 A RICHIESTA   ON REQUEST		
2x72	<b>10250</b>	58,5	9010	62,5	> 144	1403 mm	—	<b>BLS23</b>	C: 6.000 DL: DALI PD: PUSH DIM		
2x49	<b>6360</b>	33	5609	35,5	> 158	1683 mm	—	<b>BLS31</b>	W: 3.000	— : CAE	<b>BT</b>
2x54	<b>8760</b>	47,5	7700	51	> 151	1683 mm	—	<b>BLS32</b>	N: 4.000 A RICHIESTA   ON REQUEST		
2x80	<b>12300</b>	70	10800	75	> 144	1683 mm	—	<b>BLS33</b>	C: 6.000 DL: DALI PD: PUSH DIM		
1+1x72	<b>10600</b>	55	9320	59	> 158	2805 mm	—	<b>BLS41</b>	W: 3.000	— : CAE	<b>BT</b>
2+2x54	<b>14600</b>	79	12835	85	> 151	2805 mm	—	<b>BLS42</b>	N: 4.000 A RICHIESTA   ON REQUEST		
2+2x80	<b>20500</b>	117	18000	125	> 144	2805 mm	—	<b>BLS43</b>	C: 6.000 DL: DALI PD: PUSH DIM		

<b>CE</b>	<b>&gt;80</b> CRI	<b>IP50</b> EN 60529	<b>230 V</b> 2014/35/UE	<b>50/60</b> Hz	<b>IK 07</b> EN 60668
<b>850°</b> EN 60695	<b>RG 0</b> EN 62471	<b>01</b> WHITE	<b>&gt;0.9</b> COS φ	<b>19</b> UGR	

TEMPERATURA AMBIENTE MIN E MAX | MIN AND MAX ROOM TEMPERATURE: (-10° +40°)

\* Lumen nominali LED max a 25° | Nominal lumen at max 25°

\*\* Potenza dei LED | LED power

\*\*\* Flusso totale in uscita dall'apparecchio a temperatura di lavoro (Ta 25° - 4.000 K) | Total lighting fitting flux output at working temperature (Ta 25° - 4.000 K) | (3.000 K -8% - CRI 90 -10%)



**SUPERMERCATO** | FRANCIA  
**MARKET** | FRANCE



**SUPERMERCATO IPER** | ITALIA  
**MARKET IPER** | ITALY



**SUPERMERCATO IPER** | ITALIA  
**MARKET IPER** | ITALY



**SUPERMERCATO IPER** | ITALIA  
**MARKET IPER** | ITALY



**INSEGNA**  
**SIGNBOARD**



**SUPERMERCATO** | FRANCIA  
**MARKET** | FRANCE

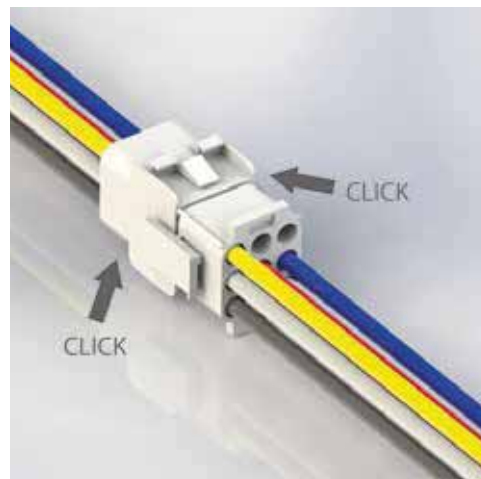
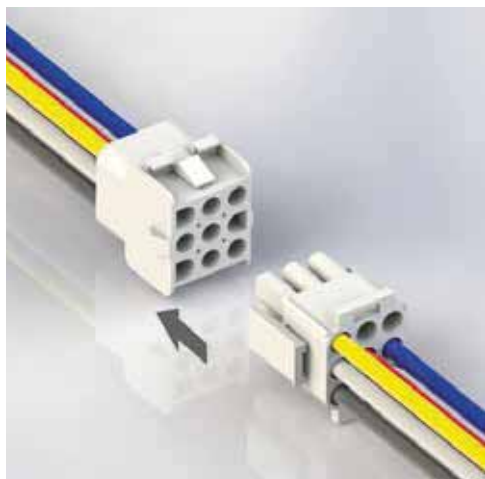

**CABLAGGIO STANDARD MONOFASE - STANDARD MONO-PHASE POWER SUPPLY**

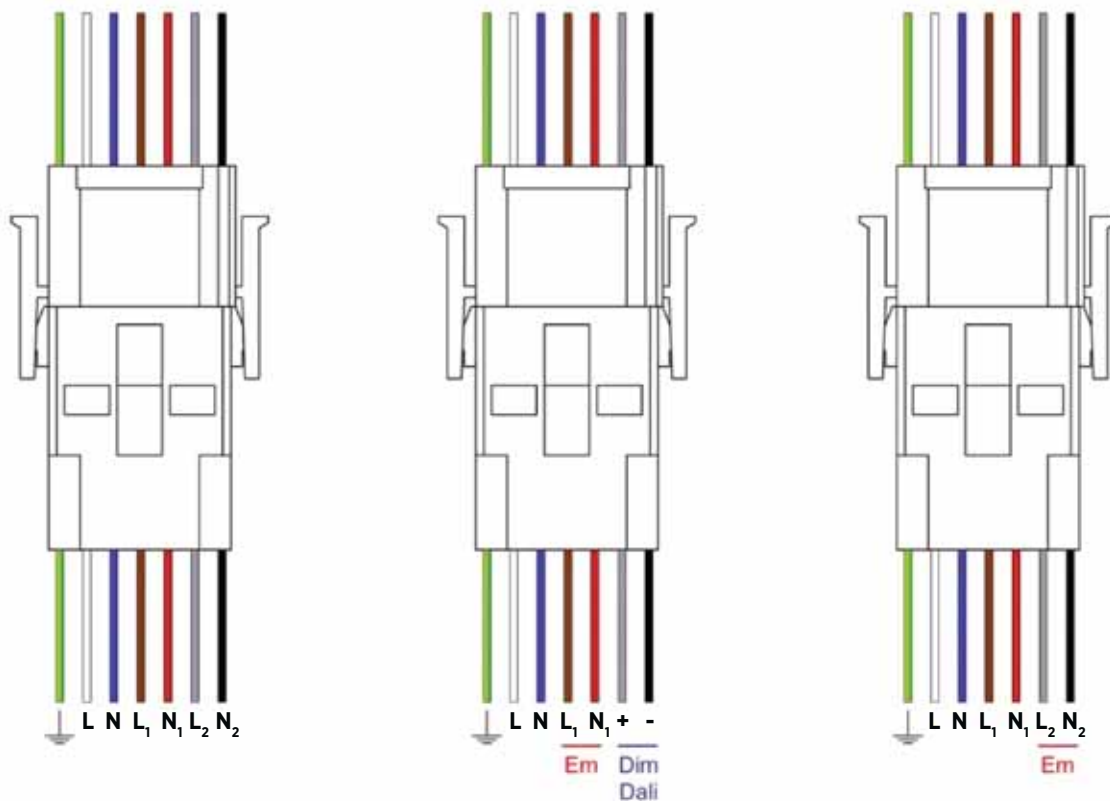

**PROLUNGABILITÀ MAX:**

- 22,5 m con alimentazione monofase, caduta di tensione 1% a 40°C
- 67,5 m con alimentatore trifase, caduta di tensione 1,5% a 40°C

**CONTINUOUS LINE UP TO:**

- 22,5 m with mono-phase power supply 1% voltage drop at 40°C
- 67,5 m with three-phase power supply 1,5% voltage drop at 40°C

N.B. La scelta di fase d'alimentazione e della protezione dell'impianto deve essere coordinata con il numero di apparecchi installati.  
*Pls note: choice of phase feeding and plant protection must be coordinated with the number of the installed LED fittings.*

**Schemi di accensione e collegamenti | Switching on and connection**

- Accensione 1 | Switching on 1
- Accensione 2 | Switching on 2

## **A RICHIESTA CABLAGGIO TRIFASE - *ON REQUEST* THREE-PHASE POWER SUPPLY**

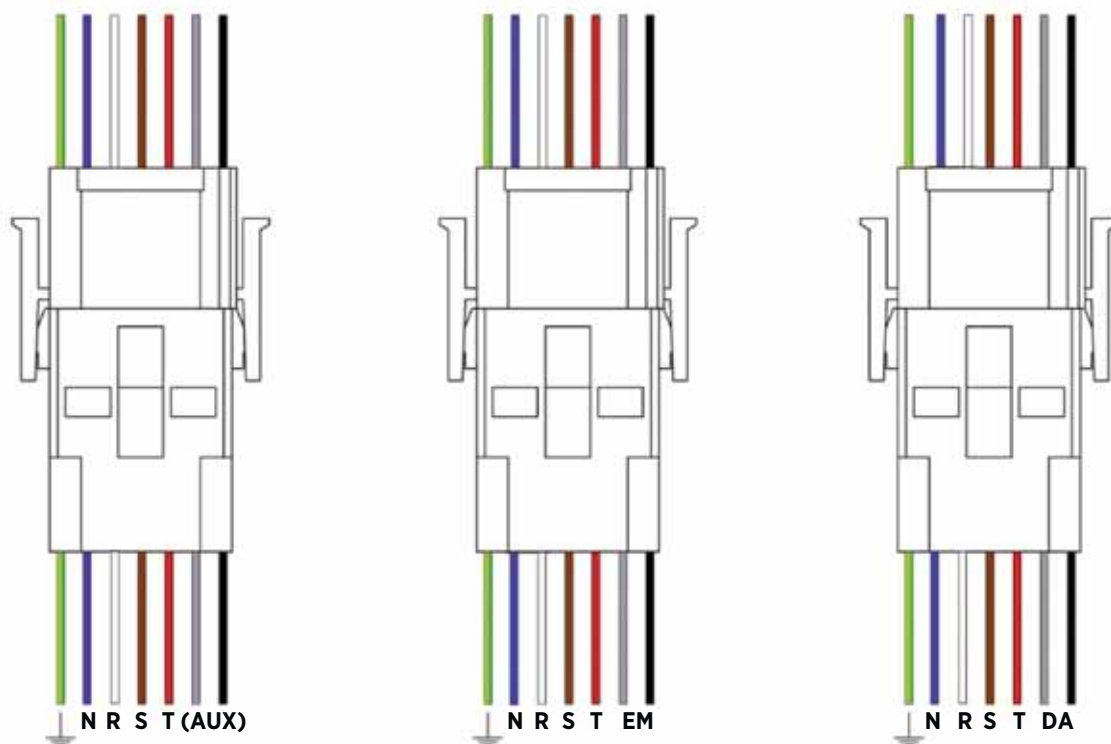

### **BINGO SYSTEM LED BINGO SYSTEM LED PLUS BINLENS SYSTEM**

Barre in acciaio zincato a caldo e verniciate a base poliestere in colore grigio o bianco, ottenute tramite rolling process. Resistenza alla nebbia salina pari a 300h e all' umido stato pari a 700h. Coperchio di chiusura in policarbonato. Linea di alimentazione in cascata a 7 poli N07V-K, di sez. 1,5 mm<sup>2</sup> con presa/spina all'estremità, a innesto rapido e ganci di sicurezza. Diramazioni a più vie, con presa a innesto rapido a 2 poli per il collegamento elettrico degli elementi ausiliari a selezione di fase. Barre cablate con possibilità di selezione di accensione. Per tutte le versioni, conformità alle norme IEC 60598-1 e CEI EN 60598-1.

### **BINGO SYSTEM LED BINGO SYSTEM LED PLUS BINLENS SYSTEM**

*Hot galvanized steel bars painted in gray or white polyester base, obtained through rolling process. Sea mist resistance equal to 300h and wet resistance equal to 700h. Polycarbonate end cover. 7 poles N07V-K feeding line, sec. 1,5 mm<sup>2</sup> with plug/connector at the end, quick-release and safety clips. Multi-way branches, with 2-pole fast-coupling terminal block for the electrical connection of the auxiliary elements. Line wired bars with the possibility to select different switching on. All versions comply with IEC 60598-1 and IEC 60598-1.*



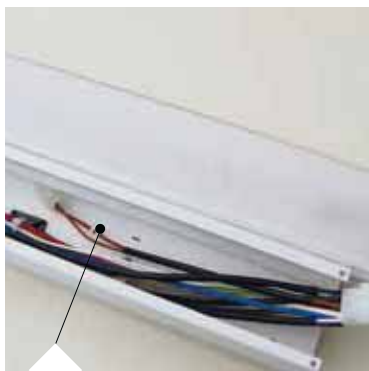

Particolare linea passante 7x1,5 mm<sup>2</sup>  
E spinotto di selezione di fase.  
*Detail of the passing power line  
7X1,5 mm<sup>2</sup> and selection phase pin.*



Particolare della copertura anti polvere.  
*Detail of the anti dust cover.*



Particolare spinotto selezione di fase.  
*Detail of the selection phase pin.*

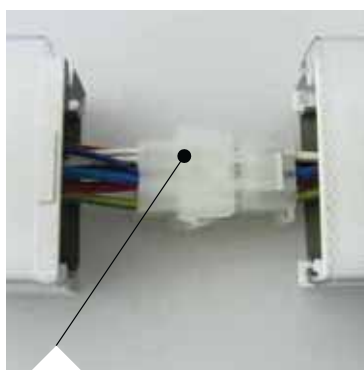

Particolare del sistema di connessione.  
*Detail of the connection system.*



Particolare linea passante 7X1,5 mm<sup>2</sup>.  
*Detail of the passing power line 7x1,5  
mm<sup>2</sup>.*

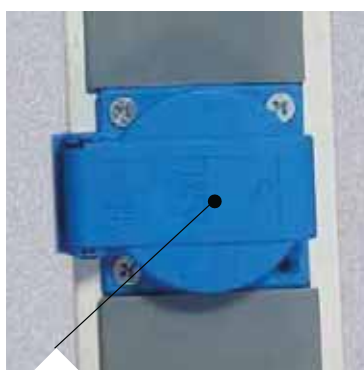

Presca ausiliaria derivazione forza motrice.  
*Auxiliary plug for power supply.*













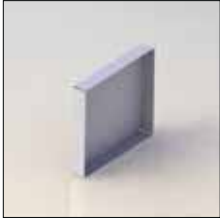
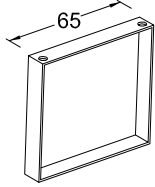

## **BDS-KS**

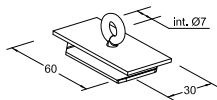
Scorrimento sistema di fissaggio su tutta la lunghezza del prodotto per facilitare il relamping utilizzando i fissaggi esistenti.

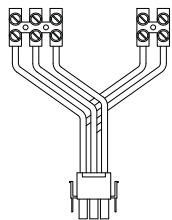
*Power cable with fixing system slides along all back of the body for easy replacement of existing fixings.*

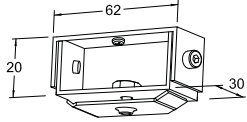

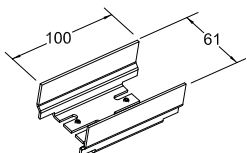
		DESCRIZIONE ACCESSORIO <i>ACCESSORY DESCRIPTION</i>	IDONEO PER: <i>SUITABLE FOR:</i>	CODICE <i>CODE</i>
		Testata di chiusura in acciaio. <i>Steel end cover.</i>	BINGO SYSTEM LED BINGO SYSTEM LED PLUS BINLENS SYSTEM	<b>BDS-F</b> Per   For Bingo System Led  <b>BDSAS-F</b> Per   For Bingo System Led Plus  <b>BLS-F</b> Per   For Binlens System
		Sistema di fissaggio per sospensione in acciaio zincato compreso top di chiusura (comprende 1 golfare, 1 piastra e 1 contropiastra).  <i>Suspension fixing kit made of zinc coated steel, including top cover (includes 1 eyebolt, 1 plate and 1 counter plate).</i>	BINGO LED BINGO SYSTEM LED BINGO SYSTEM LED PLUS BINLENS SYSTEM	<b>BDS-KS</b>
		Connettore di alimentazione. <i>Power connector.</i>	BINGO SYSTEM LED BINGO SYSTEM LED PLUS BINLENS SYSTEM	<b>BDS-A</b>
		Staffa di fissaggio a plafone. <i>Fixing bracket for ceiling mounted.</i>	BINGO LED BINGO SYSTEM LED BINGO SYSTEM LED PLUS BINLENS SYSTEM	<b>BDS-KSP</b>
		Giunto lineare a scomparsa. <i>Hidden linear joint.</i>	BINGO SYSTEM LED BINGO SYSTEM LED PLUS BINLENS SYSTEM	<b>BDS-G</b> Per   For Bingo System Led- Bingo System Led Plus  <b>BLS-G</b> Per   For Binlens System

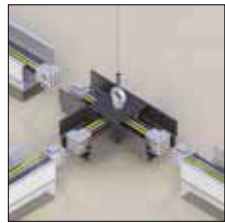
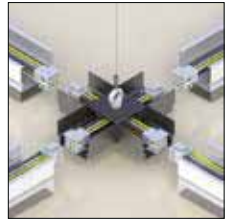
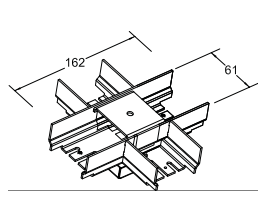
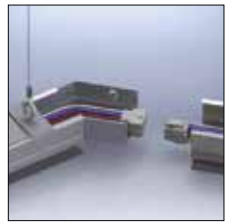
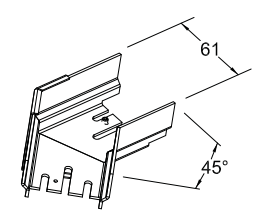
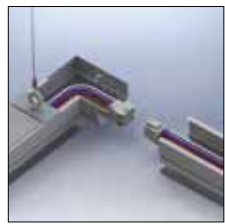
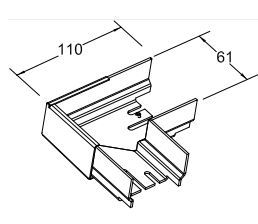
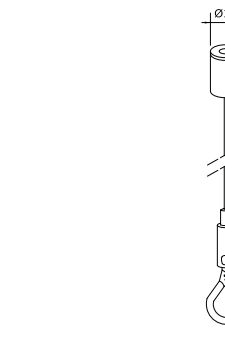
		DESCRIZIONE ACCESSORIO ACCESSORY DESCRIPTION	IDONEO PER: SUITABLE FOR:	CODICE CODE
		<p>Giunto a tre vie in acciaio zincato, compresi top di chiusura e cavi di alimentazione.</p> <p><i>Zinc coated steel T joint, including top cover and cables.</i></p>	<p>BINGO SYSTEM LED BINGO SYSTEM LED PLUS BINLENS SYSTEM</p>	<p><b>BDS-T</b> Per   For Bingo System Led- Bingo System Led Plus</p> <p><b>BLS-T</b> Per   For Binlens System</p>
		<p>Giunto a quattro vie in acciaio zincato, compresi top di chiusura e cavi di alimentazione.</p> <p><i>Zinc coated steel X joint, including top cover and cables.</i></p>	<p>BINGO SYSTEM LED BINGO SYSTEM LED PLUS BINLENS SYSTEM</p>	<p><b>BDS-C</b> Per   For Bingo System Led- Bingo System Led Plus</p> <p><b>BLS-C</b> Per   For Binlens System</p>
		<p>Giunto angolare 45° in acciaio zincato, compresi top di chiusura e cavi di alimentazione.</p> <p><i>Zinc coated steel 45° angular joint, including top cover and cables.</i></p>	<p>BINGO SYSTEM LED BINGO SYSTEM LED PLUS BINLENS SYSTEM</p>	<p><b>BDS-45</b> Per   For Bingo System Led- Bingo System Led Plus</p> <p><b>BLS-45</b> Per   For Binlens System</p>
		<p>Giunto angolare 90° in acciaio zincato, compresi top di chiusura e cavi di alimentazione.</p> <p><i>Zinc coated steel L 90° joint, including top cover and cables.</i></p>	<p>BINGO SYSTEM LED BINGO SYSTEM LED PLUS BINLENS SYSTEM</p>	<p><b>BDS</b> Per   For Bingo System Led- Bingo System Led Plus</p> <p><b>BLS</b> Per   For Binlens System</p>
		<p>Kit sospensione: <b>n. 1 cavo d'acciaio</b> L=2000 mm n. 1 morsetto automatico con regolazione millimetrica n. 2 rosone cilindrico</p> <p><i>Suspension kit: <b>no. 1 steel cables</b> L=2000 mm no. 1 precision adjustment automatic hook no. 2 cylindrical ceiling roses</i></p>	<p>BINGO BINGO SYSTEM LED BINLENS SYSTEM</p>	<p><b>KT10411</b></p>

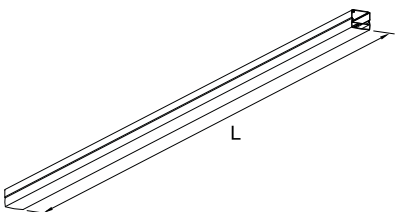
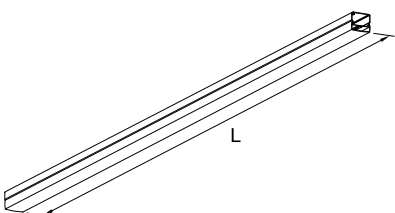
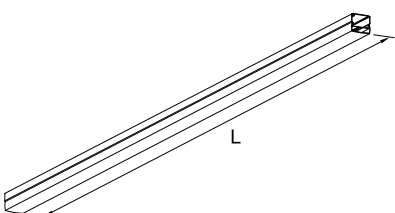
	DESCRIZIONE ACCESSORIO ACCESSORY DESCRIPTION	IDONEO PER: SUITABLE FOR:	CODICE CODE
	Canale cieco 1 m. <i>Blind channel 1 m.</i>	BINGO SYSTEM LED BINGO SYSTEM LED PLUS	<b>BDS-CK-1000</b> Per   For Bingo System Led  <b>BDS-PS-CK-1000</b> Per   For Bingo System Led Plus
	Canale cieco 1,5 m. <i>Blind channel 1,5 m.</i>	BINGO SYSTEM LED BINGO SYSTEM LED PLUS	<b>BDS-CK-1500</b> Per   For Bingo System Led  <b>BDS-PS-CK-1500</b> Per   For Bingo System Led Plus
	Canale cieco 2 m. <i>Blind channel 2 m.</i>	BINGO SYSTEM LED BINGO SYSTEM LED PLUS	<b>BDS-CK-2000</b> Per   For Bingo System Led  <b>BDS-PS-CK-2000</b> Per   For Bingo System Led Plus
	Canale cieco 2,5 m. <i>Blind channel 2,5 m.</i>	BINGO SYSTEM LED BINGO SYSTEM LED PLUS	<b>BDS-CK-2500</b> Per   For Bingo System Led  <b>BDS-PS-CK-2500</b> Per   For Bingo System Led Plus

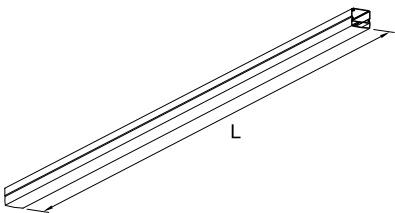
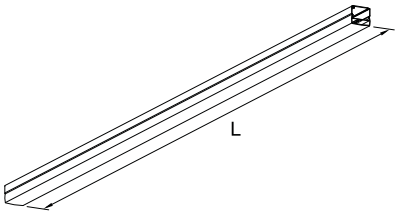
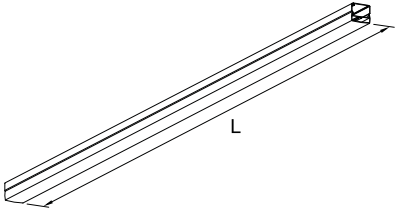
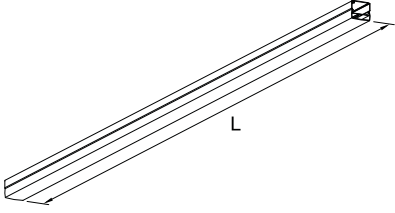
	DESCRIZIONE ACCESSORIO ACCESSORY DESCRIPTION	IDONEO PER: SUITABLE FOR:	CODICE CODE
	Canale cieco 1122 mm <i>Blind channel 1122 mm</i>	BINLENS SYSTEM	<b>BLS-CK-1122</b>
	Canale cieco 1403 mm <i>Blind channel 1403 mm</i>	BINLENS SYSTEM	<b>BLS-CK-1403</b>
	Canale cieco 1683 mm <i>Blind channel 1683 mm</i>	BINLENS SYSTEM	<b>BLS-CK-1683</b>
	Canale cieco 2805 mm <i>Blind channel 2805 mm</i>	BINLENS SYSTEM	<b>BLS-CK-2805</b>



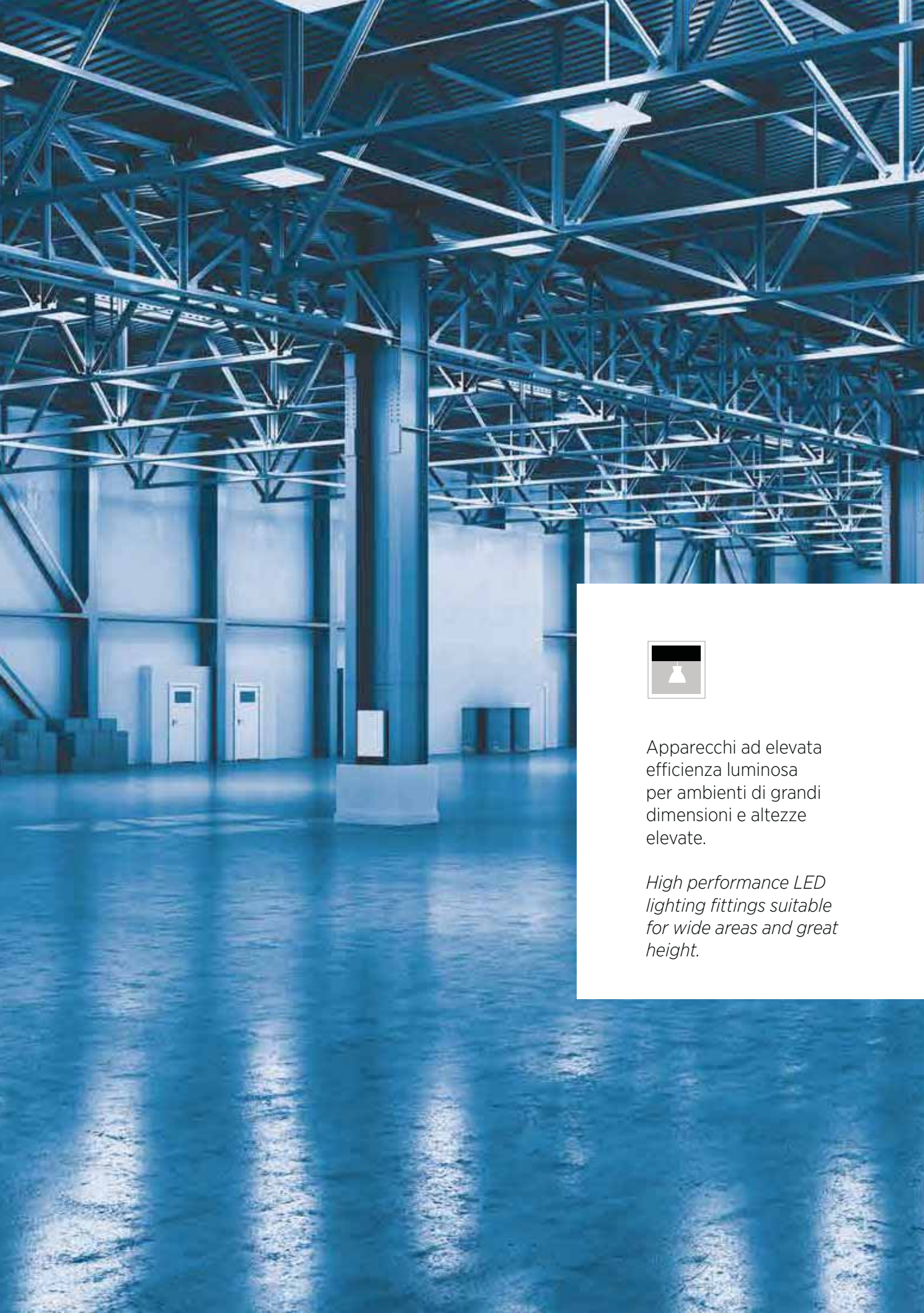

Apparecchi ad elevata  
efficienza luminosa  
per ambienti di grandi  
dimensioni e altezze  
elevate.

*High performance LED  
lighting fittings suitable  
for wide areas and great  
height.*





## **INDUSTRIALI E COMMERCIALI** INDUSTRIAL & COMMERCIAL

Apparecchi industriali a LED per l'illuminazione di aree commerciali ed industriali.  
*LED industrial fittings for lighting of commercial and industrial areas.*



# GAMMA PRODOTTI | PRODUCT RANGE

## INDUSTRIALI E COMMERCIALI INDUSTRIAL & COMMERCIAL



### AMBI U

p. 208

Corpo e telaio in lamiera d'acciaio pressopiegata, verniciata con polveri epossidiche previa fosfatazione. Vetro temperato trasparente, chiusura con viti in acciaio inox (a richiesta policarbonato microprismato UGR19). Riflettore in alluminio speculare diffondente U. Connettore ad innesto rapido compreso di presa femmina in testata. Sistema di fissaggio a sospensione. Sorgente luminosa LED. Emissione diretta. Non idonea per applicazioni esterne. Alimentazione elettronica CAE. A richiesta: dimmerabile DALI (cod. DL) specificare se con funzione PUSH DIM (cod. PD).

*Bent sheet steel body and frame painted with epoxy powders after phosphating. Tempered transparent glass fastened with stainless steel screws. On request: microprismatic polycarbonate diffuser UGR19. Aluminium specular wide beam reflector U. Quick plug-in connector complete with female socket on endcover. Suspension mounting system. LED light source. Direct light emission. Not suitable for outdoor application. Built-in electronic driver CAE. On request: dimmable DALI (code DL) PUSH DIM function (code PD) to be requested.*



### AMBI I

p. 209

Corpo e telaio in lamiera d'acciaio pressopiegata, verniciata con polveri epossidiche previa fosfatazione. Vetro temperato trasparente, chiusura con viti in acciaio inox (a richiesta policarbonato microprismato UGR19). Riflettore in alluminio speculare concentrante I. Sistema di fissaggio a sospensione. Sorgente luminosa LED. Emissione diretta. Connettore ad innesto rapido compreso di presa femmina in testata. Non idonea per applicazioni esterne. Alimentazione elettronica CAE. A richiesta: dimmerabile DALI (cod. DL) specificare se con funzione PUSH DIM (cod. PD).

*Bent sheet steel body and frame painted with epoxy powders after phosphating. Tempered transparent glass fastened with stainless steel screws. On request: microprismatic polycarbonate diffuser UGR19. Aluminium specular narrow beam reflector I. Quick plug-in connector complete with female socket on endcover. Suspension mounting system. LED light source. Direct light emission. Not suitable for outdoor application. Built-in electronic driver CAE. On request: dimmable DALI (code DL) PUSH DIM function (code PD) to be requested.*



### FUTURA

p. 210

Corpo e telaio in lamiera d'acciaio pressopiegata, verniciata con polveri epossidiche previa fosfatazione. Lastra microprismata in policarbonato ad alto rendimento fissata con viti in acciaio inox. Ottica ad alto rendimento in alluminio speculare. Sistema di fissaggio a sospensione, Morsettiere a innesto rapido con sportello ispezionabile. Sorgente luminosa LED. Emissione diretta. Non idonea per applicazione esterne. Alimentazione elettronica CAE. A richiesta: dimmerabile DALI (cod. DL) specificare se con funzione PUSH DIM (cod. PD).

*Bent sheet steel body and frame painted with epoxy powders after phosphating. High performance microprismatic diffuser fixed with stainless steel screws. High performance polished aluminium louver. Rapid connection terminal block with inspection door. Suspension mounting system. LED light source. Direct light emission. Not suitable for outdoor application. Built-in electronic driver CAE. On request: dimmable DALI (code DL) PUSH DIM function (code PD) to be requested.*



### FUTURA PLUS

p. 211

Corpo e telaio in lamiera d'acciaio pressopiegata, verniciata con polveri epossidiche previa fosfatazione. Lastra microprismata in policarbonato ad alto rendimento fissata con viti in acciaio inox. Ottica ad alto rendimento in alluminio speculare. Sorgente luminosa LED. Emissione diretta. Sistema di fissaggio a sospensione, Morsettiere a innesto rapido con sportello ispezionabile. Non idonea per applicazione esterne. Alimentazione elettronica CAE. A richiesta: dimmerabile DALI (cod. DL) specificare se con funzione PUSH DIM (cod. PD).

*Bent sheet steel body and frame painted with epoxy powders after phosphating. High performance microprismatic diffuser fixed with stainless steel screws. High performance polished aluminium louver. Rapid connection terminal block with inspection door. Suspension mounting system. LED light source. Direct light emission. Not suitable for outdoor application. Built-in electronic driver CAE. On request: dimmable DALI (code DL) PUSH DIM function (code PD) to be requested.*



### FUTURA SMALL

p. 212

Corpo e telaio in lamiera d'acciaio pressopiegata, verniciata con polveri epossidiche previa fosfatazione. Lastra microprismata in policarbonato ad alto rendimento fissata con viti in acciaio inox. Ottica ad alto rendimento in alluminio speculare. Sistema di fissaggio a sospensione, Morsettiere a innesto rapido con sportello ispezionabile. Sorgente luminosa LED. Emissione diretta. Non idonea per applicazione esterne. Alimentazione elettronica CAE. A richiesta: dimmerabile DALI (cod. DL) specificare se con funzione PUSH DIM (cod. PD).

*Bent sheet steel body and frame painted with epoxy powders after phosphating. High performance microprismatic diffuser fixed with stainless steel screws. High performance polished aluminium louver. Rapid connection terminal block with inspection door. Suspension mounting system. LED light source. Direct light emission. Not suitable for outdoor application. Built-in electronic driver CAE. On request: dimmable DALI (code DL) PUSH DIM function (code PD) to be requested.*

# FOTOMETRIE | PHOTOMETRIES

INDUSTRIALI E COMMERCIALI  
INDUSTRIAL & COMMERCIAL

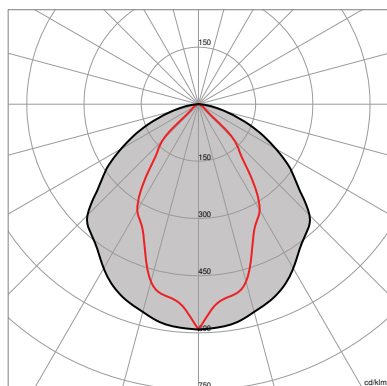

AMBI U

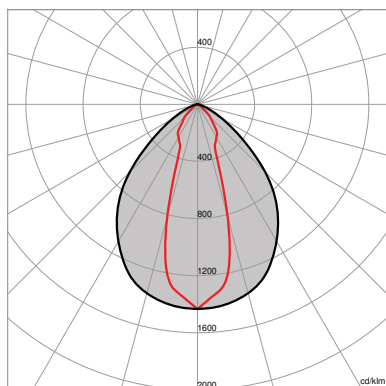

AMBI I

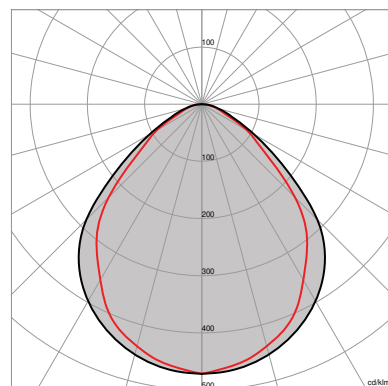

FUTURA

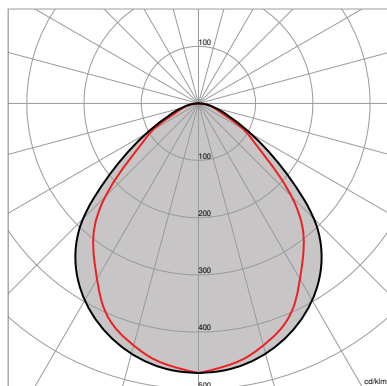

FUTURA PLUS

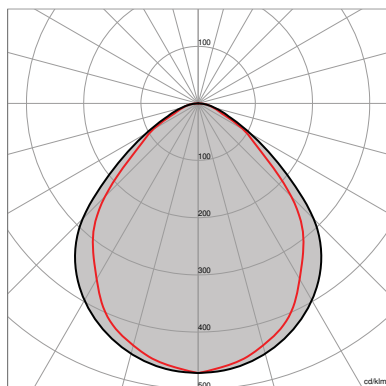

FUTURA SMALL



Rimani aggiornato  
Keep up to date



# GAMMA PRODOTTI | PRODUCT RANGE

## INDUSTRIALI E COMMERCIALI INDUSTRIAL & COMMERCIAL

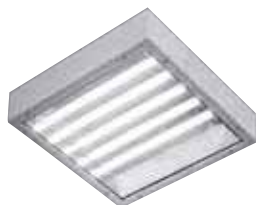

### FUTURA IP55D

p. 214

Corpo e telaio in lamiera d'acciaio pressopiegata, verniciata con polveri epossidiche previa fosfatazione. Vetro temperato trasparente antishock termico, chiusura con viti in acciaio inox. Ottica ad alto rendimento in alluminio speculare. Sistema di fissaggio a sospensione, Morsettiere a innesto rapido con sportello ispezionabile. Sorgente luminosa LED. Emissione diretta. Non idonea per applicazione esterne. Alimentazione elettronica CAE. A richiesta: dimmerabile DALI (cod. DL) specificare se con funzione PUSH DIM (cod. PD).

*Bent sheet steel body and frame painted with epoxy powders after phosphating. Tempered transparent glass fastened with stainless steel screws. High performance polished specular aluminium louver. Rapid connection terminal block with inspection door. Suspension mounting system. LED light source. Direct light emission. Not suitable for outdoor application. Built-in electronic driver CAE. On request: dimmable DALI (code DL) PUSH DIM function (code PD) to be requested.*



### DUNDI LED

p. 216

Corpo in lamiera d'alluminio tornito in lastra, verniciata con polveri epossidiche previa fosfatazione. Vetro temperato trasparente antishock termico, fissato tramite anello in lamiera zincata con maniglia di apertura e blocco di sicurezza. Guarnizione in silicone. Pressacavo completo di cavo uscente. Riflettore in alluminio tornito 99,85%, ossidato e brillatato anodicamente per un elevato rendimento luminoso. Sistema di fissaggio a sospensione con gancio in acciaio zincato. Sorgente luminosa LED. Emissione diretta. Non idonea per applicazioni all'esterno. Alimentazione elettronica CAE. A richiesta: DALI (dimmerabile DALI).

*Spun sheet aluminium body painted with epoxy powders after phosphating. Tempered transparent thermal anti-shock glass. Galvanized plate fixing ring with opening handle and safety lock. Silicon gasket. Cable gland complete with outgoing cable. Spun aluminium reflector 99,85% oxidized, anodized and polished for a high luminous efficiency. Suspension mounting system with galvanized steel hook. LED light source. Direct light emission. Not suitable for outdoor application. Built-in electronic driver CAE. On request: dimmable DALI (code DL).*



### DN LED

p. 217

Corpo in lamiera d'alluminio tornito in lastra, verniciata con polveri epossidiche previa fosfatazione. Vetro temperato trasparente antishock termico, fissato tramite anello in lamiera zincata con maniglia di apertura e blocco di sicurezza. Guarnizione in silicone. Dissipatore: alluminio estruso ed anodizzato. Pressacavo completo di cavo uscente. Riflettore in alluminio tornito 99,85%, ossidato e brillatato anodicamente per un elevato rendimento luminoso. Sistema di fissaggio a sospensione con gancio in acciaio zincato. Sorgente luminosa LED. Emissione diretta. Non idonea per applicazioni all'esterno. Alimentazione elettronica CAE. A richiesta: DALI (dimmerabile DALI).

*Spun sheet aluminium body painted with epoxy powders after phosphating. Tempered transparent thermal anti-shock glass. Galvanized plate fixing ring with opening handle and safety lock. Silicon gasket. Extruded and anodized aluminium heatsink. Cable gland complete with outgoing cable. Spun aluminium reflector 99,85% oxidized, anodized and polished for a high luminous efficiency. Suspension mounting system with galvanized steel hook. LED light source. Direct light emission. Not suitable for outdoor application. Built-in electronic driver CAE. On request: dimmable DALI (code DL).*



### ESSENTIAL COB

p. 218

Corpo in lamiera d'acciaio pressopiegata verniciata con polveri epossidiche previa fosfatazione. Vetro temperato trasparente anti-shock termico fissato tramite anello in lamiera zincata con maniglia di apertura e blocco di sicurezza. Guarnizione in silicone. Dissipatore in alluminio estruso e anodizzato. Connettore ad innesto rapido compreso di presa femmina in testata. Riflettore in alluminio tornito 99,85% ossidato e brillatato anodicamente per un elevato rendimento luminoso. Sistema di fissaggio a sospensione con gancio in acciaio zincato. Sorgente luminosa LED. Emissione diretta. Non idonea per applicazioni all'esterno. Alimentazione elettronica CAE. A richiesta: DL (dimmerabile DALI).

*Bent sheet steel aluminium body painted with epoxy powders after phosphating. Tempered transparent thermal anti-shock glass. Galvanized plate fixing ring with opening handle and safety lock. Silicon gasket. Extruded and anodized aluminium heatsink. Quick plug-in connector with female socket on endcover. Spun aluminium reflector 99,85% oxidized, anodized and polished for a high luminous efficiency. Suspension mounting system with galvanized steel hook. LED light source. Direct light emission. Not suitable for outdoor application. Built-in electronic driver CAE. On request: dimmable DALI (code DL).*



### ESSENTIAL

p. 219

Corpo in lamiera d'acciaio pressopiegata verniciata con polveri epossidiche previa fosfatazione. Vetro temperato trasparente anti-shock termico fissato tramite anello in lamiera zincata con maniglia di apertura e blocco di sicurezza. Guarnizione in silicone. Dissipatore in alluminio estruso e anodizzato. Connettore ad innesto rapido compreso di presa femmina in testata. Riflettore in alluminio tornito 99,85% ossidato e brillatato anodicamente per un elevato rendimento luminoso. Sistema di fissaggio a sospensione con gancio in acciaio zincato. Sorgente luminosa LED. Emissione diretta. Non idonea per applicazioni all'esterno. Alimentazione elettronica CAE. A richiesta: DL (dimmerabile DALI).

*Bent sheet steel aluminium body painted with epoxy powders after phosphating. Tempered transparent thermal anti-shock glass. Galvanized plate fixing ring with opening handle and safety lock. Silicon gasket. Extruded and anodized aluminium heatsink. Quick plug-in connector with female socket on endcover. Spun aluminium reflector 99,85% oxidized, anodized and polished for a high luminous efficiency. Suspension mounting system with galvanized steel hook. LED light source. Direct light emission. Not suitable for outdoor application. Built-in electronic driver CAE. On request: dimmable DALI (code DL).*

# FOTOMETRIE | PHOTOMETRIES

INDUSTRIALI E COMMERCIALI  
INDUSTRIAL & COMMERCIAL

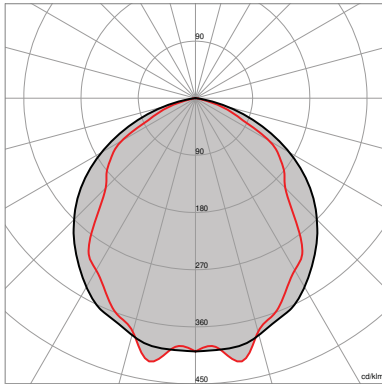

FUTURA IP55

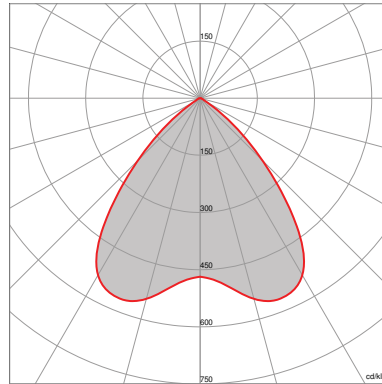

DUNDI LED

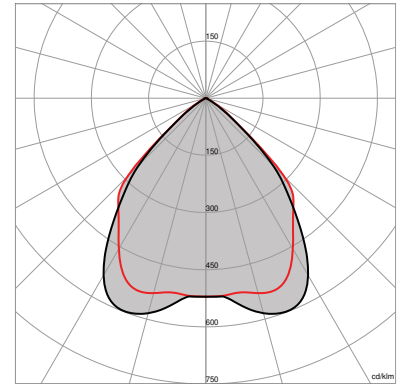

DN LED

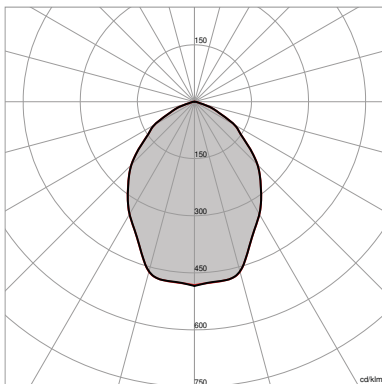

ESSENTIAL COB

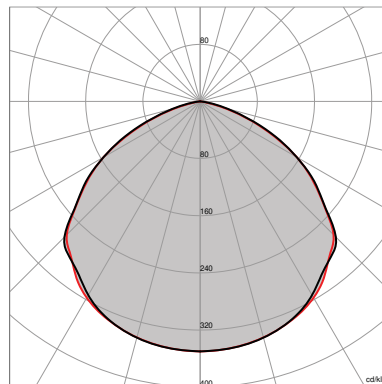

ESSENTIAL



Rimani aggiornato  
Keep up to date

# GAMMA PRODOTTI | PRODUCT RANGE

## INDUSTRIALI E COMMERCIALI INDUSTRIAL & COMMERCIAL



### LULY

p. 220

Corpo in lamiera di alluminio tornito verniciata con polveri epossidiche previa fosfatazione. Vetro temperato trasparente anti-shock termico. A richiesta sabbiato (cod. OP) o microprismatico (cod. MP). Guarnizione in silicone. Dissipatore in alluminio estruso e anodizzato. Connettore ad innesto rapido compreso di presa femmina in testata. Riflettore in alluminio tornito 99,85% ossidato e brillantato anodicamente per un elevato rendimento luminoso. Sistema di fissaggio a sospensione con gancio in acciaio zincato.

Sorgente luminosa LED. Emissione diretta. Non idonea per applicazioni all'esterno. Alimentazione elettronica CAE. A richiesta: DL (dimmerabile DALI).

*Spun sheet aluminium body painted with epoxy powders after phosphating. Tempered transparent thermal anti-shock glass. On request: sandblasted (code OP) or microprismatic (code MP). Silicon gasket. Extruded and anodized aluminium heatsink. Quick plug-in connector with female socket on endcover. Spun aluminium reflector 99,85% oxidized, anodized and polished for a high luminous efficiency. Suspension mounting system with galvanized steel hook. LED light source. Direct light emission. Not suitable for outdoor application. Built-in electronic driver CAE. On request: dimmable DALI (code DL).*



### BOLERO

p. 221

Corpo in lamiera di alluminio tornito verniciata con polveri epossidiche previa fosfatazione. Vetro temperato trasparente anti-shock termico. A richiesta sabbiato (cod. OP) o microprismatico (cod. MP). Guarnizione in silicone. Dissipatore in alluminio estruso e anodizzato. Connettore ad innesto rapido compreso di presa femmina in testata. Riflettore in alluminio tornito 99,85% ossidato e brillantato anodicamente per un elevato rendimento luminoso. Sistema di fissaggio a sospensione con gancio in acciaio zincato.

Sorgente luminosa LED. Emissione diretta. Non idonea per applicazioni all'esterno. Alimentazione elettronica CAE. A richiesta: DL (dimmerabile DALI).

*Spun sheet aluminium body painted with epoxy powders after phosphating. Tempered transparent thermal anti-shock glass. On request: sandblasted (code OP) or microprismatic (code MP). Silicon gasket. Extruded and anodized aluminium heatsink. Quick plug-in connector with female socket on endcover. Spun aluminium reflector 99,85% oxidized, anodized and polished for a high luminous efficiency. Suspension mounting system with galvanized steel hook. LED light source. Direct light emission. Not suitable for outdoor application. Built-in electronic driver CAE. On request: dimmable DALI (code DL).*



### PLIKE R - PLIKE Q

p. 222-223

Corpo in lamiera di acciaio pressopiegato, verniciata con polveri epossidiche previa fosfatazione. Telaio in estruso in alluminio verniciato. Ottica lenticolare in PC alto rendimento. Sistema di fissaggio a sospensione. Sorgente luminosa LED. Emissione diretta. Non idonea per l'applicazione esterna. Alimentazione elettronica CAE. A richiesta: dimmerabile DALI (cod. DL) specificare se con funzione PUSH DIM (cod. PD).

*Bent sheet steel body painted with epoxy powders after phosphating. Painted extruded aluminium frame. High performance polycarbonate lenticular optic. Suspension fixing system. LED light source. Direct light emission. Not suitable for outdoor application. Built in electronic driver CAE. On request: dimmable DALI (code DL) PUSH DIM function (code PD) to be requested.*



### SOTTILE R - SOTTILE Q

p. 224-225

Corpo in alluminio verniciato con polveri epossidiche. Ottica lenticolare alto rendimento in PMMA. Sistema fissaggio a sospensione. Sorgente LED. Emissione diretta. Alimentazione elettronica CAE. A richiesta: dimmerabile DALI (cod. DL) specificare se con funzione PUSH DIM (cod. PD).

*Aluminium body painted with epoxy powders after phosphating. High performance PMMA lenticular optic. Suspension fixing system. LED light source. Direct light emission. Not suitable for outdoor application. Built in electronic driver CAE. On request: dimmable DALI (code DL) PUSH DIM function (code PD) to be requested.*



# FOTOMETRIE | PHOTOMETRIES

INDUSTRIALI E COMMERCIALI  
INDUSTRIAL & COMMERCIAL

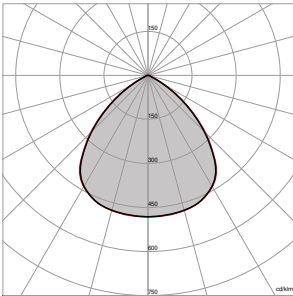

**LULY**

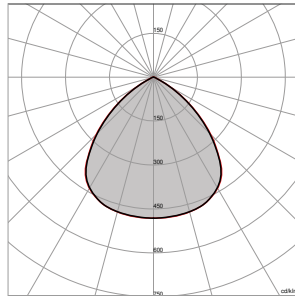

**BOLERO**

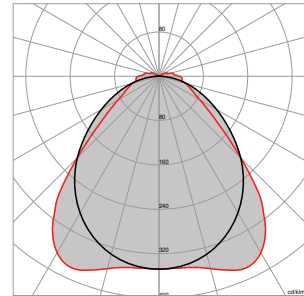

**PLIKE R - PLIKE Q**  
Fascio/Beam | LA

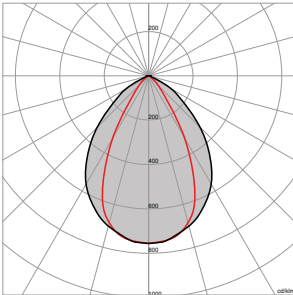

**PLIKE R - PLIKE Q**  
Fascio/Beam | MD

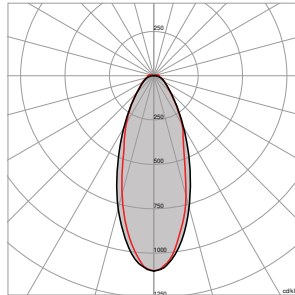

**PLIKE R - PLIKE Q**  
Fascio/Beam | ST

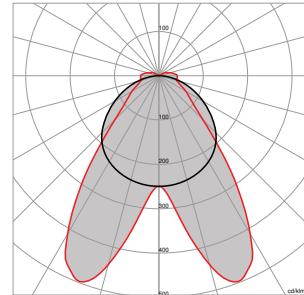

**PLIKE R - PLIKE Q**  
Fascio/Beam | BT

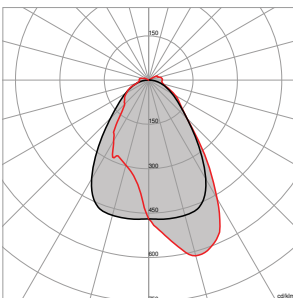

**PLIKE R - PLIKE Q**  
Fascio/Beam | AS

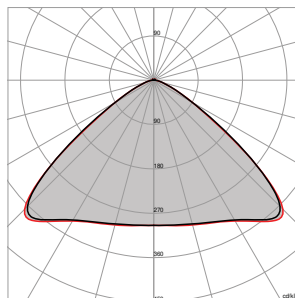

**SOTTILE R - SOTTILE Q**  
Fascio/Beam | LA

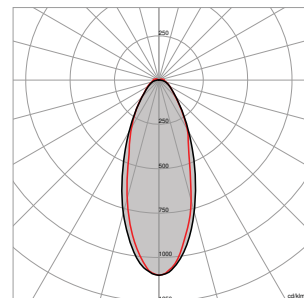

**SOTTILE R - SOTTILE Q**  
Fascio/Beam | ST

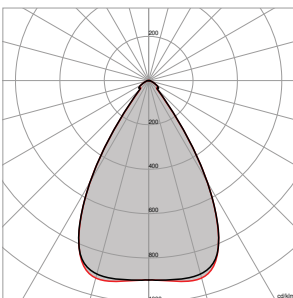

**SOTTILE R - SOTTILE Q**  
Fascio/Beam | HR

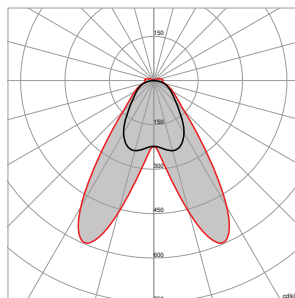

**SOTTILE R - SOTTILE Q**  
Fascio/Beam | BT



Rimani aggiornato  
Keep up to date

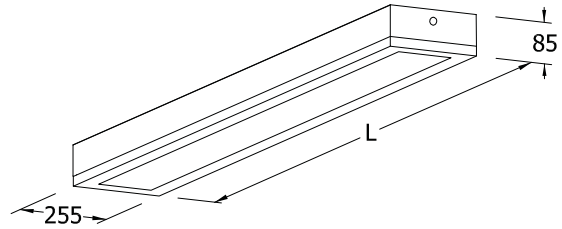

# AMBI U

Apparecchio LED a sospensione. **Optica diffondente.** Presa femmina per alimentazione da cablare (7PR3702-V) **inclusa lunghezza 54 mm.**  
 LED suspension lighting fittings. **Wide optic.** Female socket to be wired (7PR3702-V) **included length 54 mm.**

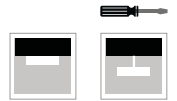

**5Y WARRANTY**  
5% FAILURE RATE

**60.000 h**  
LED LIFETIME L90B10

**100.000 h**  
LED LIFETIME L70B50

**A RICHIESTA | ON REQUEST**

>90  
CRI

EM  
EN 60598-2-22

DL  
DALI

PD  
PUSH DIM

WIRELESS

Relamping	Lumen LED*	Watt LED**	Lumen Out***	Watt	Lumen Watt Out	L Lunghezza L Length	Configurazione LED LED configuration	Code Code	K	Alimentazione Power Supply	Colore Colour
2X36	<b>6420</b>	32	5000	34,5	> 145	1185 mm	=====	<b>AMU33</b>	N: 4.000	- : CAE A RICHIESTA   ON REQUEST DL: DALI PD: PUSH DIM	<b>01:</b> bianco white
2X58	<b>8390</b>	44	6544	47,5	> 138	1185 mm	=====	<b>AMU50</b>			
2X58	<b>8620</b>	43	6670	46	> 145	1560 mm	=====	<b>AMU43</b>			
2X80	<b>11200</b>	59	8695	63	> 138	1560 mm	=====	<b>AMU66</b>			
4X36	<b>12840</b>	64	10000	69	> 145	1185 mm	=====	<b>AMU60</b>	N: 4.000	- : CAE A RICHIESTA   ON REQUEST DL: DALI PD: PUSH DIM	<b>01:</b> bianco white
4X58	<b>16680</b>	88	13088	95	> 138	1185 mm	=====	<b>AMU100</b>			
4X58	<b>17240</b>	86	13320	92	> 145	1560 mm	=====	<b>AMU80</b>			
4X80	<b>22400</b>	118	17390	126	> 138	1560 mm	=====	<b>AMU132</b>			

>80  
CRI

IP55  
EN 60529

230 V  
2014/35/UE

50/60  
Hz

IK 07  
EN 60068

850°  
EN 60695

RG 0  
EN 62471

01  
WHITE

**AMU33 - AMU43 - AMU60 - AMU80**  
 TEMPERATURA AMBIENTE MIN E MAX | MIN AND MAX ROOM TEMPERATURE: (-20° +45°)

**AMU50 - AMU66 - AMU100 - AMU132**  
 TEMPERATURA AMBIENTE MIN E MAX | MIN AND MAX ROOM TEMPERATURE: (-20° +40°)

\* Lumen nominali LED max a 25° | Nominal lumen at max 25°  
 \*\* Potenza dei LED | LED power  
 \*\*\* Flusso totale in uscita dall'apparecchio a temperatura di lavoro (Ta 25° - 4.000 K) | Total lighting fitting flux output at working temperature (Ta 25° - 4.000 K) | (3.000 K -8% - CRI 90 -10%)

- A RICHIESTA / ON REQUEST**
- **AMBI-ST:** Kit plafone per AMBI | Ceiling fixings system kit for AMBI
  - Apparecchio AMBI U versione fino a 38.000 lm | Fixture AMBI U version up to 38.000 lm
  - Griglia di protezione | Protection grid



Fotometrie | Photometries  
 p. 203



Schema di cablaggio | Connection scheme  
 p. XXVIII-XXIX



Descrizione prodotto | Product description  
 p. 202

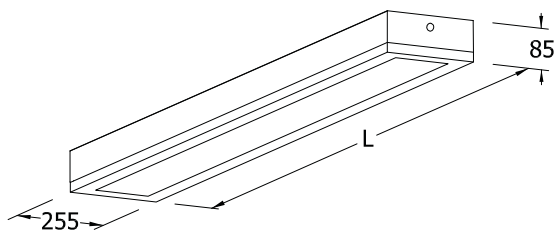

# AMBI I

Apparecchio LED a sospensione. **Ottica concentrante.** Presa femmina per alimentazione da cablare (7PR3702-V) **inclusa lunghezza 54 mm.** LED lighting fittings. **Narrow optic.** Female socket to be wired (7PR3702-V) **included length 54 mm.**



**A RICHIESTA | ON REQUEST**

>90 CRI
EM EN 60570-2-22
DL DALI
PD PUSH DIM
WIRELESS
⚡

**5Y WARRANTY**  
5% FAILURE RATE
**60.000 h**  
LED LIFETIME L90B10
**100.000 h**  
LED LIFETIME L70B50

Relamping	Lumen LED*	Watt LED**	Lumen Out***	Watt	Lumen Watt Out	L Lunghezza L Length	Configurazione LED LED configuration	Code Code	K	Alimentazione Power Supply	Colore Colour
2x58	<b>8390</b>	44	5830	47,5	> 122	1185 mm	=====	<b>AMI50</b>	N: 4.000	— : CAE A RICHIESTA   ON RE- QUEST DL: DALI PD: PUSH DIM	<b>01:</b> bianco white
2x80	<b>11200</b>	59	7765	63	> 122	1560 mm	=====	<b>AMI66</b>			
4x68	<b>16780</b>	88	11660	95	> 122	1185 mm	=====	<b>AMI100</b>	N: 4.000	— : CAE A RICHIESTA   ON REQUEST DL: DALI PD: PUSH DIM	<b>01:</b> bianco white
4x80	<b>22400</b>	118	15550	126	> 122	1560 mm	=====	<b>AMI132</b>			

CE
⊕
>80 CRI
IP55 EN 60529
230 V 2014/35/UE
50/60 Hz
IK 07 EN 60068
  
850° EN 60695
A++ A+ A
RG 0 EN 62471
🏠
01 WHITE

TEMPERATURA AMBIENTE MIN E MAX | MIN AND MAX ROOM TEMPERATURE: (-20° +40°)

\* Lumen nominali LED max a 25° | Nominal lumen at max 25°

\*\* Potenza dei LED | LED power

\*\*\* Flusso totale in uscita dall'apparecchio a temperatura di lavoro (Ta 25° - 4.000 K) | Total lighting fitting flux output at working temperature (Ta 25° - 4.000 K) | (3.000 K -8% - CRI 90 -10%)

**A RICHIESTA / ON REQUEST**

- **AMBI-ST:** Kit plafone per AMBI | Ceiling fixings system kit for AMBI
- Apparecchio AMBI I versione fino a 38.000 lm | Fixture AMBI I version up to 38.000 lm
- Griglia di protezione | Protection grid

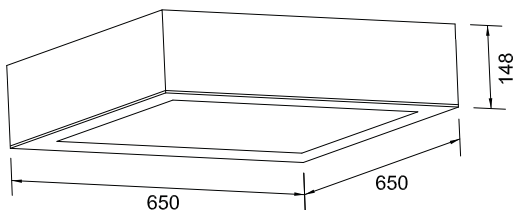

# FUTURA

Apparecchio LED a sospensione per l'illuminazione di aree industriali e commerciali. Schermo in policarbonato microprismato.  
LED suspension lighting fittings for industrial and commercial areas.  
Microprismatic polycarbonate diffuser.



**A RICHIESTA | ON REQUEST**

<b>5Y WARRANTY</b> 5% FAILURE RATE	<b>60.000 h</b> LED LIFETIME L90B10	<b>100.000 h</b> LED LIFETIME L70B50
---------------------------------------	--	---



Relamping	Lumen LED*	Watt LED**	Lumen Out***	Watt	Lumen Watt Out	Configurazione LED LED configuration	Codice Code	K	Alimentazione Power Supply	Colore Colour
4X40	<b>11680</b>	63	9580	67,5	> 142	=====	<b>FUL6MP</b>		— : CAE	
4X55	<b>16400</b>	94	13450	100	> 135	=====	<b>FUL10MP</b>	N: 4.000	A RICHIESTA   ON REQUEST DL: DALI PD: PUSH DIM	<b>01:</b> bianco white

CE		>80 CRI	IP44 EN 60529	230 V 2014/35/UE	50/60 Hz	IK 07 EN 60068
850° EN 60695	A++ A+ A	RG 0 EN 62471		01 WHITE	19 UGR	

**FUL6MP**  
TEMPERATURA AMBIENTE MIN E MAX | MIN AND MAX ROOM TEMPERATURE: (-20° +45°)

**FUL10MP**  
TEMPERATURA AMBIENTE MIN E MAX | MIN AND MAX ROOM TEMPERATURE: (-20° +40°)

\* Lumen nominali LED max a 25° | Nominal lumen at max 25°

\*\* Potenza dei LED | LED power

\*\*\* Flusso totale in uscita dall'apparecchio a temperatura di lavoro (Ta 25° - 4.000 K) | Total lighting fitting flux output at working temperature (Ta 25° - 4.000 K) | (3.000 K -8% - CRI 90 -10%)

**A RICHIESTA / ON REQUEST**

- Versione per installazione a plafone | Ceiling fixing system version
- Griglia di protezione | Protection grid



Fotometrie | Photometries  
p. 203



Schema di cablaggio | Connection scheme  
p. XXVIII-XXIX



Descrizione prodotto | Product description  
p. 202

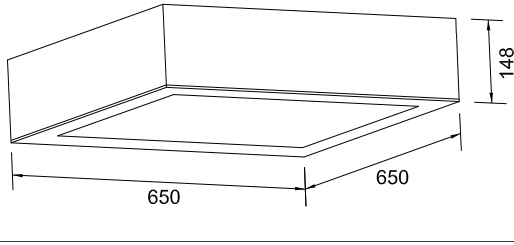

# FUTURA PLUS

Apparecchio LED a sospensione per l'illuminazione di aree industriali e commerciali. Schermo in policarbonato microprismato.  
*LED suspension lighting fittings for industrial and commercial areas.  
 Microprismatic polycarbonate diffuser.*



**A RICHIESTA | ON REQUEST**



<b>5Y WARRANTY</b> 5% FAILURE RATE	<b>60.000 h</b> LED LIFETIME L90B10	<b>100.000 h</b> LED LIFETIME L70B50
---------------------------------------	--	---

Relamping	Lumen LED*	Watt LED**	Lumen Out***	Watt	Lumen Watt Out	Configurazione LED LED configuration	Codice Code	K	Alimentazione Power Supply	Colore Colour
4X55	<b>16400</b>	98	14175	105	> 135		<b>FUL8MP</b>	N: 4.000	— : CAE A RICHIESTA   ON REQUEST DL: DALI PD: PUSH DIM	<b>01:</b> bianco white
6X40	<b>20500</b>	117	16870	125	> 135		<b>FUL9MP</b>			
6X55	<b>24600</b>	140	20250	150	> 135		<b>FUL14MP</b>			



**FUL8MP - FUL9MP**  
 TEMPERATURA AMBIENTE MIN E MAX | MIN AND MAX ROOM TEMPERATURE: (-20° +45°)

**FUL14MP**  
 TEMPERATURA AMBIENTE MIN E MAX | MIN AND MAX ROOM TEMPERATURE: (-20° +35°)

\* Lumen nominali LED max a 25° | Nominal lumen at max 25°  
 \*\* Potenza dei LED | LED power  
 \*\*\* Flusso totale in uscita dall'apparecchio a temperatura di lavoro (Ta 25° - 4.000 K) | Total lighting fitting flux output at working temperature (Ta 25° - 4.000 K) | (3.000 K -8% - CRI 90 -10%)

**A RICHIESTA / ON REQUEST**

- Versione per installazione a plafone | Ceiling fixing system version
- Griglia di protezione | Protection grid

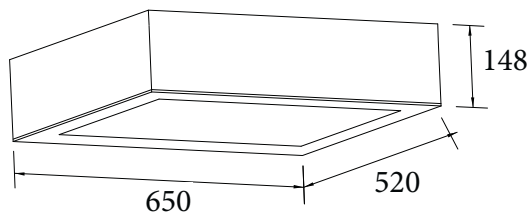

# FUTURA SMALL

Apparecchio LED a sospensione per l'illuminazione di aree industriali e commerciali. Schermo in policarbonato microprismato.  
LED suspension lighting fittings for industrial and commercial areas.  
Microprismatic polycarbonate diffuser.



**A RICHIESTA | ON REQUEST**

<b>5Y WARRANTY</b> 5% FAILURE RATE	<b>60.000 h</b> LED LIFETIME L90B10	<b>100.000 h</b> LED LIFETIME L70B50
---------------------------------------	--	---



Relamping	Lumen LED*	Watt LED**	Lumen Out***	Watt	Lumen Watt Out	Configurazione LED LED configuration	Codice Code	K	Alimentazione Power Supply	Colore Colour
4X36	<b>11680</b>	64	9580	68	> 140	=====	<b>FULS7MP</b>		— : CAE	
4X55	<b>16400</b>	95	12800	101	> 126	=====	<b>FULS4MP</b>	<b>N 4.000 K</b>	A RICHIESTA   ON REQUEST <b>DL:</b> DALI <b>PD:</b> PUSH DIM	<b>01:</b> bianco white

<b>CE</b>		<b>&gt;80</b> CRI	<b>IP40</b> EN 60529	<b>230 V</b> 2014/35/UE	<b>50/60</b> Hz	<b>IK 07</b> EN 60068
<b>850°</b> EN 60695	<b>A+</b> A	<b>RG 0</b> EN 62471		<b>01</b> WHITE	<b>19</b> UGR	

TEMPERATURA AMBIENTE MIN E MAX | MIN AND MAX ROOM TEMPERATURE: (-10° +40°)

\* Lumen nominali LED max a 25° | Nominal lumen at max 25°

\*\* Potenza dei LED | LED power

\*\*\* Flusso totale in uscita dall'apparecchio a temperatura di lavoro (Ta 25° - 4.000 K) | Total lighting fitting flux output at working temperature (Ta 25° - 4.000 K) | (3.000 K -8% - CRI 90 -10%)

#### A RICHIESTA / ON REQUEST

- Versione per installazione a plafone | Ceiling fixing system version
- Griglia di protezione | Protection grid



Fotometrie | Photometries  
p. 203



Schema di cablaggio | Connection scheme  
p. XXVIII-XXIX



Descrizione prodotto | Product description  
p. 202





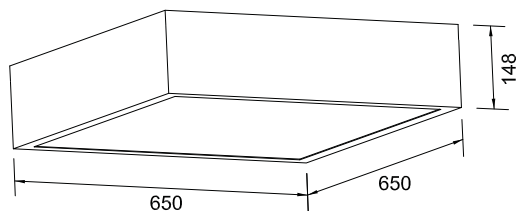

# FUTURA IP55D

Apparecchio LED a sospensione per l'illuminazione di aree industriali e commerciali. Schermo in vetro.  
LED suspension lighting fittings for industrial and commercial areas.  
Glass screen.



<b>5Y WARRANTY</b> 5% FAILURE RATE	<b>60.000 h</b> LED LIFETIME L90B10	<b>100.000 h</b> LED LIFETIME L70B50
---------------------------------------	--	---

**A RICHIESTA | ON REQUEST**

>90 CRI	EM EN 60598-2-22	DL DALI	PD PUSH DIM	WIRELESS	⚡
------------	---------------------	------------	----------------	----------	---

Relamping	Lumen LED*	Watt LED**	Lumen Out***	Watt	Lumen Watt Out	Configurazione LED LED configuration	Codice Code	K	Alimentazione Power Supply	Colore Colour
4X55	14600	79	12400	84,5	> 146		FUIP8	N 4.000 K	— : CAE A RICHIESTA   ON REQUEST DL: DALI PD: PUSH DIM	01: bianco white
6X40	20500	117	17500	125	> 140		FUIP9			

CE		>80 CRI	IP55 EN 60529	230 V 2014/35/UE	50/60 Hz	IK 04 EN 60068
850° EN 60695	A++ A+ A	RG 0 EN 62471		01 WHITE		

TEMPERATURA AMBIENTE MIN E MAX | MIN AND MAX ROOM TEMPERATURE: (-20° +35°)

\* Lumen nominali LED max a 25° | Nominal lumen at max 25°

\*\* Potenza dei LED | LED power

\*\*\* Flusso totale in uscita dall'apparecchio a temperatura di lavoro (Ta 25° - 4.000 K) | Total lighting fitting flux output at working temperature (Ta 25° - 4.000 K) | (3.000 K -8% - CRI 90 -10%)

**A RICHIESTA / ON REQUEST**

- Versione per installazione a plafone | Ceiling fixing system version
- Griglia di protezione | Protection grid



Fotometrie | Photometries  
p. 205



Schema di cablaggio | Connection scheme  
p. XXVIII-XXIX



Descrizione prodotto | Product description  
p. 204





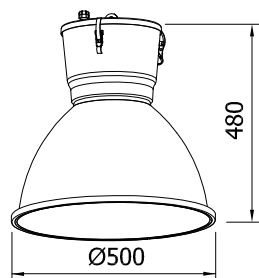

# DUNDI LED

Sospensione industriale a LED per l'illuminazione di capannoni e di aree commerciali IP65D.

IP65D LED industrial suspension fitting for lighting warehouses and commercial areas.



**5Y WARRANTY**  
5% FAILURE RATE

**60.000 h**  
LED LIFETIME L90B10

**100.000 h**  
LED LIFETIME L70B50

**>90**  
CRI

**EM**  
EN 60598-2-22

**DL**  
DALI

**PD**  
PUSH DIM

**WIRELESS**



**A RICHIESTA | ON REQUEST**

Relamping	Lumen LED*	Watt LED**	Lumen Out***	Watt	Lumen Watt Out	Configurazione LED LED configuration	Codice Code	K	Alimentazione Power Supply	Colore Colour
1x150	<b>10500</b>	55	8280	59	> 140	○	<b>DN441L65</b>		— : CAE	
1x250	<b>15000</b>	77	11250	82,5	> 136	○	<b>DN441L85</b>	<b>N:</b> 4.000	<b>A RICHIESTA   ON REQUEST</b> <b>DL:</b> DALI <b>PD:</b> PUSH DIM	<b>02:</b> nero black

<b>CE</b>		<b>&gt;80</b> CRI	<b>IP65</b> EN 60529	<b>230 V</b> 2014/35/UE	<b>50/60</b> Hz	<b>IK 07</b> EN 60068
<b>850°</b> EN 60695		<b>RG 0</b> EN 62471		<b>02</b> BLACK		

TEMPERATURA AMBIENTE MIN E MAX | MIN AND MAX ROOM TEMPERATURE: (-20° +40°)

\* Lumen nominali LED max a 25° | Nominal lumen at max 25°

\*\* Potenza dei LED | LED power

\*\*\* Flusso totale in uscita dall'apparecchio a temperatura di lavoro (Ta 25° - 4.000 K) | Total lighting fitting flux output at working temperature (Ta 25° - 4.000 K) | (3.000 K -8% - CRI 90 -10%)

**A RICHIESTA / ON REQUEST**

- Griglia di protezione | Protection grid
- Vetro sabbaiato | Sandblasted glass



Fotometrie | Photometries  
p. 205



Schema di cablaggio | Connection scheme  
p. XXVIII-XXIX



Descrizione prodotto | Product description  
p. 204

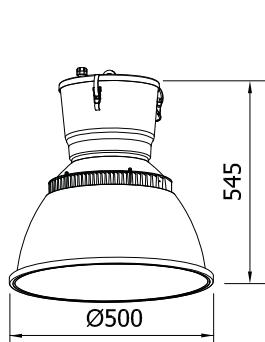

# DN LED

Sospensione industriale a LED per l'illuminazione di capannoni e di aree commerciali IP65D. *IP65D LED industrial suspension fitting for lighting warehouses and commercial areas.*



**A RICHIESTA | ON REQUEST**



Relamping	Lumen LED*	Watt LED**	Lumen Out***	Watt	Lumen Watt Out	Configurazione LED LED configuration	Code Code	K	Alimentazione Power Supply	Colore Colour
<b>Altezza / Height 498 mm</b>										
1x250	<b>20000</b>	113,5	15850	122	> 130	○	<b>DNL140</b>	<b>N:</b> 4.000	— : CAE A RICHIESTA   ON REQUEST <b>DL:</b> DALI <b>PD:</b> PUSH DIM	<b>02:</b> nero black
<b>Altezza / Height 545 mm</b>										
1x400	<b>28000</b>	162	21210	174	> 122	○	<b>DNL185</b>	<b>N:</b> 4.000	— : CAE A RICHIESTA   ON REQUEST <b>DL:</b> DALI <b>PD:</b> PUSH DIM	<b>02:</b> nero black
1x400	<b>35000</b>	242,5	26500	259	> 102	○	<b>DNL270</b>			



TEMPERATURA AMBIENTE MIN E MAX | MIN AND MAX ROOM TEMPERATURE: (-20° +40°)

\* Lumen nominali LED max a 25° | Nominal lumen at max 25°

\*\* Potenza dei LED | LED power

\*\*\* Flusso totale in uscita dall'apparecchio a temperatura di lavoro (Ta 25° - 4.000 K) | Total lighting fitting flux output at working temperature (Ta 25° - 4.000 K) | (3.000 K -8% - CRI 90 -10%)

**A RICHIESTA / ON REQUEST**

- Griglia di protezione | Protection grid
- Vetro sabbaiato | Sandblasted glass

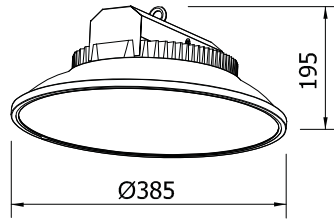

# ESSENTIAL COB

Sospensione industriale a LED per l'illuminazione di capannoni e di aree commerciali IP65D.  
*IP65D LED industrial suspension fitting for lighting warehouses and commercial areas.*



<b>5Y WARRANTY</b> 5% FAILURE RATE	<b>60.000 h</b> LED LIFETIME <b>L90B10</b>	<b>100.000 h</b> LED LIFETIME <b>L70B50</b>
---------------------------------------	---	--

**A RICHIESTA | ON REQUEST**

<b>&gt;90</b> CRI	<b>EM</b> EN 60598-2-22	<b>DL</b> DALI	<b>PD</b> PUSH DIM	<b>WIRELESS</b>	
----------------------	----------------------------	-------------------	-----------------------	-----------------	--

Relamping	Lumen LED*	Watt LED**	Lumen Out***	Watt	Lumen Watt Out	Configurazione LED LED configuration	Code Code	K	Alimentazione Power Supply	Colore Colour
1x400	<b>24200</b>	135	18240	144	> 144	○	<b>DNEC150</b>	<b>N:</b> 4.000	— : CAE A RICHIESTA   ON REQUEST <b>DL:</b> DALI <b>PD:</b> PUSH DIM	<b>02:</b> nero black

<b>CE</b>		<b>&gt;80</b> CRI	<b>IP65</b> EN 60529	<b>230 V</b> 2014/35/UE	<b>50/60</b> Hz	<b>IK 09</b> EN 60068
<b>850°</b> EN 60695	<b>A++</b> A+ A	<b>RG 0</b> EN 62471		<b>02</b> BLACK		

TEMPERATURA AMBIENTE MIN E MAX | MIN AND MAX ROOM TEMPERATURE: **(-20° +40°)**

\* Lumen nominali LED max a 25° | Nominal lumen at max 25°

\*\* Potenza dei LED | LED power

\*\*\* Flusso totale in uscita dall'apparecchio a temperatura di lavoro (Ta 25° - 4.000 K) | Total lighting fitting flux output at working temperature. (Ta 25° - 4.000 K) | (3.000 K -8% - CRI 90 -10%)

**A RICHIESTA / ON REQUEST**

- Griglia di protezione | Protection grid



Fotometrie | Photometries  
p. 205



Schema di cablaggio | Connection scheme  
p. XXVIII-XXIX



Descrizione prodotto | Product description  
p. 204



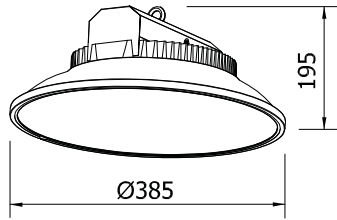

# ESSENTIAL

Sospensione industriale a LED per l'illuminazione di capannoni e di aree commerciali IP65D. *IP65D LED industrial suspension fitting for lighting warehouses and commercial areas.*



**A RICHIESTA | ON REQUEST**



**5Y WARRANTY**  
5% FAILURE RATE

**60.000 h**  
LED LIFETIME L90B10

**100.000 h**  
LED LIFETIME L70B50

Relamping	Lumen LED*	Watt LED**	Lumen Out***	Watt	Lumen Watt Out	Configurazione LED LED configuration	Codice Code	K	Alimentazione Power Supply	Colore Colour
1x250	<b>20000</b>	136	15620	140	> 112	○	<b>DNE150</b>	N: 4.000	— : CAE A RICHIESTA   ON REQUEST DL: DALI PD: PUSH DIM	<b>02:</b> nero black
1x400	<b>24624</b>	160	17000	170	> 100	○	<b>DNE170</b>			
1x400	<b>28000</b>	162	21210	174	> 122	○	<b>DNE185</b>			



TEMPERATURA AMBIENTE MIN E MAX | MIN AND MAX ROOM TEMPERATURE: (-20° +40°)

\* Lumen nominali LED max a 25° | Nominal lumen at max 25°

\*\* Potenza dei LED | LED power

\*\*\* Flusso totale in uscita dall'apparecchio a temperatura di lavoro (Ta 25° - 4.000 K) | Total lighting fitting flux output at working temperature (Ta 25° - 4.000 K) | (3.000 K -8% - CRI 90 -10%)

**A RICHIESTA / ON REQUEST**

- Griglia di protezione | Protection grid

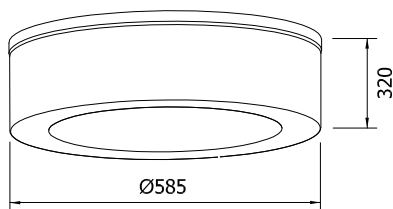

# LULY

Sospensione industriale a LED per l'illuminazione di capannoni e di aree commerciali IP65D.

IP65D LED industrial suspension fitting for lighting warehouses and commercial areas



**5Y WARRANTY**  
5% FAILURE RATE

**60.000 h**  
LED LIFETIME L90B10

**100.000 h**  
LED LIFETIME L70B50

A RICHIESTA | ON REQUEST



Relamping	Lumen LED*	Watt LED**	Lumen Out***	Watt	Lumen Watt Out	Configurazione LED LED configuration	Code Code	K	Alimentazione Power Supply	Colore Colour
1x150	<b>10500</b>	55	8280	59	> 140	○	<b>LU DL64</b>	<b>N:</b> 4.000	— : CAE A RICHIESTA   ON REQUEST <b>DL:</b> DALI <b>PD:</b> PUSH DIM	<b>63:</b> grafite graphite
1x250	<b>15000</b>	77	11250	82,5	> 136	○	<b>LU DL85</b>			
1x250	<b>20000</b>	113,5	15850	122	> 130	○	<b>LU DL140</b>			
1x400	<b>28000</b>	162	21210	174	> 122	○	<b>LU DL185</b>			
1x400	<b>35000</b>	242,5	26500	259	> 102	○	<b>LU DL270</b>			



TEMPERATURA AMBIENTE MIN E MAX | MIN AND MAX ROOM TEMPERATURE: (-20° +40°)

\* Lumen nominali LED max a 25° | Nominal lumen at max 25°

\*\* Potenza dei LED | LED power

\*\*\* Flusso totale in uscita dall'apparecchio a temperatura di lavoro (Ta 25° - 4.000 K) | Total lighting fitting flux output at working temperature (Ta 25° - 4.000 K) | (3.000 K -8% - CRI 90 -10%)

**A RICHIESTA / ON REQUEST**

- Griglia di protezione | Protection grid



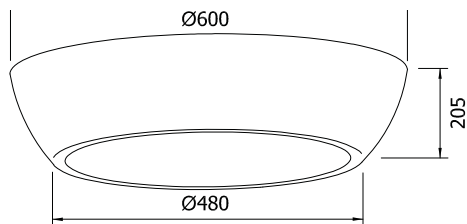

# BOLERO

Sospensione industriale a LED per l'illuminazione di capannoni e di aree commerciali IP65D.  
*IP65D LED industrial suspension fitting for lighting warehouses and commercial areas.*



**A RICHIESTA | ON REQUEST**



Relamping	Lumen LED*	Watt LED**	Lumen Out***	Watt	Lumen Watt Out	Configurazione LED LED configuration	Codice Code	K	Alimentazione Power Supply	Colore Colour
1x150	<b>10500</b>	55	8280	59	> 140	○	<b>BOL64</b>	<b>N:</b> 4.000	— : CAE A RICHIESTA   ON REQUEST <b>DL:</b> DALI <b>PD:</b> PUSH DIM	<b>63:</b> grafite graphite
1x250	<b>15000</b>	77	11250	82,5	> 136	○	<b>BOL85</b>			
1x250	<b>20000</b>	113,5	15850	122	> 130	○	<b>BOL140</b>			
1x400	<b>28000</b>	162	21210	174	> 122	○	<b>BOL185</b>			
1x400	<b>35000</b>	242,5	26500	259	> 102	○	<b>BOL270</b>			



TEMPERATURA AMBIENTE MIN E MAX | MIN AND MAX ROOM TEMPERATURE: (-20° +40°)

\* Lumen nominali LED max a 25° | Nominal lumen at max 25°

\*\* Potenza dei LED | LED power

\*\*\* Flusso totale in uscita dall'apparecchio a temperatura di lavoro (Ta 25° - 4.000 K) | Total lighting fitting flux output at working temperature (Ta 25° - 4.000 K) | (3.000 K -8% - CRI 90 -10%)

**A RICHIESTA / ON REQUEST**

- Versione per installazione a plafone | Ceiling fixing system version
- Griglia di protezione | Protection grid

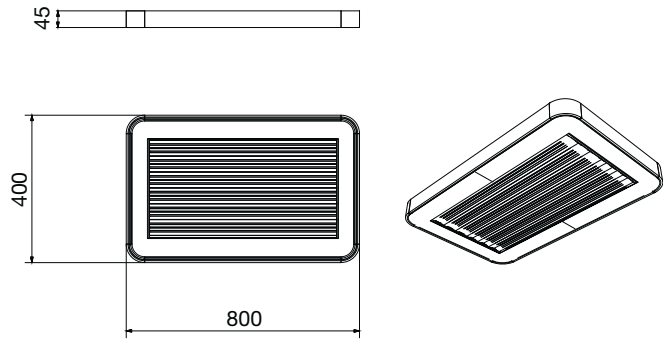

# PLIKE R

Sospensione industriale a LED per l'illuminazione di capannoni e di aree commerciali IP43.  
 IP43 LED industrial suspension fitting for lighting warehouses and commercial areas.



**5Y WARRANTY**  
5% FAILURE RATE

**60.000 h**  
LED LIFETIME L90B10

**100.000 h**  
LED LIFETIME L70B50

A RICHIESTA | ON REQUEST

**>90**  
CRI

**EM**  
EN 60598-2-22

**DL**  
DALI

**PD**  
PUSH DIM

**WIRELESS**

Relamping	Lumen LED*	Watt LED**	Lumen Out***	Watt	Lumen Watt Out	Configurazione LED LED configuration	Codice Code	Lenti Lens	K	Alimentazione Power Supply	Colore Colour
4x55	<b>12220</b>	66	11680	70	> 166		<b>PE256</b>	LA	W: 3.000 N: 4.000 C: 6.000	— : CAE A RICHIESTA   ON REQUEST DL: DALI PD: PUSH DIM	<b>01:</b> bianco white
4x80	<b>17520</b>	95	16100	100	> 160		<b>PE306</b>				
4x55	<b>12220</b>	66	11680	70	> 166		<b>PE256</b>	MD			
4x80	<b>17520</b>	95	16100	100	> 160		<b>PE306</b>				
4x55	<b>12220</b>	66	11680	70	> 166		<b>PE256</b>	ST			
4x80	<b>17520</b>	95	16100	100	> 160		<b>PE306</b>				
4x55	<b>12220</b>	66	11680	70	> 166		<b>PE256</b>	BT			
4x80	<b>17520</b>	95	16100	100	> 160		<b>PE306</b>				
4x55	<b>12220</b>	66	11680	70	> 166		<b>PE256</b>	AS			
4x80	<b>17520</b>	95	16100	100	> 160		<b>PE306</b>				

**>80**  
CRI

**IP43**  
EN 60529

**230 V**  
2014/35/UE

**50/60**  
Hz

**IK 07**  
EN 60068

**850°**  
EN 60695

**RG 0**  
EN 62471

**01**  
WHITE

TEMPERATURA AMBIENTE MIN E MAX | MIN AND MAX ROOM TEMPERATURE: (-10° +40°)

\* Lumen nominali LED max a 25° | Nominal lumen at max 25°

\*\* Potenza dei LED | LED power

\*\*\* Flusso totale in uscita dall'apparecchio a temperatura di lavoro (Ta 25° - 4.000 K) | Total lighting fitting flux output at working temperature (Ta 25° - 4.000 K) | (3.000 K -8% - CRI 90 -10%)

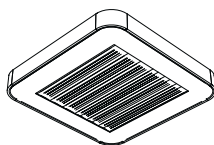
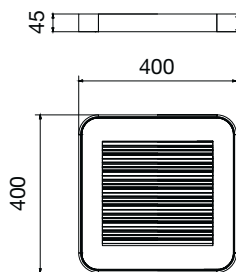

# PLIKE Q

Sospensione industriale a LED per l'illuminazione di capannoni e di aree commerciali IP43. IP43 LED industrial suspension fitting for lighting warehouses and commercial areas.



**A RICHIESTA | ON REQUEST**

>90 CRI
EM EN 60598-2-22
DL DALI
PD PUSH DIM
WIRELESS
⚡

**5Y WARRANTY**  
5% FAILURE RATE

**60.000 h**  
LED LIFETIME L90B10

**100.000 h**  
LED LIFETIME L70B50

Relamping	Lumen LED*	Watt LED**	Lumen Out***	Watt	Lumen Watt Out	Configurazione LED LED configuration	Code Code	Lenti Lens	K	Alimentazione Power Supply	Colore Colour
4x55	<b>8760</b>	48	8040	51	> 157	▬▬▬▬	<b>PE356</b>	LA	W: 3.000 N: 4.000 C: 6.000	— : CAE A RICHIESTA   ON REQUEST DL: DALI PD: PUSH DIM	<b>01:</b> bianco white
4x55	<b>12300</b>	70	11294	74	> 152	▬▬▬▬	<b>PE506</b>				
4x55	<b>8760</b>	48	8040	51	> 157	▬▬▬▬	<b>PE356</b>	MD			
4x55	<b>12300</b>	70	11294	74	> 152	▬▬▬▬	<b>PE506</b>				
4x55	<b>8760</b>	48	8040	51	> 157	▬▬▬▬	<b>PE356</b>	ST			
4x55	<b>12300</b>	70	11294	74	> 152	▬▬▬▬	<b>PE506</b>				
4x55	<b>8760</b>	48	8040	51	> 157	▬▬▬▬	<b>PE356</b>	BT			
4x55	<b>12300</b>	70	11294	74	> 152	▬▬▬▬	<b>PE506</b>				
4x55	<b>8760</b>	48	8040	51	> 157	▬▬▬▬	<b>PE356</b>	AS			
4x55	<b>12300</b>	70	11294	74	> 152	▬▬▬▬	<b>PE506</b>				

CE
⚡
>80 CRI
IP43 EN 60529
230 V 2014/35/UE
50/60 Hz
IK 07 EN 60668
  
850° EN 60695
Δ++
RG 0 EN 62471
🏠
01 WHITE

TEMPERATURA AMBIENTE MIN E MAX | MIN AND MAX ROOM TEMPERATURE: (-10° +40°)

\* Lumen nominali LED max a 25° | Nominal lumen at max 25°

\*\* Potenza dei LED | LED power

\*\*\* Flusso totale in uscita dall'apparecchio a temperatura di lavoro (Ta 25° - 4.000 K) | Total lighting fitting flux output at working temperature (Ta 25° - 4.000 K) | (3.000 K -8% - CRI 90 -10%)

Descrizione prodotto | Product description p. 206

Schema di cablaggio | Connection scheme p. XXVIII-XXIX

Fotometrie | Photometries p. 206



# SOTTILE R

Sospensione industriale a LED per l'illuminazione di capannoni e di aree commerciali IP43. IP43 LED industrial suspension fitting for lighting warehouses and commercial areas.

**5Y WARRANTY**  
5% FAILURE RATE

**60.000 h**  
LED LIFETIME L90B10

**100.000 h**  
LED LIFETIME L70B50

Relamping	Lumen LED*	Watt LED**	Lumen Out***	Watt	Lumen Watt Out	Configurazione LED LED configuration	Codice Code	Lenti Lens	K	Alimentazione Power Supply	Colore Colour
4x55	<b>13800</b>	82	12640	86	> 146	=====	<b>SO354</b>	LA	W: 3.000 N: 4.000 C: 6.000	— : CAE A RICHIESTA   ON REQUEST DL: DALI PD: PUSH DIM	<b>01:</b> bianco white
4x80	<b>19000</b>	122	17415	128	> 136	=====	<b>SO504</b>				
4x55	<b>13800</b>	82	12640	86	> 146	=====	<b>SO354</b>	ST			
4x80	<b>19000</b>	122	17415	128	> 136	=====	<b>SO504</b>				
4x55	<b>13800</b>	82	12640	86	> 146	=====	<b>SO354</b>	HR			
4x80	<b>19000</b>	122	17415	128	> 136	=====	<b>SO504</b>				
4x55	<b>13800</b>	82	12640	86	> 146	=====	<b>SO354</b>	BT			
4x80	<b>19000</b>	122	17415	128	> 136	=====	<b>SO504</b>				

CE

>80  
CRI

IP43  
EN 60529

230 V  
2014/35/UE

50/60  
Hz

IK 07  
EN 60068

850°  
EN 60695

A++  
A+  
A

RG 0  
EN 62471

01  
WHITE

TEMPERATURA AMBIENTE MIN E MAX | MIN AND MAX ROOM TEMPERATURE: (-10° +40°)

\* Lumen nominali LED max a 25° | Nominal lumen at max 25°  
 \*\* Potenza dei LED | LED power  
 \*\*\* Flusso totale in uscita dall'apparecchio a temperatura di lavoro (Ta 25° - 4.000 K) | Total lighting fitting flux output at working temperature (Ta 25° - 4.000 K) | (3.000 K -8% - CRI 90 -10%)

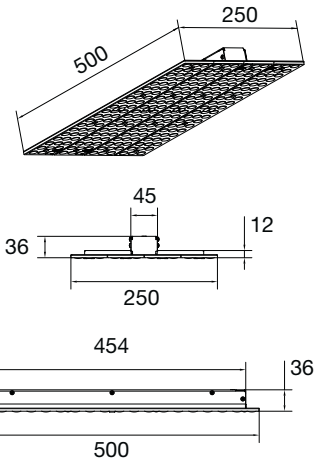

A RICHIESTA | ON REQUEST

>90  
CRI

EM  
EN 60598-2-22

DL  
DALI

PD  
PUSH DIM

WIRELESS



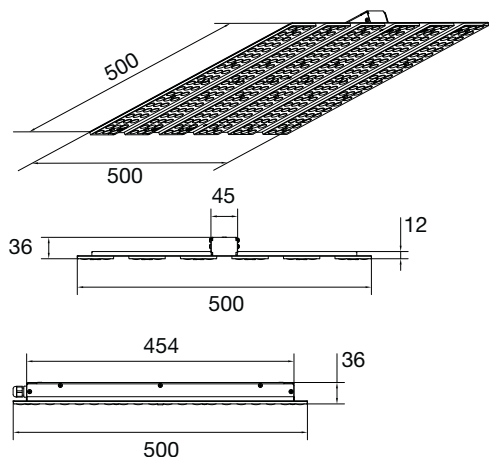

# SOTTILE Q

Sospensione industriale a LED per l'illuminazione di capannoni e di aree commerciali IP43. IP43 LED industrial suspension fitting for lighting warehouses and commercial areas.



A RICHIESTA | ON REQUEST

>90 CRI
EM EN 60598-2-22
DL DALI
PD PUSH DIM
WIRELESS

**5Y WARRANTY**  
5% FAILURE RATE

**60.000 h**  
LED LIFETIME L90B10

**100.000 h**  
LED LIFETIME L70B50

Relamping	Lumen LED*	Watt LED**	Lumen Out***	Watt	Lumen Watt Out	Configurazione LED LED configuration	Codice Code	Lenti Lens	K	Alimentazione Power Supply	Colore Colour
4x55	15150	84	13890	88	> 157		S0256	LA	W: 3.000 N: 4.000 C: 6.000	— : CAE A RICHIESTA   ON REQUEST DL: DALI PD: PUSH DIM	01: bianco white
4x80	20700	123	18974	129	> 146		S0356				
4x55	15150	84	13890	88	> 157		S0256	ST			
4x80	20700	123	18974	129	> 146		S0356				
4x55	15150	84	13890	88	> 157		S0256	HR			
4x80	20700	123	18974	129	> 146		S0356				
4x55	15150	84	13890	88	> 157		S0256	BT			
4x80	20700	123	18974	129	> 146		S0356				

CE
EMC
>80 CRI
IP43 EN 60529
230 V 2014/35/UE
50/60 Hz
IK 07 EN 60068
  
850° EN 60695
A++ A+ A
RG 0 EN 62471
01 WHITE

TEMPERATURA AMBIENTE MIN E MAX | MIN AND MAX ROOM TEMPERATURE: (-10° +40°)

\* Lumen nominali LED max a 25° | Nominal lumen at max 25°  
 \*\* Potenza dei LED | LED power  
 \*\*\* Flusso totale in uscita dall'apparecchio a temperatura di lavoro (Ta 25° - 4.000 K) | Total lighting fitting flux output at working temperature (Ta 25° - 4.000 K) | (3.000 K -8% - CRI 90 -10%)



Design innovativo e tecnologia illuminotecnica LED creano INNOVA LIGHT TECHNICAL SOLUTIONS nuovi apparecchi tecnici IP67 ad elevata efficienza luminosa.

*Innovative design and LED lighting technology create INNOVA LIGHT TECHNICAL SOLUTIONS new technical fixtures IP67 with higher lighting efficiency.*



## PLAFONIERE STAGNE AD ALTA PROTEZIONE MECCANICA HIGH PROTECTION MECHANICAL WATERPROOF FIXTURE

Sistema di apparecchi illuminotecnici LED per l'industria e il terziario.  
*LED lighting fixtures system for industries and services.*



IT

**INTRO**

La gamma più ampia e completa di apparecchi stagni IP67D. Apparecchi illuminanti appositamente progettati per l'utilizzo della tecnologia LED per impianti ad elevata efficienza energetica. Corpo unico in policarbonato coestruso. Comfort visivo. Struttura interna in alluminio per un'elevata dissipazione del calore per garantire la massima durata ed efficienza del LED. Nessuna manutenzione.

La diversa tipologia di schermi e gruppi ottici rende INNOVA utilizzabile negli ambienti industriali e magazzini dove vengono richieste un'elevata efficienza energetica e livelli di sicurezza meccanica elevati. Nel settore alimentare per la sua estrema pulizia e robustezza. Installazione possibile anche a basse e alte temperature. Nel settore terziario in situazioni in cui la manutenzione è difficile e negli ambienti ove le temperature sono elevate.

**LIBERTÀ DI SCELTA TECNICA E DI DESIGN DESIDERATO.****Schermo/diffusore in policarbonato.**

Il policarbonato scelto da IDEALLUX è un policarbonato coestruso autoestingente, resistente ai raggi UV (sistema JEDEX). Policarbonato con ottimo coefficiente di diffusione della luce e di rendimento. Comfort visivo ed efficienza luminosa sono le caratteristiche di tutti gli schermi INNOVA XL. L'esterno liscio del diffusore permette una sua veloce e perfetta pulizia.

EN

**INTRO**

The most wide and complete range of water proof fixtures IP67D. Lighting fixtures designed to use LED technology for high energy-efficient plants. One piece body made of coextruded polycarbonate. Visual comfort. Internal aluminium structure for a higher heat dissipation to guarantee maximum LED service life. No maintenance needed.

Different diffuser types and louver groups enable the application of INNOVA in industrial environments and warehouses, where high energetic efficiency and mechanical safety standards are required. In food industry ideal due to its cleanliness and strength. Installation possible at low temperatures too. In service sector where maintenance is difficult and temperatures are high.

**FREEDOM OF TECHNICAL CHOICE AND DESIGN.****Polycarbonate diffuser.**

Coextruded fireproof UV-resistant (JEDEX system) polycarbonate is chosen by IDEALLUX and it has an excellent coefficient of light diffusion and performance. Characteristics of all INNOVA XL diffusers are visual comfort and lighting efficiency. Smooth external part of the diffuser allows its quick and perfect cleaning.



**CARATTERISTICHE COMUNI ALLA SERIE INNOVA**  
**CHARACTERISTICS COMMON TO THE INNOVA SERIES**



IT

**Eliminazione dei ganci meccanici per l'assemblaggio scocca-diffusore con la costruzione di un unico corpo/diffusore in policarbonato.** Il policarbonato scelto da IDEALLUX è un policarbonato coestruso autoestinguento, resistente ai raggi UV (sistema JEDEX).

EN

**One piece polycarbonate body enables the assembling without mechanical hooks.** Polycarbonate selected by IDEALLUX is coextruded fireproof UV-resistant (JEDEX system).



IT

Struttura interna in alluminio per la massima dissipazione del calore. **Parabola in alluminio speculare progettata per la massima efficienza luminosa del LED installato.** INNOVA non presenta alcuna BLACK SPOT e l'illuminazione è perfettamente uniforme per tutta la lunghezza.

EN

Internal aluminium structure for higher dissipation. **Specular aluminium louver designed for maximum lighting efficiency of the installed LED.** Using INNOVA there are NO BLACK SPOTS. Illumination is perfectly uniform.

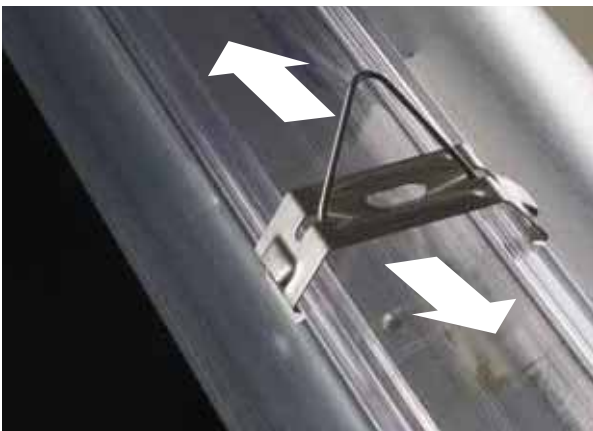

IT

**ATTENZIONE** è possibile utilizzare i punti di fissaggio preesistenti. Le staffe di fissaggio a innesto rapido scorrono su tutto il dorso della lampada.

EN

**NOTICE** it is possible to use existing fixing points. Quick plug-in fixing brackets slide all over the body of the fixture.







# INNOVA XL

IT

## **SCHERMO/DIFFUSORE SATINATO**

Schermo/diffusore in policarbonato satinato. Ottimo comfort visivo con ottimi coefficienti di rendimento luminoso.

## **SCHERMO/DIFFUSORE OPALE**

Schermo/diffusore in policarbonato opale. Controllo visivo della sorgente LED. Tipologia di schermo utilizzata nelle situazioni in cui l'estetica dello schermo opale e l'uniformità della luce viene richiesta. Idonea per uffici e zone di transito.

EN

## **SATIN DIFFUSER**

Satin polycarbonate diffuser. Excellent visual comfort with excellent lighting efficiency coefficient.

## **OPAL DIFFUSER**

Opal polycarbonate diffuser. Visual control of LED lighting source. Ideal for applications where opal diffuser aesthetics and light uniformity are requested. Suitable for offices and transit zones.

M



# GAMMA PRODOTTI | PRODUCT RANGE

## INNOVA XL (INTENSIVE-DARK-SAHARA +70C°)

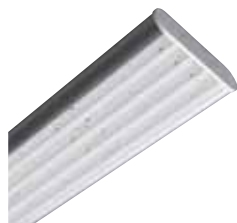

### INNOVA XL (1500-1200-600) SATINATO/SATIN

p. 234-235-236

Corpo unico in policarbonato coestruso satinato ad elevata resistenza meccanica protetto ai raggi UV, a mezzo di coostruzione JEDEX. Riflettore interno in alluminio con funzione di dissipatore. Testate di chiusura in alluminio pressofuso, verniciata con polveri epossidiche previa fosfatazione. Sistema di fissaggio a sospensione. Sorgente luminosa LED. Emissione diretta. Non idonea per applicazioni esterne. Alimentazione elettronica CAE. A richiesta: dimmerabile DALI (cod. DL) specificare se con funzione PUSH DIM (cod. PD).

*One piece body made of coextruded satin polycarbonate with high mechanical resistance UV-resistant (anti UV system named JEDEX). Internal louver with heat sink function. Die-cast aluminium endcaps painted with epoxy powders after phosphating. Suspension fixing system. LED light source. Direct light emission. Not suitable for outdoor application. Built in electronic driver CAE. On request: dimmable DALI (code DL) PUSH DIM function (code PD) to be requested.*



### INNOVA XL (1500-1200) OPALE/OPAL

p. 238-239

Corpo unico in policarbonato coestruso opale ad elevata resistenza meccanica protetto ai raggi UV, a mezzo di coostruzione JEDEX. Riflettore interno in alluminio con funzione di dissipatore. Testate di chiusura in alluminio pressofuso, verniciata con polveri epossidiche previa fosfatazione. Sistema di fissaggio a sospensione. Sorgente luminosa LED. Emissione diretta. Non idonea per applicazioni esterne. Alimentazione elettronica CAE. A richiesta: dimmerabile DALI (cod. DL) specificare se con funzione PUSH DIM (cod. PD).

*One piece body made of coextruded opal polycarbonate with high mechanical resistance UV-resistant (anti UV system named JEDEX). Internal louver with heat sink function. Die-cast aluminium endcaps painted with epoxy powders after phosphating. Suspension fixing system. LED light source. Direct light emission. Not suitable for outdoor application. Built in electronic driver CAE. On request: dimmable DALI (code DL) PUSH DIM function (code PD) to be requested.*



### INNOVA XL INTENSIVE (1500-1200) SATINATO/SATIN

p. 240

Corpo unico in policarbonato coestruso satinato ad elevata resistenza meccanica protetto ai raggi UV, a mezzo di coostruzione JEDEX. Riflettore interno in alluminio con funzione di dissipatore. Ottiche concentranti in policarbonato estruso ad alta efficienza. Testate di chiusura in alluminio pressofuso, verniciata con polveri epossidiche previa fosfatazione. Sistema di fissaggio a plafone o sospensione. Sorgente luminosa LED. Emissione diretta. Non idonea per applicazioni esterne. Alimentazione elettronica CAE. A richiesta: dimmerabile DALI (cod. DL) specificare se con funzione PUSH DIM (cod. PD).

*One piece body made of coextruded opal polycarbonate with high mechanical resistance UV-resistant (anti UV system named JEDEX). Internal louver with heat sink function. High performance extruded polycarbonate optical narrow beam. Die-cast aluminium endcaps painted with epoxy powders after phosphating. Suspension fixing system. LED light source. Direct light emission. Not suitable for outdoor application. Built in electronic driver CAE. On request: dimmable DALI (code DL) PUSH DIM function (code PD) to be requested.*



### INNOVA XL DARK (1500-1200-600) SATINATO/SATIN

p. 241

Corpo unico in policarbonato coestruso satinato ad elevata resistenza meccanica protetto ai raggi UV, a mezzo di coostruzione JEDEX. Riflettore interno in alluminio con funzione di dissipatore. Ottica dark a bassa luminanza idonea per ambienti con videoterminali (inferiore a 1000 cd/m<sup>2</sup> per angoli superiori a 65° trasversali e longitudinali). Testate di chiusura in alluminio pressofuso, verniciata con polveri epossidiche previa fosfatazione. Sistema di fissaggio a plafone o sospensione. Sorgente luminosa LED. Emissione diretta. Non idonea per applicazioni esterne. Alimentazione elettronica CAE. A richiesta: dimmerabile DALI (cod. DL) specificare se con funzione PUSH DIM (cod. PD).

*One piece body made of coextruded opal polycarbonate with high mechanical resistance UV-resistant (anti UV system named JEDEX). Internal louver with heat sink function. Low UGR optic suitable in rooms with VDT (lower than 1000 cd/m<sup>2</sup> for angles >65° transversal and longitudinal). Die-cast aluminium endcaps painted with epoxy powders after phosphating. Suspension fixing system. LED light source. Direct light emission. Not suitable for outdoor application. Built in electronic driver CAE. On request: dimmable DALI (code DL) PUSH DIM function (code PD) to be requested.*

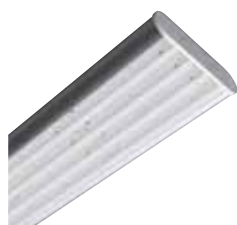

### INNOVA XL SAHARA + 70°C (1500-1200) SATINATO/SATIN

p. 242

Corpo unico in policarbonato coestruso opale ad elevata resistenza meccanica protetto ai raggi UV, a mezzo di coostruzione JEDEX. Riflettore interno in alluminio con funzione di dissipatore. Testate di chiusura in alluminio pressofuso, verniciata con polveri epossidiche previa fosfatazione. Sistema di fissaggio a plafone o sospensione. Sorgente luminosa LED. Emissione diretta. Non idonea per applicazioni esterne. Alimentazione elettronica CAE resistente alle alte temperature. A richiesta: dimmerabile DALI (cod. DL) specificare se con funzione PUSH DIM (cod. PD).

*One piece body made of coextruded satin polycarbonate with high mechanical resistance UV-resistant (anti UV system named JEDEX). Internal louver with heat sink function. Die-cast aluminium endcaps painted with epoxy powders after phosphating. Suspension fixing system. LED light source. Direct light emission. Not suitable for outdoor application. Built in electronic driver CAE. On request: dimmable DALI (code DL) PUSH DIM function (code PD) to be requested.*

# FOTOMETRIE | PHOTOMETRIES

## INNOVA XL (INTENSIVE-DARK-SAHARA +70C°)

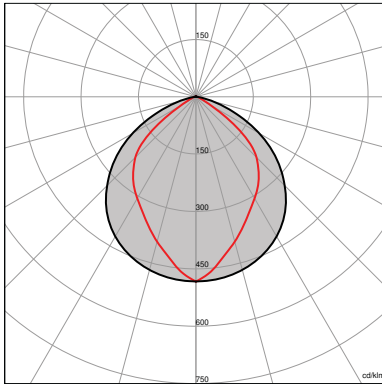

**INNOVA XL**  
SATINATO/SATIN

MG

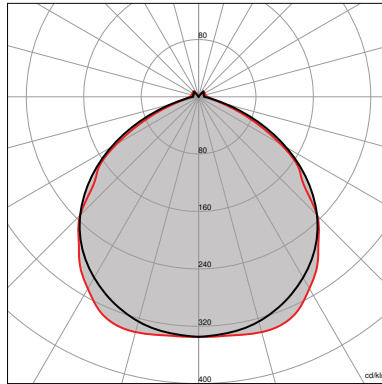

**INNOVA XL**  
SATINATO/SATIN

XP

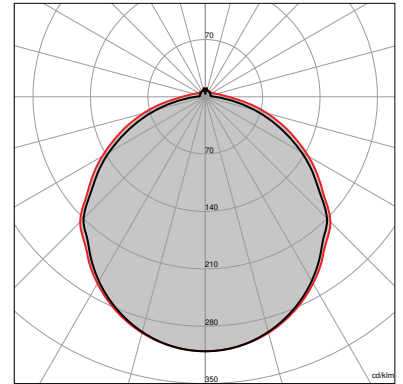

**INNOVA XL**  
OPALE/OPAL

MG

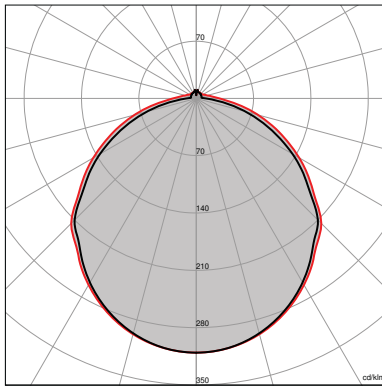

**INNOVA XL**  
OPALE/OPAL

XP

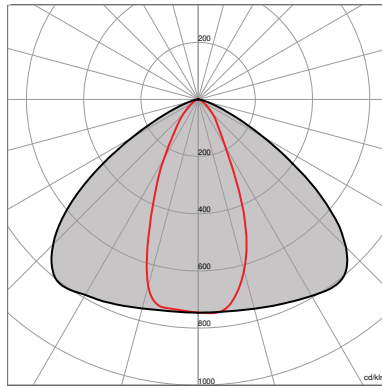

**INNOVA XL INTENSIVE**  
SATINATO/SATIN

LP T TT

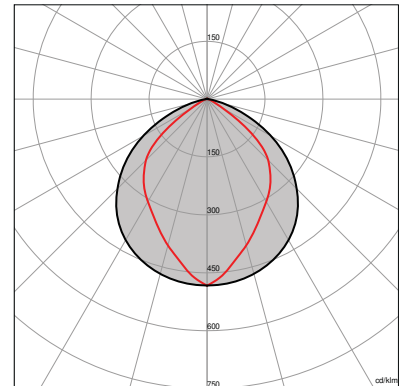

**INNOVA XL DARK**  
SATINATO/SATIN

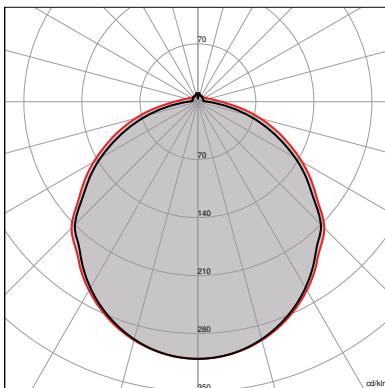

**INNOVA XL SAHARA +70°C**  
SATINATO/SATIN

MG



Rimani aggiornato  
Keep up to date

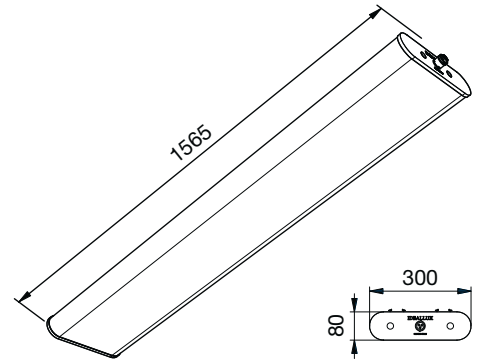

# INNOVA XL 1500

## SATINATO/SATIN



A RICHIESTA | ON REQUEST

<b>5Y WARRANTY</b> 5% FAILURE RATE	<b>60.000 h</b> LED LIFETIME L90B10	<b>100.000 h</b> LED LIFETIME L70B50
---------------------------------------	--	---

>90 CRI	EM EN 60598-2-22	DL DALI	PD PUSH DIM	WIRELESS	
------------	---------------------	------------	----------------	----------	--

Relamping	Lumen LED*	Watt LED**	Lumen Out***	Watt	Lumen Watt Out	Configurazione LED LED configuration	
<b>[L] Lunghezza/Lenght - 1565 mm   Prolungabile/Extendable - 1585 mm</b>							
XP	1XJM400	24000	141	17200	150	> 115	=====
MG	1XJM400	28400	135	20460	144	> 142	=====
XP	1XSAP400	34200	204	24620	218	> 113	=====
MG	1XSAP400	39600	196	28500	206	> 138	=====
MG	1XSAP600	47700	242	34350	258	> 133	=====

Code Code	Cod. Prolungabile Extension Code	K	Alimentazione Power Supply	Schermo Diffuser
INXLXP145	INXLXPP145	W: 3.000 N: 4.000 C: 6.000	A RICHIESTA   ON REQUEST DL: DALI PD: PUSH DIM	satinato satin
INXLMG140	INXLMGP140			
INXLXP200	INXLXPP200			
INXLMG200	INXLMGP200			
INXLMG240	INXLMGP240			

CE		>80 CRI	IP67 EN 60529	230 V 2014/35/UE	50/60 Hz	IK 09 EN 60068	850° EN 60695	A++ A+ A	RG 0 EN 62471	
----	--	------------	------------------	---------------------	-------------	-------------------	------------------	----------------	------------------	--

### INNOVA XL 1500

Presca femmina con pressacavo per alimentazione **inclusa**, lunghezza 54 mm. Accessorio per innesto tubo Ø 20mm **non incluso** vedi accessori.

Female socket with cableglend **included**, lenght 54mm. Joint for rigide conduit Ø 20mm **not included** (see accessories).

### INNOVA XL/P 1500

Apparecchio prolungabile completo di cavo d'alimentazione passante per trasporto d'energia 3x1,5 mm<sup>2</sup>(CAE), 5x1,5mm<sup>2</sup> (DM-DL). **Massima prolungabilità 16m**. Connettori maschio-femmina in testata **inclusi**. Presa volante alimentazione **non inclusa**, spina volante prolungabilità **non inclusa**, tappo terminale **non incluso**, tipologia e codice vedi accessori.

Extendable luminaire complete with power through cable for energy transmission 3x1,5mm<sup>2</sup> (CAE), 5x1,5mm<sup>2</sup> (DM-DL). **Extendable max to 16m**. Male-female connectors on end covers **included**. Female-Male power supply connection socket **not included**, end cover **not included**. For type and code see accessories.

XP | Temperatura ambiente min e max | *Min and max room temperature:*  
**(-20° +40°)**

MG | Temperatura ambiente min e max | *Min and max room temperature:*  
**(-20° +35°)**

\* Lumen nominali LED max a 25° | *Nominal lumen at max 25°*

\*\* Potenza dei LED | *LED power*

\*\*\* Flusso totale in uscita dall'apparecchio a temperatura di lavoro (Ta 25° - 4.000 K).  
*Total lighting fitting flux output at working temperature (Ta 25° - 4.000 K).*  
(3.000 K -8% - CRI 90 -10%).

A RICHIESTA | ON REQUEST

Installazione a plafone / Ceiling installation  
Codice d'ordine | Order Code: **INXL-STP**

Installazione blindo sbarra / Track busway installation  
Codice d'ordine | Order Code: **INXL-STB**

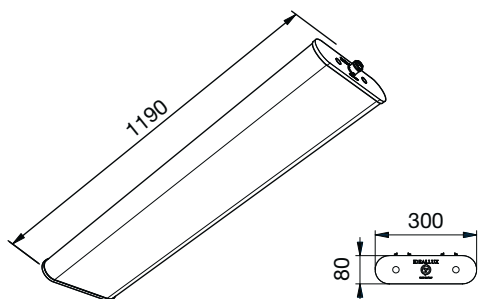

**A RICHIESTA | ON REQUEST**



<b>5Y WARRANTY</b> 5% FAILURE RATE	<b>60.000 h</b> LED LIFETIME L90B10	<b>100.000 h</b> LED LIFETIME L70B50
---------------------------------------	--	---

# INNOVA XL 1200

## SATINATO/SATIN

Relamping	Lumen LED*	Watt LED**	Lumen Out***	Watt	Lumen Watt Out	Configurazione LED LED configuration	Code Code	Cod. Prolungabile Extension Code	K	Alimentazione Power Supply	Schermo Diffuser	
<b>[L] Lunghezza/Lenght - 1190 mm   Prolungabile/Extendable - 1210 mm</b>												
XP	1XJM250	18000	105	12860	112	> 115	=====	INLXP110	INLXPP110	W: 3.000 N: 4.000 C: 6.000	— : CAE A RICHIESTA ON REQUEST DL: DALI PD: PUSH DIM	satinato satin
MG	1XJM250	21320	101,5	15350	108	> 142	=====	INXLMG104	INXLMGP104			
XP	1XSAP250	25650	147	18470	164	> 114	=====	INLXP150	INLXPP150			
MG	1XSAP250	32450	161	23740	172	> 138	=====	INXLMG155	INXLMGP155			
MG	1XJM400	35775	181	25770	193	> 133	=====	INXLMG180	INXLMGP180			



**INNOVA XL 1200**

Presca femmina con pressacavo per alimentazione **inclusa**, lunghezza 54 mm. Accessorio per innesto tubo Ø 20mm **non incluso** vedi accessori.

Female socket with cableglend **included**, lenght 54mm. Joint for rigide conduit Ø 20mm **not included** (see accessories).

**INNOVA XL/P 1200**

Apparecchio prolungabile completo di cavo d'alimentazione passante per trasporto d'energia 3x1,5 mm<sup>2</sup>(CAE), 5x1,5mm<sup>2</sup> (DM-DL). **Massima prolungabilità 16m**. Connettori maschio-femmina in testata **inclusi**. Presa volante alimentazione **non inclusa**, spina volante prolungabilità **non inclusa**, tappo terminale **non incluso**, tipologia e codice vedi accessori.

Extendable luminaire complete with power through cable for energy transmission 3x1,5mm<sup>2</sup> (CAE), 5x1,5mm<sup>2</sup> (DM-DL). **Extendable max to 16m**. Male-female connectors on end covers **included**. Female-Male power supply connection socket **not included**, end cover **not included**. For type and code see accessories.

XP | Temperatura ambiente min e max | *Min and max room temperature:*  
**(-20° +40°)**

MG | Temperatura ambiente min e max | *Min and max room temperature:*  
**(-20° +35°)**

\* Lumen nominali LED max a 25° | *Nominal lumen at max 25°*

\*\* Potenza dei LED | *LED power*

\*\*\* Flusso totale in uscita dall'apparecchio a temperatura di lavoro (Ta 25° - 4.000 K).  
*Total lighting fitting flux output at working temperature (Ta 25° - 4.000 K).*  
(3.000 K -8% - CRI 90 -10%).

**A RICHIESTA | ON REQUEST**

 Installazione a plafone / Ceiling installation  
Codice d'ordine | Order Code: **INXL-STP**

 Installazione blindo sbarra / Track busway installation  
Codice d'ordine | Order Code: **INXL-STB**



Accessori | Accessories  
p. 237



Descrizione prodotto | Product description  
p. 232



Schema di cablaggio | Connection scheme  
p. XXVIII-XXIX



Fotometrie | Photometries  
p. 233

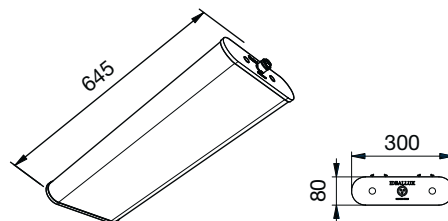

# INNOVA XL 600

## SATINATO/SATIN



A RICHIESTA | ON REQUEST

**5Y WARRANTY**  
5% FAILURE RATE

**60.000 h**  
LED LIFETIME L90B10

**100.000 h**  
LED LIFETIME L70B50

**>90**  
CRI

**EM**  
EN 60598-2-22

DALI

PUSH DIM

WIRELESS

Relamping	Lumen LED*	Watt LED**	Lumen Out***	Watt	Lumen Watt Out	Configurazione LED LED configuration	Codice Code	K	Alimentazione Power Supply	Schermo Diffuser	
<b>[L] Lunghezza/Lenght - 645 mm</b>											
<b>SM</b>	2X28	<b>8200</b>	47	6400	50	> 128	=====	<b>INXLSM56</b>	<b>W:</b> 3.000  <b>N:</b> 4.000  <b>C:</b> 6.000	- : CAE  A RICHIESTA   ON REQUEST <b>DL:</b> DALI <b>PD:</b> PUSH DIM	<b>satinato</b> <i>satín</i>
<b>SM</b>	4X55	<b>12300</b>	70	9600	75	> 128	=====	<b>INXLSM82</b>			
<b>SM</b>	4X55	<b>19200</b>	99	14980	106	> 141	=====	<b>INXLSM94</b>			
<b>SM</b>	4X55 6X55	<b>18420</b>	105	14360	112	> 128	=====	<b>INXLSM112</b>			

CE

**>80**  
CRI

**IP67**  
EN 60529

**230 V**  
2014/35/UE

**50/60**  
Hz

**IK 09**  
EN 60068

**850°**  
EN 60695

**RG 0**  
EN 62471

### INNOVA XL SM 600

Presca femmina con pressacavo per alimentazione **inclusa**, lunghezza 54 mm. Accessorio per innesto tubo Ø 20mm **non incluso** vedi accessori.

Female socket with cableglnd **included**, lenght 54mm. Joint for rigide conduit Ø 20mm **not included** (see accessories).

### INXLSM56-INXLSM82

Temperatura ambiente min e max | *Min and max room temperature:*  
**(-20° +45°)**

### INXLSM94-INXLSM112

Temperatura ambiente min e max | *Min and max room temperature:*  
**(-20° +40°)**

\* Lumen nominali LED max a 25° | *Nominal lumen at max 25°*

\*\* Potenza dei LED | *LED power*

\*\*\* Flusso totale in uscita dall'apparecchio a temperatura di lavoro (Ta 25° - 4.000 K).  
*Total lighting fitting flux output at working temperature (Ta 25° - 4.000 K).*  
 (3.000 K -8% - CRI 90 -10%).

### A RICHIESTA | ON REQUEST

Installazione a plafone / Ceiling installation  
 Codice d'ordine | Order Code: **INXL-STP**

Installazione blindo sbarra / Track busway installation  
 Codice d'ordine | Order Code: **INXL-STB**



	DESCRIZIONE ACCESSORIO   ACCESSORY DESCRIPTION	CODICE   CODE
	<p><b>KIT FUSIBILE 10A</b> Fusibile da utilizzare in testata di alimentazione della linea a protezione del cavo di alimentazione passante (se non protetto diversamente). nella versione prolungabile protezione garantita per max 10 alimentatori.</p> <p><b>FUSE KIT 10A</b> <i>Fuse for feeding cable protection (if not otherwise protected) to be installed on end cover. For extendable version, guaranteed protection for max 10 drivers.</i></p>	<b>IN-KIT-FUSE10A</b>
	<p><b>STAFFE DI FISSAGGIO ANTIVANDOLO</b></p> <p><b>FIXING SPRINGS VANDAL PROOF</b></p>	<b>IN-MOL-AV</b>
	<p><b>ATTACCO CLEAN</b> Per uso alimentare</p> <p><b>CLEAN CONNECTION</b> <i>For feed use</i></p>	<b>IN6002</b> <b>IN12002</b> <b>IN15002</b>
	<p><b>SENSORI INFRAROSSI</b> Kit Infrarossi sensore movimento</p> <p><b>INFRARED SENSOR</b> <i>Infrared Kit motion sensor</i></p>	<b>ININF</b>
	<p><b>SENSORE MICROONDE</b> Kit Micronde sensore movimento</p> <p><b>MICROWAVE SENSOR</b> <i>Microwave Kit motion sensor</i></p>	<b>INMIC</b>
	<p><b>SURGE PROTECTOR</b> Per sistema monofase L 155 mm <i>For a monophase system L 155 mm</i></p>	<b>INSF1</b>
	<p><b>SURGE PROTECTOR</b> Per sistema trifase L 245 mm <i>For a threephase system L 245 mm</i></p>	<b>INSF2</b>
	<p><b>PROLUNGA LUNGHEZZA</b> 300/600/800/1000 mm</p> <p><b>EXTENSION FOR LINE APPLICATIONS</b> <i>300/600/800/1000 mm</i></p>	<b>INHP/P/300</b> <b>INHP/P/600</b> <b>INHP/P/800</b> <b>INHP/P/1000</b>
	<p><b>PRESA FEMMINA</b> Per alimentazione da cablare (da ordinare per INNOVA/P). Lunghezza 54mm.</p> <p><b>FEMALE SOCKET</b> <i>Female socket to be wired (to be ordered for INNOVA/P) Length 54 mm.</i></p>	<b>7PR3702-V</b> (3 poli)
	<p><b>SPINA MASCHIO</b> Per alimentazione da cablare</p> <p><b>MALE PLUG</b> <i>Male plug to be wired</i></p>	<b>7PR5702-V</b> (5 poli)
	<p><b>TERMINALE</b> Chiusura file</p> <p><b>END CAP</b></p>	<b>7PR3701</b> (3 poli)
	<p><b>INNESTO TUBO</b> Ø 20mm</p> <p><b>JOINT FOR RIGIDE CONDUIT</b> <i>Ø 20mm</i></p>	<b>7PR5701</b> (5 poli)
		<b>IN-KIT-TAP</b>
		<b>7PR3700-C</b>

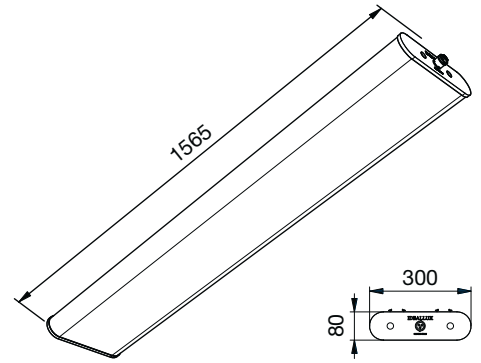

# INNOVA XL 1500

## OPALE/OPAL



A RICHIESTA | ON REQUEST

<b>5Y WARRANTY</b> 5% FAILURE RATE	<b>60.000 h</b> LED LIFETIME L90B10	<b>100.000 h</b> LED LIFETIME L70B50
---------------------------------------	--	---

>90 CRI	EM EN 60598-2-22	DL DALI	PD PUSH DIM	WIRELESS	⚡
------------	---------------------	------------	----------------	----------	---

Relamping	Lumen LED*	Watt LED**	Lumen Out***	Watt	Lumen Watt Out	Configurazione LED LED configuration	Code Code	Cod. Prolungabile Extension Code	K	Alimentazione Power Supply	Schermo Diffuser	
<b>[L] Lunghezza/Lenght - 1565 mm   Prolungabile/Extendable - 1585 mm</b>												
XP	1XJM400	24000	141	16320	150	> 109	=====	INXLXPO145	INXLXPOP145	W: 3.000  N: 4.000  C: 6.000	- : CAE  A RICHIESTA   ON REQUEST DL: DALI PD: PUSH DIM	opale opal
MG	1XJM400	28400	135	19320	144	> 134	=====	INXLMGO140	INXLMGOP140			
XP	1XSAP400	34200	204	23300	218	> 107	=====	INXLXPO200	INXLXPOP200			
MG	1XSAP400	39600	196	26930	206	> 130	=====	INXLMGO200	INXLMGOP200			
MG	1XSAP600	47700	242	32450	258	> 128	=====	INXLMGO240	INXLMGOP240			

CE	⊕	>80 CRI	IP67 EN 60529	230 V 2014/35/UE	50/60 Hz	IK 09 EN 60068	850° EN 60695	A++ A+ A	RG 0 EN 62471	🏠
----	---	------------	------------------	---------------------	-------------	-------------------	------------------	----------------	------------------	---

### INNOVA XL 1500

Presca femmina con pressacavo per alimentazione **inclusa**, lunghezza 54 mm. Accessorio per innesto tubo Ø 20mm **non incluso** vedi accessori.

Female socket with cableglend **included**, lenght 54mm. Joint for rigide conduit Ø 20mm **not included** (see accessories).

### INNOVA XL/P 1500

Apparecchio prolungabile completo di cavo d'alimentazione passante per trasporto d'energia 3x1,5 mm<sup>2</sup>(CAE), 5x1,5mm<sup>2</sup> (DM-DL). **Massima prolungabilità 16m**. Connettori maschio-femmina in testata **inclusi**. Presa volante alimentazione **non inclusa**, spina volante prolungabilità **non inclusa**, tappo terminale **non incluso**, tipologia e codice vedi accessori.

Extendable luminaire complete with power through cable for energy transmission 3x1,5mm<sup>2</sup> (CAE), 5x1,5mm<sup>2</sup> (DM-DL). **Extendable max to 16m**. Male-female connectors on end covers **included**. Female-Male power supply connection socket **not included**, end cover **not included**. For type and code see accessories.

XP | Temperatura ambiente min e max | *Min and max room temperature:*  
**(-20° +40°)**

MG | Temperatura ambiente min e max | *Min and max room temperature:*  
**(-20° +35°)**

\* Lumen nominali LED max a 25° | *Nominal lumen at max 25°*

\*\* Potenza dei LED | *LED power*

\*\*\* Flusso totale in uscita dall'apparecchio a temperatura di lavoro (Ta 25° - 4.000 K).  
*Total lighting fitting flux output at working temperature (Ta 25° - 4.000 K).*  
(3.000 K -8% - CRI 90 -10%).

### A RICHIESTA | ON REQUEST

 Installazione a plafone / Ceiling installation  
Codice d'ordine | Order Code: **INXL-STP**

 Installazione blindo sbarra / Track busway installation  
Codice d'ordine | Order Code: **INXL-STB**

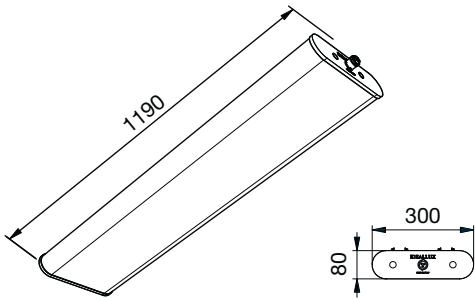

# INNOVA XL 1200

## OPALE/OPAL



**A RICHIESTA | ON REQUEST**



Relamping	Lumen LED*	Watt LED**	Lumen Out***	Watt	Lumen Watt Out	Configurazione LED LED configuration	Code Code	Cod. Prolungabile Extension Code	K	Alimentazione Power Supply	Schermo Diffuser
<b>[L] Lunghezza/Lenght - 1190 mm   Prolungabile/Extendable - 1210 mm</b>											
XP	1XJM400	18000	105	12200	112	> 109	=====	INXLXPO110	INXLXPOP110	W: 3.000 N: 4.000 C: 6.000  A RICHIESTA   ON REQUEST DL: DALI PD: PUSH DIM	opale opal
MG	1XJM400	21320	101,5	14470	108	> 134	=====	INXLMGO104	INXLMGOP104		
XP	1XSAP400	25650	147	17550	164	> 107	=====	INXLXPO150	INXLXPOP150		
MG	1XSAP250	32450	161	22360	172	> 130	=====	INXLMGO155	INXLMGOP155		
MG	1XJM400	35775	181	24700	193	> 128	=====	INXLMGO180	INXLMGOP180		



**INNOVA XL 1200**

Presca femmina con pressacavo per alimentazione **inclusa**, lunghezza 54 mm. Accessorio per innesto tubo Ø 20mm **non incluso** vedi accessori.

Female socket with cableglend **included**, lenght 54mm. Joint for rigide conduit Ø 20mm **not included** (see accessories).

**INNOVA XL/P 1200**

Apparecchio prolungabile completo di cavo d'alimentazione passante per trasporto d'energia 3x1,5 mm<sup>2</sup>(CAE), 5x1,5mm<sup>2</sup> (DM-DL). **Massima prolungabilità 16m**. Connettori maschio-femmina in testata **inclusi**. Presa volante alimentazione **non inclusa**, spina volante prolungabilità **non inclusa**, tappo terminale **non incluso**, tipologia e codice vedi accessori.

Extendable luminaire complete with power through cable for energy transmission 3x1,5mm<sup>2</sup> (CAE), 5x1,5mm<sup>2</sup> (DM-DL). **Extendable max to 16m**. Male-female connectors on end covers **included**. Female-Male power supply connection socket **not included**, end cover **not included**. For type and code see accessories.

XP | Temperatura ambiente min e max | *Min and max room temperature:*  
**(-20° +40°)**

MG | Temperatura ambiente min e max | *Min and max room temperature:*  
**(-20° +35°)**

\* Lumen nominali LED max a 25° | *Nominal lumen at max 25°*

\*\* Potenza dei LED | *LED power*

\*\*\* Flusso totale in uscita dall'apparecchio a temperatura di lavoro (Ta 25° - 4.000 K).  
*Total lighting fitting flux output at working temperature (Ta 25° - 4.000 K).*  
(3.000 K -8% - CRI 90 -10%).

**A RICHIESTA | ON REQUEST**

 Installazione a plafone / Ceiling installation  
Codice d'ordine | Order Code: **INXL-STP**

 Installazione blindo sbarra / Track busway installation  
Codice d'ordine | Order Code: **INXL-STB**

Accessori | Accessories  
p. 243

Descrizione prodotto | Product description  
p. 232

Schema di cablaggio | Connection scheme  
p. XXVIII-XXIX

Fotometrie | Photometries  
p. 233

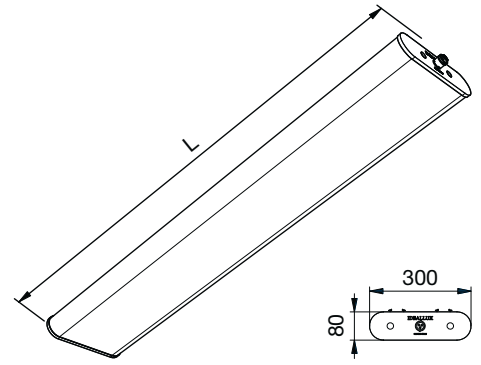

# INNOVA XL INTENSIVE SATINATO/SATIN



A RICHIESTA | ON REQUEST

**5Y WARRANTY**  
5% FAILURE RATE

**60.000 h**  
LED LIFETIME L90B10

**100.000 h**  
LED LIFETIME L70B50

>90  
CRI

EM  
EN 60598-2-22

DL  
DALI

PD  
PUSH DIM

WIRELESS

Relamping	Lumen LED*	Watt LED**	Lumen Out***	Watt	Lumen Watt Out	Configurazione LED LED configuration	Codice Code	K	Alimentazione Power Supply	Schermo Diffuser
<b>[L] Lunghezza/Length - 1565 mm</b>										
LP 4X49 4X58	17230	86	11830	91	> 130	=====	INXLLPI74	W: 3.000	- : CAE  A RICHIESTA   ON REQUEST DL: DALI PD: PUSH DIM	satinato satin
T 6X58	22200	115	15250	123	> 124	=====	INXLTNI110	N: 4.000		
TT 4X80	24000	132	16300	140	> 116	=====	INXLTTI130	C: 6.000		
<b>[L] Lunghezza/Length - 1190 mm</b>										
LP 4X28 4X36	12950	64,5	8800	68	> 130	=====	INXLLPI56	W: 3.000	- : CAE  A RICHIESTA   ON REQUEST DL: DALI PD: PUSH DIM	satinato satin
T 6X36	16600	86	11290	91	> 124	=====	INXLTNI80	N: 4.000		
TT 1XJM150	18000	98	12100	104	> 116	=====	INXLTTI96	C: 6.000		

CE

>80  
CRI

IP67  
EN 60529

230 V  
2014/35/UE

50/60  
Hz

IK 09  
EN 60068

850°  
EN 60695

RG 0  
EN 62471

**INNOVA XL INTENSIVE 1500-1200**

Presa femmina con pressacavo per alimentazione **inclusa**, lunghezza 54 mm. Accessorio per innesto tubo Ø 20mm **non incluso** vedi accessori.

Female socket with cableglend **included**, length 54mm. Joint for rigid conduit Ø 20mm **not included** (see accessories).

**A RICHIESTA | ON REQUEST**

Installazione a plafone / Ceiling installation  
Codice d'ordine | Order Code: **INXL-STP**

Installazione blindo sbarra / Track busway installation  
Codice d'ordine | Order Code: **INXL-STB**

LP | Temperatura ambiente min e max | *Min and max room temperature:*  
**(-20° +45°)**

T | Temperatura ambiente min e max | *Min and max room temperature:*  
**(-20° +40°)**

TT | Temperatura ambiente min e max | *Min and max room temperature:*  
**(-20° +35°)**

\* Lumen nominali LED max a 25° | *Nominal lumen at max 25°*

\*\* Potenza dei LED | *LED power*

\*\*\* Flusso totale in uscita dall'apparecchio a temperatura di lavoro (Ta 25° - 4.000 K).  
*Total lighting fitting flux output at working temperature (Ta 25° - 4.000 K).*  
(3.000 K -8% - CRI 90 -10%).

Fotometrie | *Photometries*  
p. 233

Schema di cablaggio | *Connection scheme*  
p. XXVIII-XXIX

Descrizione prodotto | *Product description*  
p. 232

Accessori | *Accessories*  
p. 243

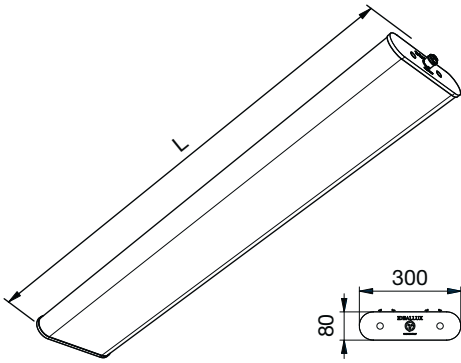

# INNOVA XL DARK SATINATO/SATIN

A RICHIESTA | ON REQUEST



Relamping	Lumen LED*	Watt LED**	Lumen Out***	Watt	Lumen Watt Out	Configurazione LED LED configuration	Codice Code	K	Alimentazione Power Supply	Schermo Diffuser
<b>[L] Lunghezza/Lenght - 1565 mm</b>										
2x49	<b>8620</b>	43	6740	46	> 146	=====	<b>INDK57</b>	W: 3.000	- : CAE  A RICHIESTA   ON REQUEST <b>DL:</b> DALI <b>PD:</b> PUSH DIM	<b>satinato satin</b>
2x58	<b>11100</b>	62	8660	68	> 140	=====	<b>INDK66</b>	N: 4.000  C: 6.000		
<b>[L] Lunghezza/Lenght - 1190 mm</b>										
2x36	<b>6465</b>	32	5037	34,5	> 146	=====	<b>INDK43</b>	W: 3.000	- : CAE  A RICHIESTA   ON REQUEST <b>DL:</b> DALI <b>PD:</b> PUSH DIM	<b>satinato satin</b>
2x58	<b>8300</b>	43	6440	46	> 140	=====	<b>INDK50</b>	N: 4.000  C: 6.000		
<b>[L] Lunghezza/Lenght - 645 mm</b>										
2x18	<b>4240</b>	22	3300	23,5	> 140	=====	<b>INDK24</b>	W: 3.000	- : CAE  A RICHIESTA   ON REQUEST <b>DL:</b> DALI <b>PD:</b> PUSH DIM	<b>satinato satin</b>
4x18	<b>5840</b>	31,5	4550	34	> 134	=====	<b>INDK30</b>	N: 4.000  C: 6.000		



**INNOVA XL DARK 1500-1200-600**

Presse femmina con pressacavo per alimentazione **inclusa**, lunghezza 54 mm. Accessorio per innesto tubo Ø 20mm **non incluso** vedi accessori.

Female socket with cable gland **included**, length 54mm. Joint for rigid conduit Ø 20mm **not included** (see accessories).

**A RICHIESTA | ON REQUEST: INXL-STP - INXL-STB** (vedi | see p. 240)

Temperatura ambiente min e max | *Min and max room temperature:*  
**(-20° +45°)**

\* Lumen nominali LED max a 25° | *Nominal lumen at max 25°*

\*\* Potenza dei LED | *LED power*

\*\*\* Flusso totale in uscita dall'apparecchio a temperatura di lavoro (Ta 25° - 4.000 K).  
*Total lighting fitting flux output at working temperature (Ta 25° - 4.000 K).*  
(3.000 K -8% - CRI 90 -10%).



Accessori | Accessories  
p. 243



Descrizione prodotto | Product description  
p. 232



Schema di cablaggio | Connection scheme  
p. XXVIII-XXIX



Fotometrie | Photometrics  
p. 233

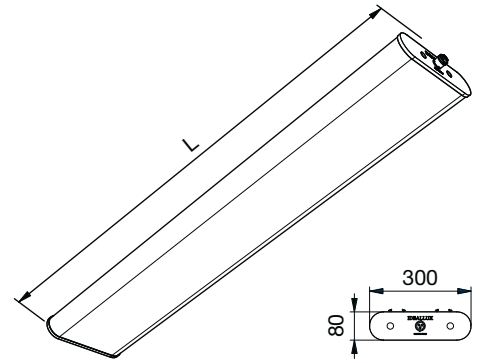

# INNOVA XL SAHARA +70°C SATINATO/SATIN



A RICHIESTA | ON REQUEST

<b>5Y WARRANTY</b> 5% FAILURE RATE	<b>60.000 h</b> LED LIFETIME L90B10	<b>100.000 h</b> LED LIFETIME L70B50
---------------------------------------	--	---

>90 CRI	EM EN 60598-2-22	DL DALI	PD PUSH DIM	WIRELESS	⚡
------------	---------------------	------------	----------------	----------	---

Relamping	Lumen LED*	Watt LED**	Lumen Out***	Watt	Lumen Watt Out	Configurazione LED LED configuration	Codice Code	K	Alimentazione Power Supply	Schermo Diffuser	
<b>[L] Lunghezza/Lenght - 1565 mm</b>											
MG	1XJM400	<b>26240</b>	135	21146	146	> 144	≡	<b>INXLS15</b>	<b>W:</b> 3.000 <b>N:</b> 4.000 <b>C:</b> 6.000	- : CAE  A RICHIESTA   ON REQUEST <b>DL:</b> DALI <b>PD:</b> PUSH DIM	<b>satinato satin</b>
<b>[L] Lunghezza/Lenght - 1190 mm</b>											
MG	1XJM250	<b>19680</b>	97	15750	104	> 151	≡	<b>INXLS12</b>	<b>W:</b> 3.000 <b>N:</b> 4.000 <b>C:</b> 6.000	- : CAE  A RICHIESTA   ON REQUEST <b>DL:</b> DALI <b>PD:</b> PUSH DIM	<b>satinato satin</b>

CE	⊕	>80 CRI	IP67 EN 60529	230 V 2014/35/UE	50/60 Hz	IK 09 EN 60068	850° EN 60695	A++ A+	RG 0 EN 62471	🏠
----	---	------------	------------------	---------------------	-------------	-------------------	------------------	-----------	------------------	---

### INNOVA XL SAHARA 1500-1200

Presca femmina con pressacavo per alimentazione **inclusa**, lunghezza 54 mm. Accessorio per innesto tubo Ø 20mm **non incluso** vedi accessori.

Female socket with cableglad **included**, lenght 54mm. Joint for rigide conduit Ø 20mm **not included** (see accessories).

**MG** | Temperatura ambiente min e max | *Min and max room temperature:*  
**(-20° +70°)**

\* Lumen nominali LED max a 25° | *Nominal lumen at max 25°*

\*\* Potenza dei LED | *LED power*

\*\*\* Flusso totale in uscita dall'apparecchio a temperatura di lavoro (Ta 25° - 4.000 K).  
*Total lighting fitting flux output at working temperature (Ta 25° - 4.000 K).*  
(3.000 K -8% - CRI 90 -10%).

### A RICHIESTA | ON REQUEST

 Installazione a plafone / Ceiling installation  
Codice d'ordine | Order Code: **INXL-STP**

 Installazione blindo sbarra / Track busway installation  
Codice d'ordine | Order Code: **INXL-STB**



Fotometrie | *Photometries*  
p. 233



Schema di cablaggio | *Connection scheme*  
p. XXVIII-XXIX



Descrizione prodotto | *Product description*  
p. 232



Accessori | *Accessories*  
p. 243



	DESCRIZIONE ACCESSORIO   ACCESSORY DESCRIPTION	CODICE   CODE
	<p><b>KIT FUSIBILE 10A</b> Fusibile da utilizzare in testata di alimentazione della linea a protezione del cavo di alimentazione passante (se non protetto diversamente). nella versione prolungabile protezione garantita per max 10 alimentatori.</p> <p><b>FUSE KIT 10A</b> <i>Fuse for feeding cable protection (if not otherwise protected) to be installed on end cover. For extendable version, guaranteed protection for max 10 drivers.</i></p>	<b>IN-KIT-FUSE10A</b>
	<p><b>STAFFE DI FISSAGGIO ANTIVANDOLO</b></p> <p><b>FIXING SPRINGS VANDAL PROOF</b></p>	<b>IN-MOL-AV</b>
	<p><b>ATTACCO CLEAN</b> Per uso alimentare</p> <p><b>CLEAN CONNECTION</b> <i>For feed use</i></p>	<b>IN6002 IN12002 IN15002</b>
	<p><b>SENSORI INFRAROSSI</b> Kit Infrarossi sensore movimento</p> <p><b>INFRARED SENSOR</b> <i>Infrared Kit motion sensor</i></p>	<b>ININF</b>
	<p><b>SENSORE MICROONDE</b> Kit Micronde sensore movimento</p> <p><b>MICROWAVE SENSOR</b> <i>Microwave Kit motion sensor</i></p>	<b>INMIC</b>
	<p><b>SURGE PROTECTOR</b> Per sistema monofase L 155 mm <i>For a monophase system L 155 mm</i></p> <p><b>SURGE PROTECTOR</b> Per sistema trifase L 245 mm <i>For a threephase system L 245 mm</i></p>	<b>INSF1</b>
	<p><b>PROLUNGA LUNGHEZZA</b> 300/600/800/1000 mm</p> <p><b>EXTENSION FOR LINE APPLICATIONS</b> <i>300/600/800/1000 mm</i></p>	<b>INHP/P/300 INHP/P/600 INHP/P/800 INHP/P/1000</b>
	<p><b>PRESA FEMMINA</b> Per alimentazione da cablare (da ordinare per INNOVA/P). Lunghezza 54mm.</p> <p><b>FEMALE SOCKET</b> <i>Female socket to be wired (to be ordered for INNOVA/P) Length 54 mm.</i></p>	<b>7PR3702-V</b> (3 poli)
	<p><b>SPINA MASCHIO</b> Per alimentazione da cablare</p> <p><b>MALE PLUG</b> <i>Male plug to be wired</i></p>	<b>7PR3701</b> (3 poli)
	<p><b>TERMINALE</b> Chiusura file</p> <p><b>END CAP</b></p>	<b>IN-KIT-TAP</b>
	<p><b>INNESTO TUBO</b> Ø 20mm</p> <p><b>JOINT FOR RIGIDE CONDUIT</b> <i>Ø 20mm</i></p>	<b>7PR3700-C</b>



# INNOVA

## IT

### **SCHERMO/DIFFUSORE SATINATO**

Schermo/diffusore in policarbonato satinato. Ottimo comfort visivo con ottimi coefficienti di rendimento luminoso.

### **SCHERMO/DIFFUSORE OPALE**

Schermo/diffusore in policarbonato opale. Controllo visivo della sorgente LED. Tipologia di schermo utilizzata nelle situazioni in cui l'estetica dello schermo opale e l'uniformità della luce viene richiesta. Idonea per uffici e zone di transito.

### **SCHERMO/DIFFUSORE RIGATO**

Schermo/diffusore in policarbonato trasparente. Diffusore extra-trasparente con controllo visivo della sorgente LED tramite la sua strutturazione interna che ne garantisce il comfort visivo.

## EN

### **SATIN DIFFUSER**

Satin polycarbonate diffuser. Excellent visual comfort with excellent lighting efficiency coefficient.

### **OPAL DIFFUSER**

Opal polycarbonate diffuser. Visual control of LED lighting source. Ideal for applications where opal diffuser aesthetics and light uniformity are requested. Suitable for offices and transit zones.

### **RIBBED DIFFUSER**

Transparent polycarbonate diffuser. Extra-transparent diffuser with a visual control of LED lighting source through its internal structuring which guarantees visual comfort.





3000K | 4000K | 5000K

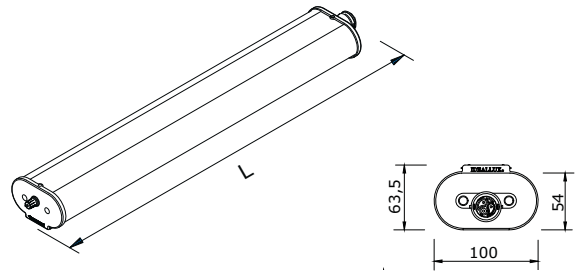

# INNOVA VARIO KELVIN® SATINATO/SATIN

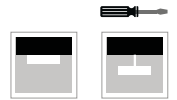

A RICHIESTA | ON REQUEST

<b>5Y WARRANTY</b> 5% FAILURE RATE	<b>60.000 h</b> LED LIFETIME L90B10	<b>100.000 h</b> LED LIFETIME L70B50
---------------------------------------	--	---

>90 CRI	EM EN 60598-2-22	DL DALI	PD PUSH DIM	WIRELESS	⚡
------------	---------------------	------------	----------------	----------	---

Relamping	Lumen LED*	Watt LED**	Lumen Out***	Watt	Lumen Watt Out	Configurazione LED LED configuration	Codice Code	K	Alimentazione Power Supply	Schermo Diffuser
<b>[L] Lunghezza/Lenght - 1580 mm</b>										
2x58	8560	48	6450	51	> 126	—	INXP53VK35	VARIO	— : CAE elettronica <i>electronic</i> <b>DL:</b> DALI (funzione <b>PD****</b> a richiesta/On request)	satinato <i>satın</i>
<b>[L] Lunghezza/Lenght - 1205 mm</b>										
2x36	6450	36	4835	38	> 127	—	INXP40VK35	VARIO	— : CAE elettronica <i>electronic</i> <b>DL:</b> DALI (funzione <b>PD****</b> a richiesta/On request)	satinato <i>satın</i>

CE	⊕	>80 CRI	IP67 EN 60529	230 V 2014/35/UE	50/60 Hz	IK 09 EN 60068	850° EN 60695	A++ A+ A	RG 0 EN 62471	🏠	35 VARIO K
----	---	------------	------------------	---------------------	-------------	-------------------	------------------	----------------	------------------	---	---------------

**INNOVA VARIO KELVIN®**

Presse femmina con pressacavo per alimentazione **inclusa**, lunghezza 54 mm. Accessorio per innesto tubo Ø 20mm **non incluso** vedi accessori.

Female socket with cable gland **included**, length 54mm. Joint for rigid conduit Ø 20mm **not included** (see accessories).

Temperatura ambiente min e max | *Min and max room temperature:*  
**(-20° +40°)**

\* Lumen nominali LED max a 25° | *Nominal lumen at max 25°*

\*\* Potenza dei LED | *LED power*

\*\*\* Flusso totale in uscita dall'apparecchio a temperatura di lavoro (Ta 25° - 4.000 K).  
*Total lighting fitting flux output at working temperature (Ta 25° - 4.000 K).*  
(3.000 K - 8% - CRI 90 -10%).

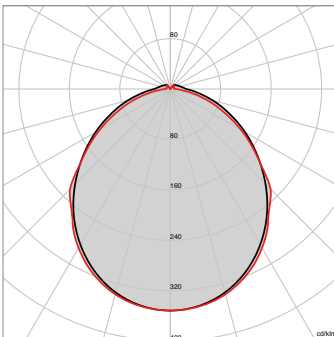

🔌 Schema di cablaggio | *Connection scheme*  
p. XXVIII-XXIX

# VARIO KELVIN®



L'innovativo sistema Vario Kelvin® del Gruppo Raina permette di variare la temperatura di colore degli apparecchi di illuminazione, mediante un selettore opportunamente integrato nel prodotto. La semplicità della tecnologia Vario Kelvin® rende la soluzione accessibile in modo economico a tutta la filiera, contrariamente ad altre tecnologie più costose e complesse. Vario Kelvin® del Gruppo Raina permette con un unico codice prodotto la scelta tra tre diverse temperature di colore: per le applicazioni tecniche residenziali o del retail 2700K, 3350K, 4000K; per gli impianti industriali 3000K, 4000K, 6000K.

The innovative system Vario Kelvin® of Gruppo Raina allows to vary the temperature of colour of the product through an integrated selector. The simplicity of the technology Vario Kelvin® makes the accessible solution in economic way to the whole lighting sector contrarily to other more expensive and complex technologies. Vario Kelvin® of Gruppo Raina allows with an only product code, to choose among three different temperatures of colour: for the residential technical applications or of the retail 2700K, 3350K, 4000K; for the industrial fittings 3000K, 4000K, 6000K.

## CERTIFICAZIONE | CERTIFICATION

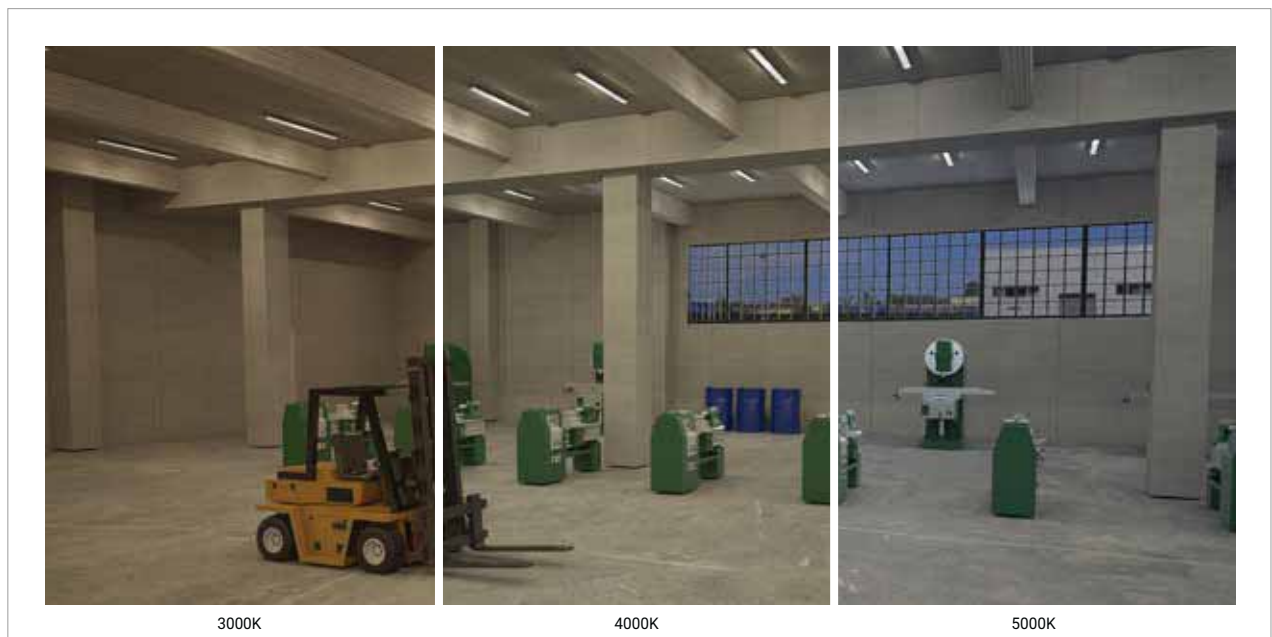

3000K

4000K

5000K

# GAMMA PRODOTTI | PRODUCT RANGE

## INNOVA MEGA



### INNOVA MEGA (1500-1200) SATINATO/SATIN

p. 250-251

Corpo unico in policarbonato coestruso satinato ad elevata resistenza meccanica protetto ai raggi UV, a mezzo di coostruzione JEDEX. Riflettore interno in alluminio con funzione di dissipatore. Testate di chiusura in policarbonato stampato. Sistema di fissaggio a sospensione. Sorgente luminosa LED. Emissione diretta. Non idonea per applicazioni esterne. Alimentazione elettronica CAE. A richiesta: dimmerabile DALI (cod. DL) specificare se con funzione PUSH DIM (cod. PD).

*One piece body made of coextruded satin polycarbonate with high mechanical resistance UV-resistant (anti UV system named JEDEX). Internal louver with heat sink function. Polycarbonate endcaps. Suspension fixing system. LED light source. Direct light emission. Not suitable for outdoor application. Built in electronic driver CAE. On request: dimmable DALI (code DL) PUSH DIM function (code PD) to be requested.*



### INNOVA MEGA (1500-1200) OPALE/OPAL

p. 252-253

Corpo unico in policarbonato coestruso opale ad elevata resistenza meccanica protetto ai raggi UV, a mezzo di coostruzione JEDEX. Riflettore interno in alluminio con funzione di dissipatore. Testate di chiusura in policarbonato stampato. Sistema di fissaggio a sospensione. Sorgente luminosa LED. Emissione diretta. Non idonea per applicazioni esterne. Alimentazione elettronica CAE. A richiesta: dimmerabile DALI (cod. DL) specificare se con funzione PUSH DIM (cod. PD).

*One piece body made of coextruded opal polycarbonate with high mechanical resistance UV-resistant (anti UV system named JEDEX). Internal louver with heat sink function. Polycarbonate endcaps. Suspension fixing system. LED light source. Direct light emission. Not suitable for outdoor application. Built in electronic driver CAE. On request: dimmable DALI (code DL) PUSH DIM function (code PD) to be requested.*



### INNOVA MEGA (1500-1200) RIGATO/RIBBED

p. 254-255

Corpo unico in policarbonato coestruso rigato ad elevata resistenza meccanica protetto ai raggi UV, a mezzo di coostruzione JEDEX. Riflettore interno in alluminio con funzione di dissipatore. Testate di chiusura in policarbonato stampato. Sistema di fissaggio a sospensione. Sorgente luminosa LED. Emissione diretta. Non idonea per applicazioni esterne. Alimentazione elettronica CAE. A richiesta: dimmerabile DALI (cod. DL) specificare se con funzione PUSH DIM (cod. PD).

*One piece body made of coextruded ribbed polycarbonate with high mechanical resistance UV-resistant (anti UV system named JEDEX). Internal louver with heat sink function. Polycarbonate endcaps. Suspension fixing system. LED light source. Direct light emission. Not suitable for outdoor application. Built in electronic driver CAE. On request: dimmable DALI (code DL) PUSH DIM function (code PD) to be requested.*



# FOTOMETRIE | PHOTOMETRIES

## INNOVA MEGA

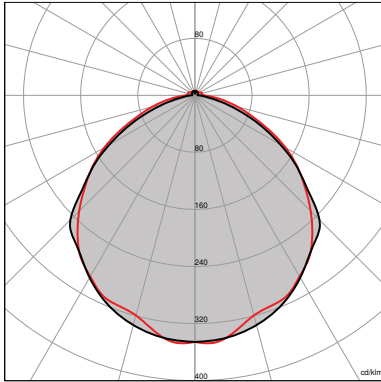

**INNOVA MEGA**  
SATINATO/SATIN

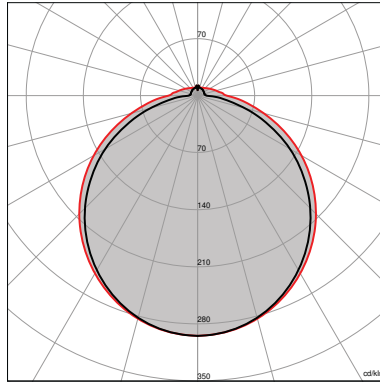

**INNOVA MEGA**  
OPALE/OPAL

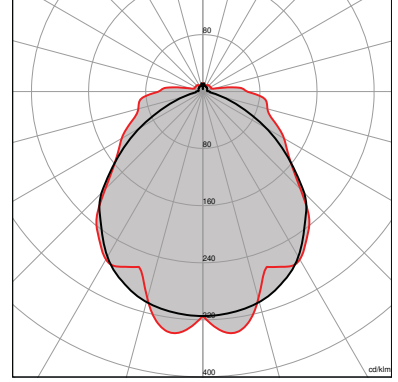

**INNOVA MEGA**  
RIGATO/RIBBED



Rimani aggiornato  
Keep up to date



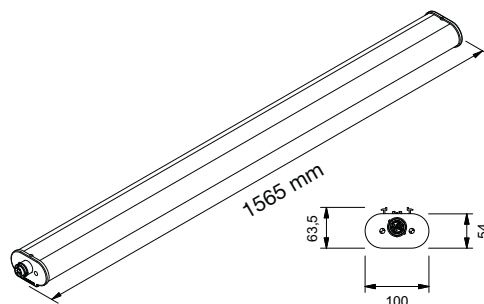

# INNOVA MEGA 1500 SATINATO/SATIN



A RICHIESTA | ON REQUEST

<b>5Y WARRANTY</b> 5% FAILURE RATE	<b>60.000 h</b> LED LIFETIME L90B10	<b>100.000 h</b> LED LIFETIME L70B50
---------------------------------------	--	---

>90 CRI	EM EN 60598-2-22	DL DALI	PD PUSH DIM	WIRELESS	⚡
------------	---------------------	------------	----------------	----------	---

Relamping	Lumen LED*	Watt LED**	Lumen Out***	Watt	Lumen Watt Out	Configurazione LED LED configuration
<b>[L] Lunghezza/Lenght - 1565 mm   Prolungabile/Extendable - 1585 mm</b>						
MG 2x58	9850	48	7085	51	> 138	—
MG 2X49	7100	34	5120	36	> 143	—
MG 1x250	19700	96	14181	102	> 139	==
MG 4X55	14208	67	10280	72	> 142	==

Code Code	Cod. Prolungabile Extension Code	K	Alimentazione Power Supply	Schermo Diffuser
INMG6	INMG6P6	W: 3.000 N: 4.000 C: 6.000	— : CAE A RICHIESTA   ON REQUEST DL: DALI PD: PUSH DIM	satinato satin
INMG4	INMG4P4	W: 3.000 N: 4.000 C: 6.000	— : CAE A RICHIESTA   ON REQUEST DL: DALI PD: PUSH DIM	satinato satin
INMG12	INMG12P12	W: 3.000 N: 4.000 C: 6.000	— : CAE A RICHIESTA   ON REQUEST DL: DALI PD: PUSH DIM	satinato satin
INMG7	INMG7P7	W: 3.000 N: 4.000 C: 6.000	— : CAE A RICHIESTA   ON REQUEST DL: DALI PD: PUSH DIM	satinato satin

CE	⊕	>80 CRI	IP67 EN 60529	230 V 2014/35/UE	50/60 Hz	IK 09 EN 60068	850° EN 60695	A++ A+ A	RG 0 EN 62471	🏠
----	---	------------	------------------	---------------------	-------------	-------------------	------------------	----------------	------------------	---

### INNOVA MEGA 1500

Presca femmina con pressacavo per alimentazione **inclusa**, lunghezza 54 mm. Accessorio per innesto tubo Ø 20mm **non incluso** vedi accessori.

Female socket with cableglend **included**, lenght 54mm. Joint for rigide conduit Ø 20mm **not included** (see accessories).

### INNOVA MEGA/P 1500

Apparecchio prolungabile completo di cavo d'alimentazione passante per trasporto d'energia 3x1,5 mm<sup>2</sup>(CAE), 5x1,5mm<sup>2</sup> (DM-DL). **Massima prolungabilità 16m**. Connettori maschio-femmina in testata **inclusi**. Presca volante alimentazione **non inclusa**, spina volante prolungabilità **non inclusa**, tappo terminale **non incluso**, tipologia e codice vedi accessori.

Extendable luminaire complete with power through cable for energy transmission 3x1,5mm<sup>2</sup> (CAE), 5x1,5mm<sup>2</sup> (DM-DL). **Extendable max to 16m**. Male-female connectors on end covers **included**. Female-Male power supply connection socket **not included**, end cover **not included**. For type and code see accessories.

MG | Temperatura ambiente min e max | Min and max room temperature: **(-20° +35°)**

\* Lumen nominali LED max a 25° | Nominal lumen at max 25°

\*\* Potenza dei LED | LED power

\*\*\* Flusso totale in uscita dall'apparecchio a temperatura di lavoro (Ta 25° - 4.000 K). Total lighting fitting flux output at working temperature (Ta 25° - 4.000 K). (3.000 K -8% - CRI 90 -10%).



Fotometrie | Photometries  
p. 249



Schema di cablaggio | Connection scheme  
p. XXVIII-XXIX



Descrizione prodotto | Product description  
p. 248



Accessori | Accessories  
p. 261

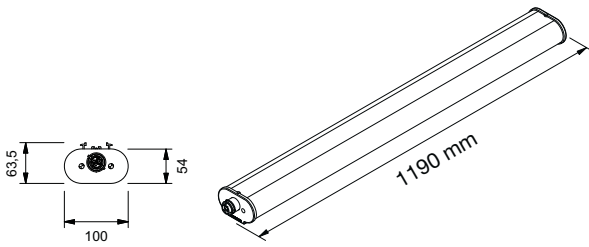

# INNOVA MEGA 1200

## SATINATO/SATIN

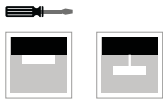

A RICHIESTA | ON REQUEST



<b>5Y WARRANTY</b> 5% FAILURE RATE	<b>60.000 h</b> LED LIFETIME L90B10	<b>100.000 h</b> LED LIFETIME L70B50
---------------------------------------	--	---

Relamping	Lumen LED*	Watt LED**	Lumen Out***	Watt	Lumen Watt Out	Configurazione LED LED configuration	Codice Code	Cod. Prolungabile Extension Code	K	Alimentazione Power Supply	Schermo Diffuser	
<b>[L] Lunghezza/Lenght - 1190 mm   Prolungabile/Extendable - 1210 mm</b>												
MG	2x36	6900	33	4960	36	> 138	—	INMG5	INMGP5	W: 3.000 N: 4.000 C: 6.000	— : CAE  A RICHIESTA   ON REQUEST DL: DALI PD: PUSH DIM	satinato satin
MG	2x28	5330	25	3840	27	> 142	—	INMG2	INMGP2			
MG	4x55	14775	71	10638	76,5	> 139	==	INMG10	INMGP10	W: 3.000 N: 4.000 C: 6.000	— : CAE  A RICHIESTA   ON REQUEST DL: DALI PD: PUSH DIM	satinato satin
MG	2x54	10670	51	7680	54	> 142	==	INMG3	INMGP3			



### INNOVA MEGA 1200

Presca femmina con pressacavo per alimentazione **inclusa**, lunghezza 54 mm. Accessorio per innesto tubo Ø 20mm **non incluso** vedi accessori.

Female socket with cableglad **included**, lenght 54mm. Joint for rigide conduit Ø 20mm **not included** (see accessories).

### INNOVA MEGA/P 1200

Apparecchio prolungabile completo di cavo d'alimentazione passante per trasporto d'energia 3x1,5 mm<sup>2</sup>(CAE), 5x1,5mm<sup>2</sup> (DM-DL). **Massima prolungabilità 16m**. Connettori maschio-femmina in testata **inclusi**. Presca volante alimentazione **non inclusa**, spina volante prolungabilità **non inclusa**, tappo terminale **non incluso**, tipologia e codice vedi accessori.

Extendable luminaire complete with power through cable for energy transmission 3x1,5mm<sup>2</sup> (CAE), 5x1,5mm<sup>2</sup> (DM-DL). **Extendable max to 16m**. Male-female connectors on end covers **included**. Female-Male power supply connection socket **not included**, end cover **not included**. For type and code see accessories.

MG | Temperatura ambiente min e max | Min and max room temperature: **(-20° +35°)**

\* Lumen nominali LED max a 25° | Nominal lumen at max 25°

\*\* Potenza dei LED | LED power

\*\*\* Flusso totale in uscita dall'apparecchio a temperatura di lavoro (Ta 25° - 4.000 K). Total lighting fitting flux output at working temperature (Ta 25° - 4.000 K). (3.000 K -8% - CRI 90 -10%).



Accessori | Accessories  
p. 261



Descrizione prodotto | Product description  
p. 248



Schema di cablaggio | Connection scheme  
p. XXVIII-XXIX



Fotometrie | Photometries  
p. 249

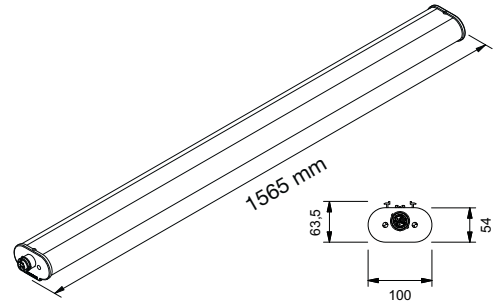

# INNOVA MEGA 1500

## OPALE/OPAL

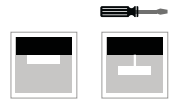

A RICHIESTA | ON REQUEST

<b>5Y WARRANTY</b> 5% FAILURE RATE	<b>60.000 h</b> LED LIFETIME L90B10	<b>100.000 h</b> LED LIFETIME L70B50
---------------------------------------	--	---

>90 CRI	EM EN 60598-2-22	DL DALI	PD PUSH DIM	WIRELESS	⚡
------------	---------------------	------------	----------------	----------	---

Relamping	Lumen LED*	Watt LED**	Lumen Out***	Watt	Lumen Watt Out	Configurazione LED LED configuration
<b>[L] Lunghezza/Lenght - 1565 mm   Prolungabile/Extendable - 1585 mm</b>						
MG 2x58	9850	48	6620	51	> 131	—
MG 2X49	7100	34	4830	36	> 134	—
MG 1x250	19700	96	13400	102	> 131	==
MG 4X55	14208	67	9650	72	> 134	==

Code Code	Cod. Prolungabile Extension Code	K	Alimentazione Power Supply	Schermo Diffuser
INMGO6	INMGOP6	W: 3.000 N: 4.000 C: 6.000	— : CAE A RICHIESTA   ON REQUEST DL: DALI PD: PUSH DIM	opal opal
INMGO4	INMGOP			
INMGO12	INMGOP2	W: 3.000 N: 4.000 C: 6.000	— : CAE A RICHIESTA   ON REQUEST DL: DALI PD: PUSH DIM	opal opal
INMGO7	INMGOP7			

CE	⊕	>80 CRI	IP67 EN 60529	230 V 2014/35/UE	50/60 Hz	IK 09 EN 60068	850° EN 60695	A++ A+	RG 0 EN 62471	🏠
----	---	------------	------------------	---------------------	-------------	-------------------	------------------	-----------	------------------	---

### INNOVA MEGA 1500

Presca femmina con pressacavo per alimentazione **inclusa**, lunghezza 54 mm. Accessorio per innesto tubo Ø 20mm **non incluso** vedi accessori.

Female socket with cableglend **included**, lenght 54mm. Joint for rigide conduit Ø 20mm **not included** (see accessories).

### INNOVA MEGA/P 1500

Apparecchio prolungabile completo di cavo d'alimentazione passante per trasporto d'energia 3x1,5 mm<sup>2</sup>(CAE), 5x1,5mm<sup>2</sup> (DM-DL). **Massima prolungabilità 16m**. Connettori maschio-femmina in testata **inclusi**. Presca volante alimentazione **non inclusa**, spina volante prolungabilità **non inclusa**, tappo terminale **non incluso**, tipologia e codice vedi accessori.

Extendable luminaire complete with power through cable for energy transmission 3x1,5mm<sup>2</sup> (CAE), 5x1,5mm<sup>2</sup> (DM-DL). **Extendable max to 16m**. Male-female connectors on end covers **included**. Female-Male power supply connection socket **not included**, end cover **not included**. For type and code see accessories.

MG | Temperatura ambiente min e max | Min and max room temperature: **(-20° +35°)**

\* Lumen nominali LED max a 25° | Nominal lumen at max 25°

\*\* Potenza dei LED | LED power

\*\*\* Flusso totale in uscita dall'apparecchio a temperatura di lavoro (Ta 25° - 4.000 K). Total lighting fitting flux output at working temperature (Ta 25° - 4.000 K). (3.000 K -8% - CRI 90 -10%).



Fotometrie | Photometrics  
p. 249



Schema di cablaggio | Connection scheme  
p. XXVIII-XXIX



Descrizione prodotto | Product description  
p. 248



Accessori | Accessories  
p. 261

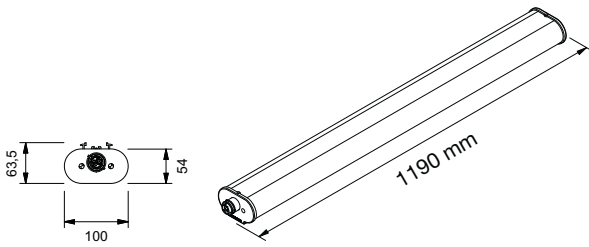

# INNOVA MEGA 1200

## OPALE/OPAL

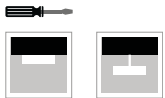

A RICHIESTA | ON REQUEST



<b>5Y WARRANTY</b> 5% FAILURE RATE	<b>60.000 h</b> LED LIFETIME L90B10	<b>100.000 h</b> LED LIFETIME L70B50
---------------------------------------	--	---

Relamping	Lumen LED*	Watt LED**	Lumen Out***	Watt	Lumen Watt Out	Configurazione LED LED configuration	Code Code	Cod. Prolungabile Extension Code	K	Alimentazione Power Supply	Schermo Diffuser	
<b>[L] Lunghezza/Lenght - 1190 mm   Prolungabile/Extendable - 1210 mm</b>												
MG	2x36	<b>6900</b>	33	4960	36	> 138	—	INMG05	INMG0P5	W: 3.000 N: 4.000 C: 6.000	— : CAE  A RICHIESTA   ON REQUEST DL: DALI PD: PUSH DIM	opal opal
MG	2x28	<b>5330</b>	25	3840	27	> 142	—	INMG02	INMG0P			
MG	4x55	<b>14775</b>	71	10638	76,5	> 139	==	INMG010	INMG0P10	W: 3.000 N: 4.000 C: 6.000	— : CAE  A RICHIESTA   ON REQUEST DL: DALI PD: PUSH DIM	opal opal
MG	2x54	<b>10670</b>	51	7680	54	> 142	==	INMG03	INMG0P3			



### INNOVA MEGA 1200

Presca femmina con pressacavo per alimentazione **inclusa**, lunghezza 54 mm. Accessorio per innesto tubo Ø 20mm **non incluso** vedi accessori.

Female socket with cableglad **included**, lenght 54mm. Joint for rigide conduit Ø 20mm **not included** (see accessories).

### INNOVA MEGA/P 1200

Apparecchio prolungabile completo di cavo d'alimentazione passante per trasporto d'energia 3x1,5 mm<sup>2</sup>(CAE), 5x1,5mm<sup>2</sup> (DM-DL). **Massima prolungabilità 16m**. Connettori maschio-femmina in testata **inclusi**. Presca volante alimentazione **non inclusa**, spina volante prolungabilità **non inclusa**, tappo terminale **non incluso**, tipologia e codice vedi accessori.

Extendable luminaire complete with power through cable for energy transmission 3x1,5mm<sup>2</sup> (CAE), 5x1,5mm<sup>2</sup> (DM-DL). **Extendable max to 16m**. Male-female connectors on end covers **included**. Female-Male power supply connection socket **not included**, end cover **not included**. For type and code see accessories.

MG | Temperatura ambiente min e max | Min and max room temperature: **(-20° +35°)**

\* Lumen nominali LED max a 25° | Nominal lumen at max 25°

\*\* Potenza dei LED | LED power

\*\*\* Flusso totale in uscita dall'apparecchio a temperatura di lavoro (Ta 25° - 4.000 K). Total lighting fitting flux output at working temperature (Ta 25° - 4.000 K). (3.000 K -8% - CRI 90 -10%).



Accessori | Accessories  
p. 261



Descrizione prodotto | Product description  
p. 248



Schema di cablaggio | Connection scheme  
p. XXVIII-XXIX



Fotometrie | Photometries  
p. 249

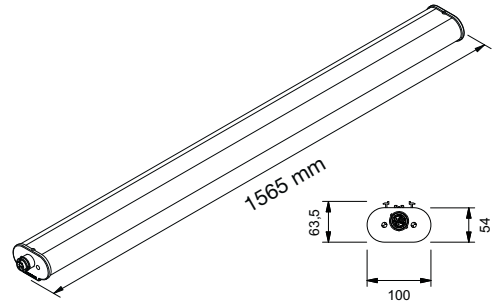

# INNOVA MEGA 1500

## RIGATO/RIBBED



A RICHIESTA | ON REQUEST

<b>5Y WARRANTY</b> 5% FAILURE RATE	<b>60.000 h</b> LED LIFETIME L90B10	<b>100.000 h</b> LED LIFETIME L70B50
---------------------------------------	--	---

>90 CRI	EM EN 60598-2-22	DL DALI	PD PUSH DIM	WIRELESS	⚡
------------	---------------------	------------	----------------	----------	---

Relamping	Lumen LED*	Watt LED**	Lumen Out***	Watt	Lumen Watt Out	Configurazione LED LED configuration	Code Code	Cod. Prolungabile Extension Code	K	Alimentazione Power Supply	Schermo Diffuser	
<b>[L] Lunghezza/Lenght - 1565 mm   Prolungabile/Extendable - 1585 mm</b>												
MG	2x58	9850	48	7085	51	> 138	—	INMGR6	INMGR6	W: 3.000 N: 4.000 C: 6.000	— : CAE A RICHIESTA   ON REQUEST DL: DALI PD: PUSH DIM	rigato ribbed
MG	2X49	7100	34	5120	36	> 143	—	INMGR4	INMGR4			
MG	1x250	19700	96	14181	102	> 139	==	INMGR12	INMGR12	W: 3.000 N: 4.000 C: 6.000	— : CAE A RICHIESTA   ON REQUEST DL: DALI PD: PUSH DIM	rigato ribbed
MG	4X55	14208	67	10280	72	> 142	==	INMGR7	INMGR7			

CE	⊕	>80 CRI	IP67 EN 60529	230 V 2014/35/UE	50/60 Hz	IK 09 EN 60068	850° EN 60695	A++ A+ A	RG 0 EN 62471	🏠
----	---	------------	------------------	---------------------	-------------	-------------------	------------------	----------------	------------------	---

### INNOVA MEGA 1500

Presca femmina con pressacavo per alimentazione **inclusa**, lunghezza 54 mm. Accessorio per innesto tubo Ø 20mm **non incluso** vedi accessori.

Female socket with cableglend **included**, lenght 54mm. Joint for rigide conduit Ø 20mm **not included** (see accessories).

### INNOVA MEGA/P 1500

Apparecchio prolungabile completo di cavo d'alimentazione passante per trasporto d'energia 3x1,5 mm<sup>2</sup>(CAE), 5x1,5mm<sup>2</sup> (DM-DL). **Massima prolungabilità 16m**. Connettori maschio-femmina in testata **inclusi**. Presca volante alimentazione **non inclusa**, spina volante prolungabilità **non inclusa**, tappo terminale **non incluso**, tipologia e codice vedi accessori.

Extendable luminaire complete with power through cable for energy transmission 3x1,5mm<sup>2</sup> (CAE), 5x1,5mm<sup>2</sup> (DM-DL). **Extendable max to 16m**. Male-female connectors on end covers **included**. Female-Male power supply connection socket **not included**, end cover **not included**. For type and code see accessories.

MG | Temperatura ambiente min e max | *Min and max room temperature:*  
**(-20° +35°)**

\* Lumen nominali LED max a 25° | *Nominal lumen at max 25°*

\*\* Potenza dei LED | *LED power*

\*\*\* Flusso totale in uscita dall'apparecchio a temperatura di lavoro (Ta 25° - 4.000 K).  
*Total lighting fitting flux output at working temperature (Ta 25° - 4.000 K).*  
(3.000 K -8% - CRI 90 -10%).



Fotometrie | *Photometries*  
p. 249



Schema di cablaggio | *Connection scheme*  
p. XXVIII-XXIX



Descrizione prodotto | *Product description*  
p. 248



Accessori | *Accessories*  
p. 261



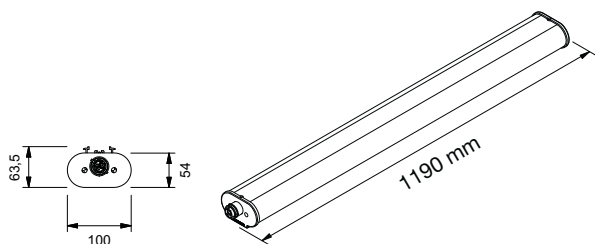

# INNOVA MEGA 1200

## RIGATO/RIBBED



A RICHIESTA | ON REQUEST



Relamping	Lumen LED*	Watt LED**	Lumen Out***	Watt	Lumen Watt Out	Configurazione LED LED configuration	Codice Code	Cod. Prolungabile Extension Code	K	Alimentazione Power Supply	Schermo Diffuser	
<b>[L] Lunghezza/Lenght - 1190 mm   Prolungabile/Extendable - 1210 mm</b>												
MG	2x36	6900	33	4960	36	> 138	—	INMGR5	INMGR5	W: 3.000 N: 4.000 C: 6.000	— : CAE A RICHIESTA   ON REQUEST DL: DALI PD: PUSH DIM	rigato ribbed
MG	2x28	5330	25	3840	27	> 142	—	INMGR2	INMGR2			
MG	4x55	14775	71	10638	76,5	> 139	==	INMGR10	INMGR10	W: 3.000 N: 4.000 C: 6.000	— : CAE A RICHIESTA   ON REQUEST DL: DALI PD: PUSH DIM	rigato ribbed
MG	2x54	10670	51	7680	54	> 142	==	INMGR3	INMGR3			



### INNOVA MEGA 1200

Presca femmina con pressacavo per alimentazione **inclusa**, lunghezza 54 mm. Accessorio per innesto tubo Ø 20mm **non incluso** vedi accessori.

Female socket with cableglad **included**, lenght 54mm. Joint for rigide conduit Ø 20mm **not included** (see accessories).

### INNOVA MEGA/P 1200

Apparecchio prolungabile completo di cavo d'alimentazione passante per trasporto d'energia 3x1,5 mm<sup>2</sup>(CAE), 5x1,5mm<sup>2</sup> (DM-DL). **Massima prolungabilità 16m**. Connettori maschio-femmina in testata **inclusi**. Presca volante alimentazione **non inclusa**, spina volante prolungabilità **non inclusa**, tappo terminale **non incluso**, tipologia e codice vedi accessori.

Extendable luminaire complete with power through cable for energy transmission 3x1,5mm<sup>2</sup> (CAE), 5x1,5mm<sup>2</sup> (DM-DL). **Extendable max to 16m**. Male-female connectors on end covers **included**. Female-Male power supply connection socket **not included**, end cover **not included**. For type and code see accessories.

MG | Temperatura ambiente min e max | Min and max room temperature: (-20° +35°)

\* Lumen nominali LED max a 25° | Nominal lumen at max 25°

\*\* Potenza dei LED | LED power

\*\*\* Flusso totale in uscita dall'apparecchio a temperatura di lavoro (Ta 25° - 4.000 K). Total lighting fitting flux output at working temperature (Ta 25° - 4.000 K). (3.000 K -8% - CRI 90 -10%).



Accessori | Accessories  
p. 261



Descrizione prodotto | Product description  
p. 248



Schema di cablaggio | Connection scheme  
p. XXVIII-XXIX



Fotometrie | Photometries  
p. 249

# GAMMA PRODOTTI | PRODUCT RANGE

## INNOVA



### INNOVA (1500-1200-600) SATINATO/SATIN

p. 258-259-260

Corpo unico in policarbonato coestruso satinato ad elevata resistenza meccanica protetto ai raggi UV, a mezzo di coostruzione JEDEX. Riflettore interno in alluminio con funzione di dissipatore. Testate di chiusura in policarbonato stampato. Sistema di fissaggio a sospensione. Sorgente luminosa LED. Emissione diretta. Non idonea per applicazioni esterne. Alimentazione elettronica CAE. A richiesta: dimmerabile DALI (cod. DL) specificare se con funzione PUSH DIM (cod. PD).

*One piece body made of coextruded satin polycarbonate with high mechanical resistance UV-resistant (anti UV system named JEDEX). Internal louver with heat sink function. Polycarbonate endcaps. Suspension fixing system. LED light source. Direct light emission. Not suitable for outdoor application. Built in electronic driver CAE. On request: dimmable DALI (code DL) PUSH DIM function (code PD) to be requested.*



### INNOVA (1500-1200-600) OPALE/OPAL

p. 262-263-264

Corpo unico in policarbonato coestruso opale ad elevata resistenza meccanica protetto ai raggi UV, a mezzo di coostruzione JEDEX. Riflettore interno in alluminio con funzione di dissipatore. Testate di chiusura in policarbonato stampato. Sistema di fissaggio a sospensione. Sorgente luminosa LED. Emissione diretta. Non idonea per applicazioni esterne. Alimentazione elettronica CAE. A richiesta: dimmerabile DALI (cod. DL) specificare se con funzione PUSH DIM (cod. PD).

*One piece body made of coextruded opal polycarbonate with high mechanical resistance UV-resistant (anti UV system named JEDEX). Internal louver with heat sink function. Polycarbonate endcaps. Suspension fixing system. LED light source. Direct light emission. Not suitable for outdoor application. Built in electronic driver CAE. On request: dimmable DALI (code DL) PUSH DIM function (code PD) to be requested.*



### INNOVA (1500-1200-600) RIGATO/RIBBED

p. 266-267-268

Corpo unico in policarbonato coestruso rigato ad elevata resistenza meccanica protetto ai raggi UV, a mezzo di coostruzione JEDEX. Riflettore interno in alluminio con funzione di dissipatore. Testate di chiusura in policarbonato stampato. Sistema di fissaggio a sospensione. Sorgente luminosa LED. Emissione diretta. Non idonea per applicazioni esterne. Alimentazione elettronica CAE. A richiesta: dimmerabile DALI (cod. DL) specificare se con funzione PUSH DIM (cod. PD).

*One piece body made of coextruded ribbed polycarbonate with high mechanical resistance UV-resistant (anti UV system named JEDEX). Internal louver with heat sink function. Polycarbonate endcaps. Suspension fixing system. LED light source. Direct light emission. Not suitable for outdoor application. Built in electronic driver CAE. On request: dimmable DALI (code DL) PUSH DIM function (code PD) to be requested.*

# FOTOMETRIE | PHOTOMETRIES

INNOVA

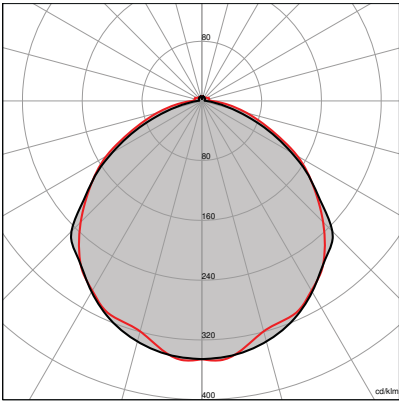

**INNOVA**  
SATINATO/SATIN

LP SP TT T

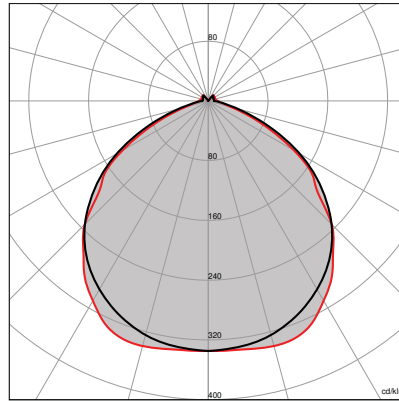

**INNOVA**  
SATINATO/SATIN

XP

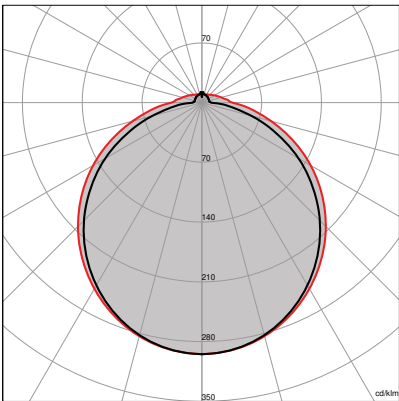

**INNOVA**  
OPALE/OPAL

LP SP TT T

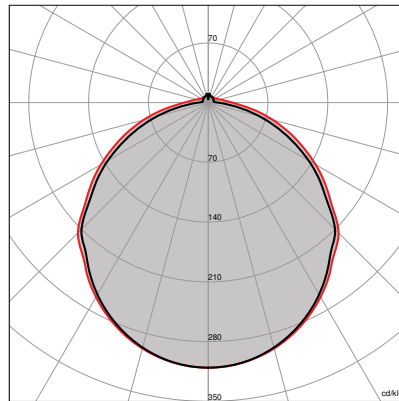

**INNOVA**  
OPALE/OPAL

XP

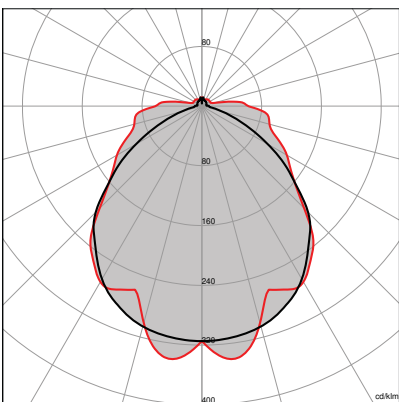

**INNOVA**  
RIGATO/RIBBED

LP SP TT T

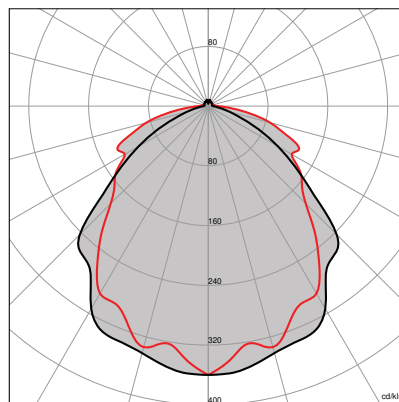

**INNOVA**  
RIGATO/RIBBED

XP



Rimani aggiornato  
Keep up to date

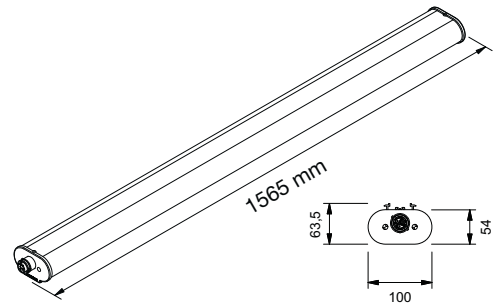

# INNOVA 1500 SATINATO/SATIN



A RICHIESTA | ON REQUEST

<b>5Y WARRANTY</b> 5% FAILURE RATE	<b>60.000 h</b> LED LIFETIME L90B10	<b>100.000 h</b> LED LIFETIME L70B50
---------------------------------------	--	---

>90 CRI	EM EN 60598-2-22	DL DALI	PD PUSH DIM	WIRELESS	⚡
------------	---------------------	------------	----------------	----------	---

Relamping	Lumen LED*	Watt LED**	Lumen Out***	Watt	Lumen Watt Out	Configurazione LED LED configuration	
<b>[L] Lunghezza/Lenght - 1565 mm   Prolungabile/Extendable - 1585 mm</b>							
LP	1X58	<b>4425</b>	20,5	3190	22	> 145	—
SP	1X58	<b>4100</b>	22,5	3280	24	> 137	—
TT	1X80	<b>6024</b>	32	4488	34	> 132	—
T	1X72	<b>4720</b>	24	3588	26	> 138	—
XP	1X58	<b>4100</b>	22,5	3280	24	> 137	—
<b>[P] Lunghezza/Lenght - 1585 mm   Prolungabile/Extendable - 1605 mm</b>							
LP	2x58	<b>8850</b>	40	6380	43	> 148	==
SP	2x58	<b>8170</b>	46	6540	48	> 137	==
TT	2x80	<b>12040</b>	64	9108	69	> 132	==
T	2X72	<b>10800</b>	54	7870	57	> 138	==
XP	2x58	<b>8000</b>	49	6400	51,5	> 124	—

Code Code	Cod. Prolungabile Extension Code	K	Alimentazione Power Supply	Schermo Diffuser
<b>INLP23</b>	<b>INLPP23</b>	W: 3.000 N: 4.000 C: 6.000	— : CAE  A RICHIESTA   ON REQUEST DL: DALI PD: PUSH DIM	<b>satinato satin</b>
<b>INSP27</b>	<b>INSPP27</b>			
<b>INTT36</b>	<b>INTTP36</b>			
<b>INTN34</b>	<b>INTNP34</b>			
<b>INXP27</b>	<b>INXPP27</b>			
<b>INLP43</b>	<b>INLPP43</b>	W: 3.000 N: 4.000 C: 6.000	— : CAE  A RICHIESTA   ON REQUEST DL: DALI PD: PUSH DIM	<b>satinato satin</b>
<b>INSP54</b>	<b>INSPP54</b>			
<b>INTT73</b>	<b>INTTP73</b>			
<b>INTN66</b>	<b>INTNP66</b>			
<b>INXP53</b>	<b>INXPP53</b>			

CE	⊕	>80 CRI	IP67 EN 60529	230 V 2014/35/UE	50/60 Hz	IK 09 EN 60068	850° EN 60695	A++ A+	RG 0 EN 62471	🏠
----	---	------------	------------------	---------------------	-------------	-------------------	------------------	-----------	------------------	---

### INNOVA 1500

Presca femmina con pressacavo per alimentazione **inclusa**, lunghezza 54 mm. Accessorio per innesto tubo Ø 20mm **non incluso** vedi accessori.

Female socket with cableglend **included**, lenght 54mm. Joint for rigide conduit Ø 20mm **not included** (see accessories).

### INNOVA/P 1500

Apparecchio prolungabile completo di cavo d'alimentazione passante per trasporto d'energia 3x1,5 mm<sup>2</sup>(CAE), 5x1,5mm<sup>2</sup> (DM-DL). **Massima prolungabilità 16m**. Connettori maschio-femmina in testata **inclusi**. Presa volante alimentazione **non inclusa**, spina volante prolungabilità **non inclusa**, tappo terminale **non incluso**, tipologia e codice vedi accessori.

Extendable luminaire complete with power through cable for energy transmission 3x1,5mm<sup>2</sup> (CAE), 5x1,5mm<sup>2</sup> (DM-DL). **Extendable max to 16m**. Male-female connectors on end covers **included**. Female-Male power supply connection socket **not included**, end cover **not included**. For type and code see accessories.

**LP** | Temperatura ambiente min e max | *Min and max room temperature:*  
**(-20° +45°)**

**SP-T-XP**  
Temperatura ambiente min e max | *Min and max room temperature:*  
**(-20° +40°)**

**TT** | Temperatura ambiente min e max | *Min and max room temperature:*  
**(-20° +35°)**

\* Lumen nominali LED max a 25° | *Nominal lumen at max 25°*

\*\* Potenza dei LED | *LED power*

\*\*\* Flusso totale in uscita dall'apparecchio a temperatura di lavoro (Ta 25° - 4.000 K).  
*Total lighting fitting flux output at working temperature. (Ta 25° - 4.000 K).*  
(3.000 K -8% - CRI 90 -10%).



Fotometrie | *Photometries*  
p. 257



Schema di cablaggio | *Connection scheme*  
p. XXVIII-XXIX



Descrizione prodotto | *Product description*  
p. 256



Accessori | *Accessories*  
p. 261

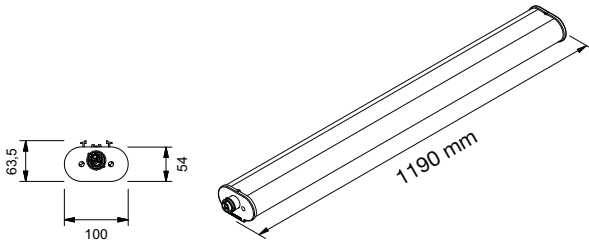

# INNOVA 1200 SATINATO/SATIN

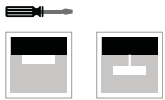

A RICHIESTA | ON REQUEST



<b>5Y WARRANTY</b> 5% FAILURE RATE	<b>60.000 h</b> LED LIFETIME L90B10	<b>100.000 h</b> LED LIFETIME L70B50
---------------------------------------	--	---

Relamping	Lumen LED*	Watt LED**	Lumen Out***	Watt	Lumen Watt Out	Configurazione LED LED configuration	
<b>[L] Lunghezza/Lenght - 1190 mm   Prolungabile/Extendable - 1210 mm</b>							
<b>LP</b>	1x36	<b>3320</b>	15	2390	16,5	> 142	————
<b>SP</b>	1x36	<b>3075</b>	16,5	2460	18	> 137	————
<b>TT</b>	1x58	<b>4515</b>	23,5	3432	26	> 132	————
<b>T</b>	1X49	<b>3540</b>	18	2690	19,5	> 138	————
<b>XP</b>	1x36	<b>3075</b>	16,5	2460	18	> 137	————
<b>[P] Lunghezza/Lenght - 1210 mm   Prolungabile/Extendable - 1230 mm</b>							
<b>LP</b>	2x36	<b>6640</b>	31	4780	33	> 144	=====
<b>SP</b>	2x36	<b>6128</b>	34,5	4905	36	> 137	=====
<b>TT</b>	2x54	<b>9030</b>	48	6864	52	> 132	=====
<b>T</b>	2x49	<b>8100</b>	40,5	5832	42,5	> 137	=====
<b>XP</b>	2x36	<b>6000</b>	36,5	4800	38,5	> 125	=====

Codice Code	Cod. Prolungabile Extension Code	K	Alimentazione Power Supply	Schermo Diffuser
<b>INLP16</b>	<b>INLPP16</b>	W: 3.000 N: 4.000 C: 6.000	— : CAE  A RICHIESTA   ON REQUEST DL: DALI PD: PUSH DIM	<b>satinato satin</b>
<b>INSP21</b>	<b>INSP21</b>			
<b>INTT27</b>	<b>INTTP27</b>			
<b>INTN25</b>	<b>INTNP25</b>			
<b>INXP20</b>	<b>INXPP20</b>			
<b>INLP33</b>	<b>INLPP33</b>	W: 3.000 N: 4.000 C: 6.000	— : CAE  A RICHIESTA   ON REQUEST DL: DALI PD: PUSH DIM	<b>satinato satin</b>
<b>INSP40</b>	<b>INSP40</b>			
<b>INTT54</b>	<b>INTTP54</b>			
<b>INTN50</b>	<b>INTNP50</b>			
<b>INXP40</b>	<b>INXPP40</b>			



### INNOVA 1200

Presca femmina con pressacavo per alimentazione **inclusa**, lunghezza 54 mm. Accessorio per innesto tubo Ø 20mm **non incluso** vedi accessori.

Female socket with cableglend **included**, lenght 54mm. Joint for rigide conduit Ø 20mm **not included** (see accessories).

### INNOVA/P 1200

Apparecchio prolungabile completo di cavo d'alimentazione passante per trasporto d'energia 3x1,5 mm<sup>2</sup>(CAE), 5x1,5mm<sup>2</sup> (DM-DL). **Massima prolungabilità 16m**. Connettori maschio-femmina in testata **inclusi**. Presa volante alimentazione **non inclusa**, spina volante prolungabilità **non inclusa**, tappo terminale **non incluso**, tipologia e codice vedi accessori.

Extendable luminaire complete with power through cable for energy transmission 3x1,5mm<sup>2</sup> (CAE), 5x1,5mm<sup>2</sup> (DM-DL). **Extendable max to 16m**. Male-female connectors on end covers **included**. Female-Male power supply connection socket **not included**, end cover **not included**. For type and code see accessories.

**LP** | Temperatura ambiente min e max | *Min and max room temperature:*  
**(-20° +45°)**

**SP-T-XP**  
Temperatura ambiente min e max | *Min and max room temperature:*  
**(-20° +40°)**

**TT** | Temperatura ambiente min e max | *Min and max room temperature:*  
**(-20° +35°)**

\* Lumen nominali LED max a 25° | *Nominal lumen at max 25°*

\*\* Potenza dei LED | *LED power*

\*\*\* Flusso totale in uscita dall'apparecchio a temperatura di lavoro (Ta 25° - 4.000 K).  
*Total lighting fitting flux output at working temperature. (Ta 25° - 4.000 K).*  
(3.000 K -8% - CRI 90 -10%).

Accessori | Accessories  
p. 261

Descrizione prodotto | Product description  
p. 256

Schema di cablaggio | Connection scheme  
p. XXVIII-XXIX

Fotometrie | Photometries  
p. 257

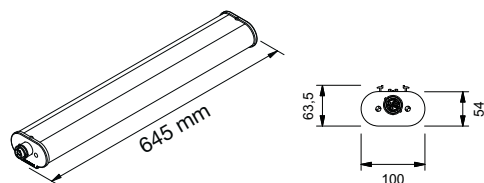

# INNOVA 600

## SATINATO/SATIN



A RICHIESTA | ON REQUEST

**5Y WARRANTY**  
5% FAILURE RATE

**60.000 h**  
LED LIFETIME L90B10

**100.000 h**  
LED LIFETIME L70B50

>90  
CRI

EM  
EN 60598-2-22

DL  
DALI

PD  
PUSH DIM

WIRELESS

Relamping	Lumen LED*	Watt LED**	Lumen Out***	Watt	Lumen Watt Out	Configurazione LED LED configuration	Codice Code	K	Alimentazione Power Supply	Schermo Diffuser	
<b>[L] Lunghezza/Lenght - 645 mm</b>											
XP	1X18	1350	7,2	1.090	8	> 136	—	INXP10	W: 3.000 N: 4.000 C: 6.000	— : CAE A RICHIESTA   ON REQUEST DL: DALI PD: PUSH DIM	satinato satin
SP	1X18	1350	7,2	1.090	8	> 136	—	INSP10			
SP	2X18	2700	14,5	2.180	16	> 119	==	INSP20	W: 3.000 N: 4.000 C: 6.000	— : CAE A RICHIESTA   ON REQUEST DL: DALI PD: PUSH DIM	satinato satin



>80  
CRI

IP67  
EN 60529

230 V  
2014/35/UE

50/60  
Hz

IK 09  
EN 60068

850°  
EN 60695

A++  
A+  
A

RG 0  
EN 62471



### INNOVA 600

Presse femmina con pressacavo per alimentazione **inclusa**, lunghezza 54 mm. Accessorio per innesto tubo Ø 20mm **non incluso** vedi accessori.

Female socket with cableglend **included**, length 54mm. Joint for rigid conduit Ø 20mm **not included** (see accessories).

### SP-XP

Temperatura ambiente min e max | *Min and max room temperature:*  
**(-20° +40°)**

\* Lumen nominali LED max a 25° | *Nominal lumen at max 25°*

\*\* Potenza dei LED | *LED power*

\*\*\* Flusso totale in uscita dall'apparecchio a temperatura di lavoro (Ta 25° - 4.000 K).  
*Total lighting fitting flux output at working temperature (Ta 25° - 4.000 K).*  
(3.000 K -8% - CRI 90 -10%).



Fotometrie | *Photometries*  
p. 257



Schema di cablaggio | *Connection scheme*  
p. XXVIII-XXIX



Descrizione prodotto | *Product description*  
p. 256



Accessori | *Accessories*  
p. 261



	DESCRIZIONE ACCESSORIO   ACCESSORY DESCRIPTION	CODICE   CODE
	<p><b>KIT FUSIBILE 10A</b> Fusibile da utilizzare in testata di alimentazione della linea a protezione del cavo di alimentazione passante (se non protetto diversamente). nella versione prolungabile protezione garantita per max 10 alimentatori.</p> <p><b>FUSE KIT 10A</b> <i>Fuse for feeding cable protection (if not otherwise protected) to be installed on end cover. For extendable version, guaranteed protection for max 10 drivers.</i></p>	<b>IN-KIT-FUSE10A</b>
	<p><b>STAFFE DI FISSAGGIO ANTIVANDOLO</b></p> <p><b>FIXING SPRINGS VANDAL PROOF</b></p>	<b>IN-MOL-AV</b>
	<p><b>ATTACCO CLEAN</b> Per uso alimentare</p> <p><b>CLEAN CONNECTION</b> <i>For feed use</i></p>	<b>IN600 IN1200 IN1500</b>
	<p><b>SENSORI INFRAROSSI</b> Kit Infrarossi sensore movimento</p> <p><b>INFRARED SENSOR</b> <i>Infrared Kit motion sensor</i></p>	<b>ININF</b>
	<p><b>SENSORE MICROONDE</b> Kit Micronde sensore movimento</p> <p><b>MICROWAVE SENSOR</b> <i>Microwave Kit motion sensor</i></p>	<b>INMIC</b>
	<p><b>SURGE PROTECTOR</b> Per sistema monofase L 155 mm <i>For a monophase system L 155 mm</i></p> <p><b>SURGE PROTECTOR</b> Per sistema trifase L 245 mm <i>For a threephase system L 245 mm</i></p>	<b>INSF1</b>
	<p><b>PROLUNGA LUNGHEZZA</b> 300/600/800/1000 mm</p> <p><b>EXTENSION FOR LINE APPLICATIONS</b> <i>300/600/800/1000 mm</i></p>	<b>INHP/P/300 INHP/P/600 INHP/P/800 INHP/P/1000</b>
	<p><b>PRESA FEMMINA</b> Per alimentazione da cablare (da ordinare per INNOVA/P). Lunghezza 54mm.</p> <p><b>FEMALE SOCKET</b> <i>Female socket to be wired (to be ordered for INNOVA/P) Length 54 mm.</i></p>	<b>7PR3702-V</b> (3 poli)  <b>7PR5702-V</b> (5 poli)
	<p><b>SPINA MASCHIO</b> Per alimentazione da cablare</p> <p><b>MALE PLUG</b> <i>Male plug to be wired</i></p>	<b>7PR3701</b> (3 poli)  <b>7PR5701</b> (5 poli)
	<p><b>TERMINALE</b> Chiusura file</p> <p><b>END CAP</b></p>	<b>IN-KIT-TAP</b>
	<p><b>INNESTO TUBO</b> Ø 20mm</p> <p><b>JOINT FOR RIGIDE CONDUIT</b> <i>Ø 20mm</i></p>	<b>7PR3700-C</b>

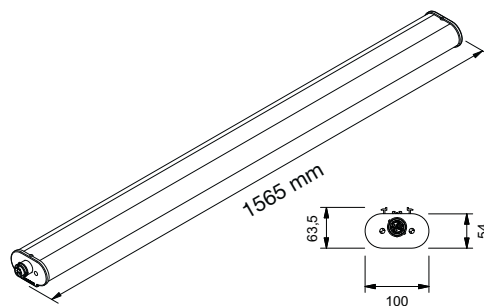

# INNOVA 1500

## OPALE/OPAL



**A RICHIESTA | ON REQUEST**

**5Y WARRANTY**  
5% FAILURE RATE

**60.000 h**  
LED LIFETIME L90B10

**100.000 h**  
LED LIFETIME L70B50

**>90**  
CRI

**EM**  
EN 60590-2:22

DALI

PUSH DIM

WIRELESS

Relamping	Lumen LED*	Watt LED**	Lumen Out***	Watt	Lumen Watt Out	Configurazione LED LED configuration
-----------	------------	------------	--------------	------	----------------	---

**[L] Lunghezza/Lenght - 1565 mm | Prolungabile/Extendable - 1585 mm**

<b>LP</b>	1X58	<b>4425</b>	20,5	3014	22	>137	——
<b>SP</b>	1X58	<b>4100</b>	22,5	3120	24	>130	——
<b>TT</b>	1X80	<b>6024</b>	32	4148	34	>122	——
<b>T</b>	1X72	<b>4720</b>	24	3250	26	>125	——
<b>XP</b>	1X58	<b>4100</b>	22,5	3120	24	>130	——

<b>LP</b>	2x58	<b>8850</b>	40	6020	43	>140	=====
<b>SP</b>	2x58	<b>8170</b>	46	6240	48	>130	=====
<b>TT</b>	2x80	<b>12040</b>	64	8142	69	>118	=====
<b>T</b>	2X72	<b>10800</b>	54	7467	57	>131	=====
<b>XP</b>	2x58	<b>8000</b>	49	6067	51,5	>118	=====

Codice Code	Cod. Prolungabile Extension Code	K	Alimentazione Power Supply	Schermo Diffuser
-------------	-------------------------------------	---	-------------------------------	---------------------

<b>INLPO23</b>	<b>INLPOP23</b>	<b>W:</b> 3.000  <b>N:</b> 4.000  <b>C:</b> 6.000	— : CAE  A RICHIESTA   ON REQUEST <b>DL:</b> DALI <b>PD:</b> PUSH DIM	<b>opale</b> <i>opal</i>
<b>INSPO27</b>	<b>INSPOP27</b>			
<b>INTTO36</b>	<b>INTTOP36</b>			
<b>INTNO34</b>	<b>INTNOP34</b>			
<b>INXPO27</b>	<b>INXPOP27</b>			

<b>INLPO43</b>	<b>INLPOP43</b>	<b>W:</b> 3.000  <b>N:</b> 4.000  <b>C:</b> 6.000	— : CAE  A RICHIESTA   ON REQUEST <b>DL:</b> DALI <b>PD:</b> PUSH DIM	<b>opale</b> <i>opal</i>
<b>INSPO54</b>	<b>INSPOP54</b>			
<b>INTTO73</b>	<b>INTTOP73</b>			
<b>INTNO66</b>	<b>INTNOP66</b>			
<b>INXPO53</b>	<b>INXPOP53</b>			

CE

**>80**  
CRI

**IP67**  
EN 60529

**230 V**  
2014/35/UE

**50/60**  
Hz

**IK 09**  
EN 60068

**850°**  
EN 60695

**RG 0**  
EN 62471

### INNOVA 1500

Presca femmina con pressacavo per alimentazione **inclusa**, lunghezza 54 mm. Accessorio per innesto tubo Ø 20mm **non incluso** vedi accessori.

Female socket with cableglend **included**, lenght 54mm. Joint for rigide conduit Ø 20mm **not included** (see accessories).

### INNOVA/P 1500

Apparecchio prolungabile completo di cavo d'alimentazione passante per trasporto d'energia 3x1,5 mm<sup>2</sup>(CAE), 5x1,5mm<sup>2</sup> (DM-DL). **Massima prolungabilità 16m**. Connettori maschio-femmina in testata **inclusi**. Presa volante alimentazione **non inclusa**, spina volante prolungabilità **non inclusa**, tappo terminale **non incluso**, tipologia e codice vedi accessori.

Extendable luminaire complete with power through cable for energy transmission 3x1,5mm<sup>2</sup> (CAE), 5x1,5mm<sup>2</sup> (DM-DL). **Extendable max to 16m**. Male-female connectors on end covers **included**. Female-Male power supply connection socket **not included**, end cover **not included**. For type and code see accessories.

**LP** | Temperatura ambiente min e max | *Min and max room temperature:*  
**(-20° +45°)**

**SP-T-XP**  
Temperatura ambiente min e max | *Min and max room temperature:*  
**(-20° +40°)**

**TT** | Temperatura ambiente min e max | *Min and max room temperature:*  
**(-20° +35°)**

\* Lumen nominali LED max a 25° | *Nominal lumen at max 25°*

\*\* Potenza dei LED | *LED power*

\*\*\* Flusso totale in uscita dall'apparecchio a temperatura di lavoro (Ta 25° - 4.000 K).  
*Total lighting fitting flux output at working temperature. (Ta 25° - 4.000 K).*  
(3.000 K -8% - CRI 90 -10%).



Fotometrie | *Photometries*  
p. 257



Schema di cablaggio | *Connection scheme*  
p. XXVIII-XXIX



Descrizione prodotto | *Product description*  
p. 256



Accessori | *Accessories*  
p. 265

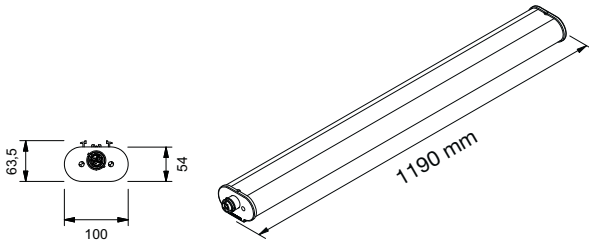

# INNOVA 1200 OPALE/OPAL

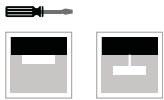

A RICHIESTA | ON REQUEST



<b>5Y WARRANTY</b> 5% FAILURE RATE	<b>60.000 h</b> LED LIFETIME L90B10	<b>100.000 h</b> LED LIFETIME L70B50
---------------------------------------	--	---

Relamping	Lumen LED*	Watt LED**	Lumen Out***	Watt	Lumen Watt Out	Configurazione LED LED configuration
<b>[L] Lunghezza/Lenght - 1190 mm   Prolungabile/Extendable - 1210 mm</b>						
LP	1x36	<b>3320</b>	15	2260	16,5	>137
SP	1x36	<b>3075</b>	16,5	2340	18	>130
TT	1x58	<b>4515</b>	23,5	3172	26	>122
T	1x49	<b>3540</b>	18	2437	19,5	>125
XP	1x36	<b>3075</b>	16,5	2340	18	>130
LP	2x36	<b>6640</b>	31	4620	33	>140
SP	2x36	<b>6128</b>	34,5	4680	36	>130
TT	2x54	<b>9030</b>	48	6136	52	>118
T	2x49	<b>8100</b>	40,5	5567	42,5	>131
XP	2x36	<b>6000</b>	36,5	4543	38,5	>118

Codice Code	Cod. Prolungabile Extension Code	K	Alimentazione Power Supply	Schermo Diffuser
INLP016	INLPOP16	W: 3.000 N: 4.000 C: 6.000	- : CAE A RICHIESTA   ON REQUEST DL: DALI PD: PUSH DIM	opale opal
INSP021	INSPOP21			
INTT027	INTTOP27			
INTN025	INTNOP25			
INXP020	INXPOP20			
INLP033	INLPOP33	W: 3.000 N: 4.000 C: 6.000	- : CAE A RICHIESTA   ON REQUEST DL: DALI PD: PUSH DIM	opale opal
INSP040	INSPOP40			
INTT054	INTTOP54			
INTN050	INTNOP50			
INXP040	INXPOP40			



### INNOVA 1200

Presca femmina con pressacavo per alimentazione **inclusa**, lunghezza 54 mm. Accessorio per innesto tubo Ø 20mm **non incluso** vedi accessori.

Female socket with cableglend **included**, lenght 54mm. Joint for rigide conduit Ø 20mm **not included** (see accessories).

### INNOVA/P 1200

Apparecchio prolungabile completo di cavo d'alimentazione passante per trasporto d'energia 3x1,5 mm<sup>2</sup>(CAE), 5x1,5mm<sup>2</sup> (DM-DL). **Massima prolungabilità 16m**. Connettori maschio-femmina in testata **inclusi**. Presa volante alimentazione **non inclusa**, spina volante prolungabilità **non inclusa**, tappo terminale **non incluso**, tipologia e codice vedi accessori.

Extendable luminaire complete with power through cable for energy transmission 3x1,5mm<sup>2</sup> (CAE), 5x1,5mm<sup>2</sup> (DM-DL). **Extendable max to 16m**. Male-female connectors on end covers **included**. Female-Male power supply connection socket **not included**, end cover **not included**. For type and code see accessories.

LP | Temperatura ambiente min e max | *Min and max room temperature:*  
**(-20° +45°)**

SP-T-XP  
Temperatura ambiente min e max | *Min and max room temperature:*  
**(-20° +40°)**

TT | Temperatura ambiente min e max | *Min and max room temperature:*  
**(-20° +35°)**

\* Lumen nominali LED max a 25° | *Nominal lumen at max 25°*

\*\* Potenza dei LED | *LED power*

\*\*\* Flusso totale in uscita dall'apparecchio a temperatura di lavoro (Ta 25° - 4.000 K).  
*Total lighting fitting flux output at working temperature. (Ta 25° - 4.000 K).*  
(3.000 K -8% - CRI 90 -10%).



Accessori | Accessories  
p. 265



Descrizione prodotto | Product description  
p. 356



Schema di cablaggio | Connection scheme  
p. XXVIII-XXIX



Fotometrie | Photometries  
p. 257

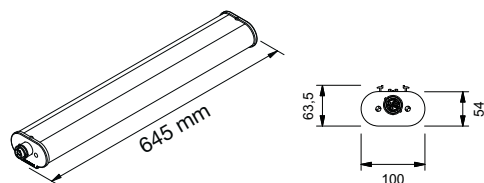

# INNOVA 600

## OPALE/OPAL



A RICHIESTA | ON REQUEST

**5Y WARRANTY**  
5% FAILURE RATE

**60.000 h**  
LED LIFETIME L90B10

**100.000 h**  
LED LIFETIME L70B50

>90  
CRI

EM  
EN 60590-2-22

DL  
DALI

PD  
PUSH DIM

WIRELESS

Relamping	Lumen LED*	Watt LED**	Lumen Out***	Watt	Lumen Watt Out	Configurazione LED LED configuration	Codice Code	K	Alimentazione Power Supply	Schermo Diffuser	
<b>[L] Lunghezza/Lenght - 645 mm</b>											
XP	1X18	1350	7,2	1032	8	> 129	—	INXPO10	W: 3.000 N: 4.000 C: 6.000	— : CAE A RICHIESTA   ON REQUEST DL: DALI PD: PUSH DIM	opale opal
SP	1X18	1350	7,2	1032	8	> 129	—	INSP010			
SP	2X18	2.700	14,5	1808	16	> 113	==	INSP020	W: 3.000 N: 4.000 C: 6.000	— : CAE A RICHIESTA   ON REQUEST DL: DALI PD: PUSH DIM	opale opal



>80  
CRI

IP67  
EN 60529

230 V  
2014/35/UE

50/60  
Hz

IK 09  
EN 60068

850°  
EN 60695

A++  
A+  
A

RG 0  
EN 62471



### INNOVA 600

Presca femmina con pressacavo per alimentazione **inclusa**, lunghezza 54 mm. Accessorio per innesto tubo Ø 20mm **non incluso** vedi accessori.

Female socket with cableglad **included**, length 54mm. Joint for rigid conduit Ø 20mm **not included** (see accessories).

### SP-XP

Temperatura ambiente min e max | *Min and max room temperature:*  
**(-20° +40°)**

\* Lumen nominali LED max a 25° | *Nominal lumen at max 25°*

\*\* Potenza dei LED | *LED power*

\*\*\* Flusso totale in uscita dall'apparecchio a temperatura di lavoro (Ta 25° - 4.000 K).  
*Total lighting fitting flux output at working temperature (Ta 25° - 4.000 K).*  
(3.000 K -8% - CRI 90 -10%).



Fotometrie | *Photometries*  
p. 257



Schema di cablaggio | *Connection scheme*  
p. XXVIII-XXIX



Descrizione prodotto | *Product description*  
p. 256



Accessori | *Accessories*  
p. 257

	DESCRIZIONE ACCESSORIO   ACCESSORY DESCRIPTION	CODICE   CODE
	<p><b>KIT FUSIBILE 10A</b> Fusibile da utilizzare in testata di alimentazione della linea a protezione del cavo di alimentazione passante (se non protetto diversamente). nella versione prolungabile protezione garantita per max 10 alimentatori.</p> <p><b>FUSE KIT 10A</b> <i>Fuse for feeding cable protection (if not otherwise protected) to be installed on end cover. For extendable version, guaranteed protection for max 10 drivers.</i></p>	<b>IN-KIT-FUSE10A</b>
	<p><b>STAFFE DI FISSAGGIO ANTIVANDOLO</b></p> <p><b>FIXING SPRINGS VANDAL PROOF</b></p>	<b>IN-MOL-AV</b>
	<p><b>ATTACCO CLEAN</b> Per uso alimentare</p> <p><b>CLEAN CONNECTION</b> <i>For feed use</i></p>	<b>IN600 IN1200 IN1500</b>
	<p><b>SENSORI INFRAROSSI</b> Kit Infrarossi sensore movimento</p> <p><b>INFRARED SENSOR</b> <i>Infrared Kit motion sensor</i></p>	<b>ININF</b>
	<p><b>SENSORE MICROONDE</b> Kit Micronde sensore movimento</p> <p><b>MICROWAVE SENSOR</b> <i>Microwave Kit motion sensor</i></p>	<b>INMIC</b>
	<p><b>SURGE PROTECTOR</b> Per sistema monofase L 155 mm <i>For a monophase system L 155 mm</i></p> <p><b>SURGE PROTECTOR</b> Per sistema trifase L 245 mm <i>For a threephase system L 245 mm</i></p>	<b>INSF1</b>
	<p><b>PROLUNGA LUNGHEZZA</b> 300/600/800/1000 mm</p> <p><b>EXTENSION FOR LINE APPLICATIONS</b> <i>300/600/800/1000 mm</i></p>	<b>INHP/P/300 INHP/P/600 INHP/P/800 INHP/P/1000</b>
	<p><b>PRESA FEMMINA</b> Per alimentazione da cablare (da ordinare per INNOVA/P). Lunghezza 54mm.</p> <p><b>FEMALE SOCKET</b> <i>Female socket to be wired (to be ordered for INNOVA/P) Length 54 mm.</i></p>	<b>7PR3702-V</b> (3 poli)
	<p><b>SPINA MASCHIO</b> Per alimentazione da cablare</p> <p><b>MALE PLUG</b> <i>Male plug to be wired</i></p>	<b>7PR3701</b> (3 poli)
	<p><b>TERMINALE</b> Chiusura file</p> <p><b>END CAP</b></p>	<b>IN-KIT-TAP</b>
	<p><b>INNESTO TUBO</b> Ø 20mm</p> <p><b>JOINT FOR RIGIDE CONDUIT</b> <i>Ø 20mm</i></p>	<b>7PR3700-C</b>

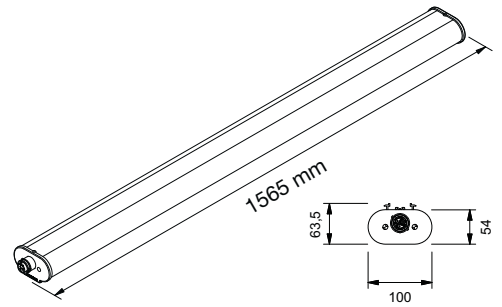

# INNOVA 1500 RIGATO/RIGATO



A RICHIESTA | ON REQUEST

**5Y WARRANTY**  
5% FAILURE RATE

**60.000 h**  
LED LIFETIME L90B10

**100.000 h**  
LED LIFETIME L70B50

**>90**  
CRI

**EM**  
EN 60598-2-22

DALI

PUSH DIM

WIRELESS

Relamping	Lumen LED*	Watt LED**	Lumen Out***	Watt	Lumen Watt Out	Configurazione LED LED configuration	
<b>[L] Lunghezza/Lenght - 1565 mm   Prolungabile/Extendable - 1585 mm</b>							
<b>LP</b>	1X58	<b>4425</b>	20,5	3190	22	> 145	————
<b>SP</b>	1X58	<b>4100</b>	22,5	3280	24	> 137	————
<b>TT</b>	1X80	<b>6024</b>	32	4488	34	> 132	————
<b>T</b>	1X72	<b>4720</b>	24	3588	26	> 138	————
<b>XP</b>	1X58	<b>4100</b>	22,5	3280	24	> 137	————
<b>[R] Lunghezza/Lenght - 1565 mm   Prolungabile/Extendable - 1585 mm</b>							
<b>LP</b>	2x58	<b>8850</b>	40	6380	43	> 148	=====
<b>SP</b>	2x58	<b>8170</b>	46	6540	48	> 137	=====
<b>TT</b>	2x80	<b>12040</b>	64	9108	69	> 132	=====
<b>T</b>	2X72	<b>10800</b>	54	7870	57	> 138	=====
<b>XP</b>	2x58	<b>8000</b>	49	6400	51,5	> 124	————

Code Code	Cod. Prolungabile Extension Code	K	Alimentazione Power Supply	Schermo Diffuser
<b>INLPR23</b>	<b>INLPRP23</b>	W: 3.000 N: 4.000 C: 6.000	— : CAE  A RICHIESTA   ON REQUEST DL: DALI PD: PUSH DIM	<b>rigato</b> <i>ribbed</i>
<b>INSPR27</b>	<b>INSPRP27</b>			
<b>INTTR36</b>	<b>INTTRP36</b>			
<b>INTNR34</b>	<b>INTNRP34</b>			
<b>INXPR27</b>	<b>INXPRP27</b>			
<b>INLPR43</b>	<b>INLPRP43</b>	W: 3.000 N: 4.000 C: 6.000	— : CAE  A RICHIESTA   ON REQUEST DL: DALI PD: PUSH DIM	<b>rigato</b> <i>ribbed</i>
<b>INSPR54</b>	<b>INSPRP54</b>			
<b>INTTR73</b>	<b>INTTRP73</b>			
<b>INTNR66</b>	<b>INTNRP66</b>			
<b>INXPR53</b>	<b>INXPRP53</b>			

CE

**>80**  
CRI

**IP67**  
EN 60529

**230 V**  
2014/35/UE

**50/60**  
Hz

**IK 09**  
EN 60068

**850°**  
EN 60695

**RG 0**  
EN 62471

### INNOVA 1500

Presca femmina con pressacavo per alimentazione **inclusa**, lunghezza 54 mm. Accessorio per innesto tubo Ø 20mm **non incluso** vedi accessori.

Female socket with cableglend **included**, lenght 54mm. Joint for rigide conduit Ø 20mm **not included** (see accessories).

### INNOVA/P 1500

Apparecchio prolungabile completo di cavo d'alimentazione passante per trasporto d'energia 3x1,5 mm<sup>2</sup>(CAE), 5x1,5mm<sup>2</sup> (DM-DL). **Massima prolungabilità 16m**. Connettori maschio-femmina in testata **inclusi**. Presa volante alimentazione **non inclusa**, spina volante prolungabilità **non inclusa**, tappo terminale **non incluso**, tipologia e codice vedi accessori.

Extendable luminaire complete with power through cable for energy transmission 3x1,5mm<sup>2</sup> (CAE), 5x1,5mm<sup>2</sup> (DM-DL). **Extendable max to 16m**. Male-female connectors on end covers **included**. Female-Male power supply connection socket **not included**, end cover **not included**. For type and code see accessories.

**LP** | Temperatura ambiente min e max | *Min and max room temperature:*  
**(-20° +45°)**

**SP-T-XP**  
Temperatura ambiente min e max | *Min and max room temperature:*  
**(-20° +40°)**

**TT** | Temperatura ambiente min e max | *Min and max room temperature:*  
**(-20° +35°)**

\* Lumen nominali LED max a 25° | *Nominal lumen at max 25°*

\*\* Potenza dei LED | *LED power*

\*\*\* Flusso totale in uscita dall'apparecchio a temperatura di lavoro (Ta 25° - 4.000 K).  
*Total lighting fitting flux output at working temperature. (Ta 25° - 4.000 K).*  
(3.000 K -8% - CRI 90 -10%).



Fotometrie | *Photometries*  
p. 257



Schema di cablaggio | *Connection scheme*  
p. XXVIII-XXIX



Descrizione prodotto | *Product description*  
p. 256



Accessori | *Accessories*  
p. 269



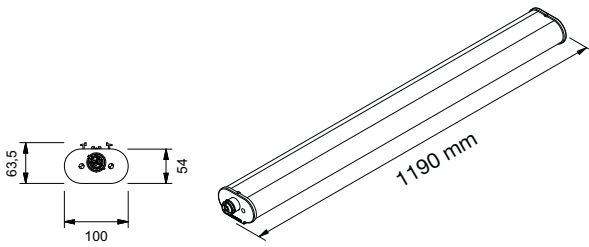

# INNOVA 1200 RIGATO/RIGATO



A RICHIESTA | ON REQUEST



<b>5Y WARRANTY</b> 5% FAILURE RATE	<b>60.000 h</b> LED LIFETIME L90B10	<b>100.000 h</b> LED LIFETIME L70B50
---------------------------------------	--	---

Relamping	Lumen LED*	Watt LED**	Lumen Out***	Watt	Lumen Watt Out	Configurazione LED LED configuration	Codice Code	Cod. Prolungabile Extension Code	K	Alimentazione Power Supply	Schermo Diffuser	
<b>[L] Lunghezza/Lenght - 1190 mm   Prolungabile/Extendable - 1210 mm</b>												
LP	1x36	<b>3320</b>	15	2390	16,5	> 142	————	<b>INLPR16</b>	<b>INLPRP16</b>	<b>W:</b> 3.000  <b>N:</b> 4.000  <b>C:</b> 6.000	— : CAE  A RICHIESTA   ON REQUEST <b>DL:</b> DALI <b>PD:</b> PUSH DIM	<b>rigato ribbed</b>
SP	1x36	<b>3075</b>	16,5	2460	18	> 137	————	<b>INSPR21</b>	<b>INSPRP21</b>			
TT	1x58	<b>4515</b>	23,5	3432	26	> 132	————	<b>INTTR27</b>	<b>INTTRP27</b>			
T	1X49	<b>3540</b>	18	2690	19,5	> 138	————	<b>INTNR25</b>	<b>INTNRP25</b>			
XP	1x36	<b>3075</b>	16,5	2460	18	> 137	————	<b>INXPR20</b>	<b>INXPRP20</b>			
LP	2x36	<b>6640</b>	31	4780	33	> 144	=====	<b>INLPR33</b>	<b>INLPRP33</b>	<b>W:</b> 3.000  <b>N:</b> 4.000  <b>C:</b> 6.000	— : CAE  A RICHIESTA   ON REQUEST <b>DL:</b> DALI <b>PD:</b> PUSH DIM	<b>rigato ribbed</b>
SP	2x36	<b>6128</b>	34,5	4905	36	> 137	=====	<b>INSPR40</b>	<b>INSPRP40</b>			
TT	2x54	<b>9030</b>	48	6864	52	> 132	=====	<b>INTTR54</b>	<b>INTTRP54</b>			
T	2x49	<b>8100</b>	40,5	5832	42,5	> 137	=====	<b>INTNR50</b>	<b>INTNRP50</b>			
XP	2x36	<b>6000</b>	36,5	4800	38,5	> 125	=====	<b>INXPR40</b>	<b>INXPRP40</b>			



### INNOVA 1200

Presca femmina con pressacavo per alimentazione **inclusa**, lunghezza 54 mm. Accessorio per innesto tubo Ø 20mm **non incluso** vedi accessori.

Female socket with cableglend **included**, lenght 54mm. Joint for rigide conduit Ø 20mm **not included** (see accessories).

### INNOVA/P 1200

Apparecchio prolungabile completo di cavo d'alimentazione passante per trasporto d'energia 3x1,5 mm<sup>2</sup>(CAE), 5x1,5mm<sup>2</sup> (DM-DL). **Massima prolungabilità 16m**. Connettori maschio-femmina in testata **inclusi**. Presa volante alimentazione **non inclusa**, spina volante prolungabilità **non inclusa**, tappo terminale **non incluso**, tipologia e codice vedi accessori.

Extendable luminaire complete with power through cable for energy transmission 3x1,5mm<sup>2</sup> (CAE), 5x1,5mm<sup>2</sup> (DM-DL). **Extendable max to 16m**. Male-female connectors on end covers **included**. Female-Male power supply connection socket **not included**, end cover **not included**. For type and code see accessories.

**LP** | Temperatura ambiente min e max | *Min and max room temperature:*  
**(-20° +45°)**

**SP-T-XP**  
Temperatura ambiente min e max | *Min and max room temperature:*  
**(-20° +40°)**

**TT** | Temperatura ambiente min e max | *Min and max room temperature:*  
**(-20° +35°)**

\* Lumen nominali LED max a 25° | *Nominal lumen at max 25°*

\*\* Potenza dei LED | *LED power*

\*\*\* Flusso totale in uscita dall'apparecchio a temperatura di lavoro (Ta 25° - 4.000 K).  
*Total lighting fitting flux output at working temperature. (Ta 25° - 4.000 K).*  
(3.000 K -8% - CRI 90 -10%).



Accessori | Accessories  
p. 269



Descrizione prodotto | Product description  
p. 256



Schema di cablaggio | Connection scheme  
p. XXVIII-XXIX



Fotometrie | Photometries  
p. 257

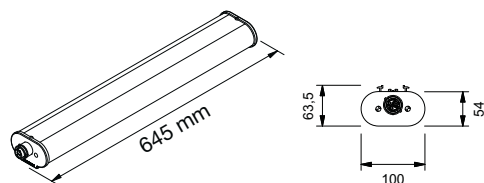

# INNOVA 600

## RIGATO/RIBBED



A RICHIESTA | ON REQUEST

<b>5Y WARRANTY</b> 5% FAILURE RATE	<b>60.000 h</b> LED LIFETIME L90B10	<b>100.000 h</b> LED LIFETIME L70B50
---------------------------------------	--	---

>90 CRI	EM EN 60598-2-22	DL DALI	PD PUSH DIM	WIRELESS	⚡
------------	---------------------	------------	----------------	----------	---

Relamping	Lumen LED*	Watt LED**	Lumen Out***	Watt	Lumen Watt Out	Configurazione LED LED configuration	Codice Code	K	Alimentazione Power Supply	Schermo Diffuser	
<b>[L] Lunghezza/Lenght - 645 mm</b>											
XP	1X18	1350	7,2	1.090	8	> 136	—	INXPR10	W: 3.000 N: 4.000 C: 6.000	— : CAE A RICHIESTA   ON REQUEST DL: DALI PD: PUSH DIM	rigato ribbed
SP	1X18	1350	7,2	1.090	8	> 136	—	INSPR10			
SP	2X18	2700	14,5	2.180	16	> 119	==	INSPR20	W: 3.000 N: 4.000 C: 6.000	— : CAE A RICHIESTA   ON REQUEST DL: DALI PD: PUSH DIM	rigato ribbed

CE	⊕	>80 CRI	IP67 EN 60529	230 V 2014/35/UE	50/60 Hz	IK 09 EN 60068	850° EN 60695	A++ A+	RG 0 EN 62471	🏠
----	---	------------	------------------	---------------------	-------------	-------------------	------------------	-----------	------------------	---

### INNOVA 600

Presca femmina con pressacavo per alimentazione **inclusa**, lunghezza 54 mm. Accessorio per innesto tubo Ø 20mm **non incluso** vedi accessori.

Female socket with cableglad **included**, length 54mm. Joint for rigide conduit Ø 20mm **not included** (see accessories).

### SP-XP

Temperatura ambiente min e max | *Min and max room temperature:*  
**(-20° +40°)**

\* Lumen nominali LED max a 25° | *Nominal lumen at max 25°*

\*\* Potenza dei LED | *LED power*

\*\*\* Flusso totale in uscita dall'apparecchio a temperatura di lavoro (Ta 25° - 4.000 K).  
*Total lighting fitting flux output at working temperature (Ta 25° - 4.000 K).*  
(3.000 K -8% - CRI 90 -10%).



Fotometrie | *Photometries*  
p. 257



Schema di cablaggio | *Connection scheme*  
p. XXVIII-XXIX



Descrizione prodotto | *Product description*  
p. 256



Accessori | *Accessories*  
p. 269

	DESCRIZIONE ACCESSORIO   ACCESSORY DESCRIPTION	CODICE   CODE
	<p><b>KIT FUSIBILE 10A</b> Fusibile da utilizzare in testata di alimentazione della linea a protezione del cavo di alimentazione passante (se non protetto diversamente). nella versione prolungabile protezione garantita per max 10 alimentatori.</p> <p><b>FUSE KIT 10A</b> <i>Fuse for feeding cable protection (if not otherwise protected) to be installed on end cover. For extendable version, guaranteed protection for max 10 drivers.</i></p>	<b>IN-KIT-FUSE10A</b>
	<p><b>STAFFE DI FISSAGGIO ANTIVANDOLO</b> <b>FIXING SPRINGS VANDAL PROOF</b></p>	<b>IN-MOL-AV</b>
	<p><b>ATTACCO CLEAN</b> Per uso alimentare</p> <p><b>CLEAN CONNECTION</b> <i>For feed use</i></p>	<b>IN600 IN1200 IN1500</b>
	<p><b>SENSORI INFRAROSSI</b> Kit Infrarossi sensore movimento</p> <p><b>INFRARED SENSOR</b> <i>Infrared Kit motion sensor</i></p>	<b>ININF</b>
	<p><b>SENSORE MICROONDE</b> Kit Micronde sensore movimento</p> <p><b>MICROWAVE SENSOR</b> <i>Microwave Kit motion sensor</i></p>	<b>INMIC</b>
	<p><b>SURGE PROTECTOR</b> Per sistema monofase L 155 mm <i>For a monophase system L 155 mm</i></p> <p><b>SURGE PROTECTOR</b> Per sistema trifase L 245 mm <i>For a threephase system L 245 mm</i></p>	<b>INSF1 INSF2</b>
	<p><b>PROLUNGA LUNGHEZZA</b> 300/600/800/1000 mm</p> <p><b>EXTENSION FOR LINE APPLICATIONS</b> <i>300/600/800/1000 mm</i></p>	<b>INHP/P/300 INHP/P/600 INHP/P/800 INHP/P/1000</b>
	<p><b>PRESA FEMMINA</b> Per alimentazione da cablare (da ordinare per INNOVA/P). Lunghezza 54mm.</p> <p><b>FEMALE SOCKET</b> <i>Female socket to be wired (to be ordered for INNOVA/P) Length 54 mm.</i></p>	<b>7PR3702-V (3 poli) 7PR5702-V (5 poli)</b>
	<p><b>SPINA MASCHIO</b> Per alimentazione da cablare</p> <p><b>MALE PLUG</b> <i>Male plug to be wired</i></p>	<b>7PR3701 (3 poli) 7PR5701 (5 poli)</b>
	<p><b>TERMINALE</b> Chiusura file</p> <p><b>END CAP</b></p>	<b>IN-KIT-TAP</b>
	<p><b>INNESTO TUBO</b> Ø 20mm</p> <p><b>JOINT FOR RIGIDE CONDUIT</b> <i>Ø 20mm</i></p>	<b>7PR3700-C</b>

# GAMMA PRODOTTI | PRODUCT RANGE

## INNOVA OTTICHE SPECIALI • INNOVA SPECIAL OPTICS



### INNOVA INTENSIVE (1500-1200) SATINATO/SATIN

p. 272

Corpo unico in policarbonato coestruso satinato ad elevata resistenza meccanica protetto ai raggi UV, a mezzo di coostruzione JEDEX. Riflettore interno in alluminio con funzione di dissipatore. Ottiche concentranti in policarbonato estruso ad alta efficienza. Testate di chiusura in policarbonato stampato. Sistema di fissaggio a plafone o sospensione. Sorgente luminosa LED. Emissione diretta. Non idonea per applicazioni esterne. Alimentazione elettronica CAE. A richiesta: dimmerabile DALI (cod. DL) specificare se con funzione PUSH DIM (cod. PD).

*One piece body made of coextruded opal polycarbonate with high mechanical resistance UV-resistant (anti UV system named JEDEX). Internal louver with heat sink function. High performance extruded polycarbonate optical narrow beam. Polycarbonate endcaps. Suspension fixing system. LED light source. Direct light emission. Not suitable for outdoor application. Built in electronic driver CAE. On request: dimmable DALI (code DL) PUSH DIM function (code PD) to be requested.*



### INNOVA CONCENTRANTE (1500-1200) SATINATO/SATIN

p. 273

Corpo unico in policarbonato coestruso satinato ad elevata resistenza meccanica protetto ai raggi UV, a mezzo di coostruzione JEDEX. Riflettore interno in alluminio concentrante con funzione di dissipatore. Testate di chiusura in policarbonato stampato. Sistema di fissaggio a sospensione. Sorgente luminosa LED. Emissione diretta. Non idonea per applicazioni esterne. Alimentazione elettronica CAE. A richiesta: dimmerabile DALI (cod. DL) specificare se con funzione PUSH DIM (cod. PD).

*One piece body made of coextruded opal polycarbonate with high mechanical resistance UV-resistant (anti UV system named JEDEX). Narrow beam internal louver with heat sink function. Polycarbonate endcaps. Suspension fixing system. LED light source. Direct light emission. Not suitable for outdoor application. Built in electronic driver CAE. On request: dimmable DALI (code DL) PUSH DIM function (code PD) to be requested.*



### INNOVA PARK (1500-1200-600) SATINATO/SATIN

p. 274

Corpo unico in policarbonato coestruso satinato ad elevata resistenza meccanica protetto ai raggi UV, a mezzo di coostruzione JEDEX. Riflettore interno in alluminio doppio asimmetrico con funzione di dissipatore. Testate di chiusura in policarbonato stampato. Sistema di fissaggio a sospensione. Sorgente luminosa LED. Emissione diretta. Non idonea per applicazioni esterne. Alimentazione elettronica CAE. A richiesta: dimmerabile DALI (cod. DL) specificare se con funzione PUSH DIM (cod. PD).

*One piece body made of coextruded opal polycarbonate with high mechanical resistance UV-resistant (anti UV system named JEDEX). High performance double asymmetrical aluminium internal reflector with heat sink function. Polycarbonate endcaps. Suspension fixing system. LED light source. Direct light emission. Not suitable for outdoor application. Built in electronic driver CAE. On request: dimmable DALI (code DL) PUSH DIM function (code PD) to be requested.*



### INNOVA ASIMMETRICA (1500-1200-600) SATINATO/SATIN

p. 275

Corpo unico in policarbonato coestruso satinato ad elevata resistenza meccanica protetto ai raggi UV, a mezzo di coostruzione JEDEX. Riflettore interno in alluminio asimmetrico con funzione di dissipatore. Testate di chiusura in policarbonato stampato. Sistema di fissaggio a sospensione. Sorgente luminosa LED. Emissione diretta. Non idonea per applicazioni esterne. Alimentazione elettronica CAE. A richiesta: dimmerabile DALI (cod. DL) specificare se con funzione PUSH DIM (cod. PD).

*One piece body made of coextruded opal polycarbonate with high mechanical resistance UV-resistant (anti UV system named JEDEX). High performance asymmetrical aluminium internal reflector with heat sink function. Polycarbonate endcaps. Suspension fixing system. LED light source. Direct light emission. Not suitable for outdoor application. Built in electronic driver CAE. On request: dimmable DALI (code DL) PUSH DIM function (code PD) to be requested.*

# FOTOMETRIE | PHOTOMETRIES

INNOVA OTTICHE SPECIALI • INNOVA SPECIAL OPTICS

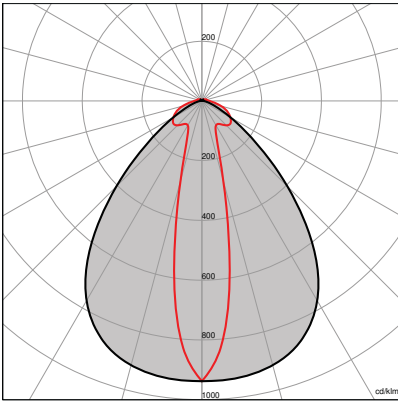

**INNOVA INTENSIVE**  
SATINATO/SATIN

LP T TT

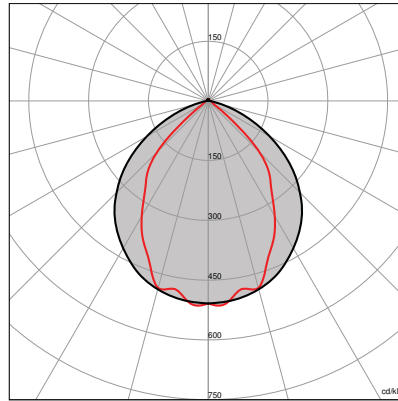

**INNOVA CONCENTRANTE**  
SATINATO/SATIN

SP XP

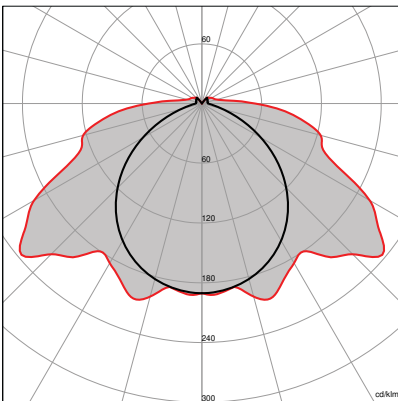

**INNOVA PARK**  
SATINATO/SATIN

LP T TT

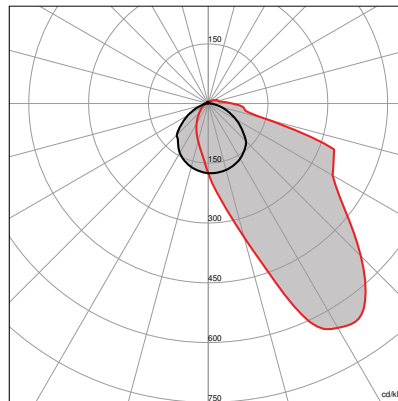

**INNOVA ASIMMETRICA**  
SATINATO/SATIN

SP XP



Rimani aggiornato  
Keep up to date

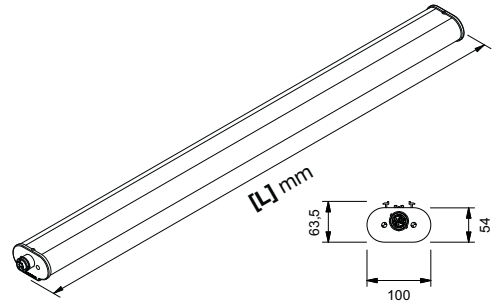

# INNOVA INTENSIVE SATINATO/SATIN

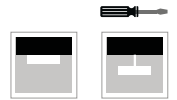

A RICHIESTA | ON REQUEST

<b>5Y WARRANTY</b> 5% FAILURE RATE	<b>60.000 h</b> LED LIFETIME L90B10	<b>100.000 h</b> LED LIFETIME L70B50
---------------------------------------	--	---

>90 CRI	EM EN 60590-2:22	DL DALI	PD PUSH DIM	WIRELESS	⚡
------------	---------------------	------------	----------------	----------	---

Relamping Lumen LED\* Watt LED\*\* Lumen Out\*\*\* Watt Lumen Watt Out Configurazione LED LED configuration

[L] Lunghezza/Lenght - 1565 mm | Prolungabile/Extendable - 1585 mm

LP	1x58	4308	21,5	2991	23	> 127	—
T	1x72	4730	24	3320	27	> 123	—
TT	1x80	6020	32,5	4095	35	> 117	—
LP	2x58	8616	43	5858	46	> 127	===
T	2x72	9460	48	6430	52	> 123	===
TT	2x80	12040	65	8190	70	> 117	===

[L] Lunghezza/Lenght - 1190 mm | Prolungabile/Extendable - 1210 mm

LP	1x28	3230	16	2159	17	> 127	—
T	1x36	3545	18	2398	19,5	> 123	—
TT	1x54	4520	24	3100	26,5	> 117	—
LP	2x28	6460	32	4318	34	> 127	===
T	2x36	7100	36	4670	38	> 124	===
TT	2x54	9030	48	6040	51,5	> 117	===

Codice Code Cod. Prolungabile Extension Code K Alimentazione Power Supply Schermo Diffuser

INIT22	INITP22	N: 4.000 C: 6.000	— : CAE A RICHIESTA   ON REQUEST DL: DALI PD: PUSH DIM	satinato satin
INIT29	INITP29			
INIT34	INITP34			
INIT43	INITP43			
INIT57	INITP57			
INIT66	INITP66			

INI17	INIP17	N: 4.000 C: 6.000	— : CAE A RICHIESTA   ON REQUEST DL: DALI PD: PUSH DIM	satinato satin
INI22	INIP22			
INI25	INIP25			
INI33	INIP33			
INI43	INIP43			
INI50	INIP50			

CE	⊕	>80 CRI	IP67 EN 60529	230 V 2014/35/UE	50/60 Hz	IK 09 EN 60068	850° EN 60695	A++ A+ A	RG 0 EN 62471	🏠
----	---	------------	------------------	---------------------	-------------	-------------------	------------------	----------------	------------------	---

**INNOVA INTENSIVE 1500-1200**  
Plafoniera stagna ideale per l'installazione a 10 mt di altezza. Presa femmina per alimentazione da cablare (7PR3702-V) inclusa, lunghezza 54 mm.

Corrosion-proof LED lighting fittings ideal for 10 mt height installation. Female socket to be wired (7PR3702-V) included, length 54 mm.

**INNOVA/P INTENSIVE 1500-1200**  
Plafoniera stagna ideale per l'installazione a 10 mt di altezza. Apparecchio prolungabile completo di cavo d'alimentazione passante per trasporto d'energia 3x1,0 mm<sup>2</sup>. Connettori maschio-femmina in testata. 7PR3702-V non inclusa.

Corrosion-proof LED lighting fittings ideal for 10 mt height installation. Extendable luminaire complete with power through cable for energy transmission 3x1,0 mm<sup>2</sup>. Male-female connectors on end covers. 7PR3702-V not included.

LP - T | Temperatura ambiente min e max | Min and max room temperature: (-20° +45°)

T | Temperatura ambiente min e max | Min and max room temperature: (-20° +40°)

TT | T Temperatura ambiente min e max | Min and max room temperature: (-20° +35°)

\* Lumen nominali LED max a 25° | Nominal lumen at max 25°

\*\* Potenza dei LED | LED power

\*\*\* Flusso totale in uscita dall'apparecchio a temperatura di lavoro (Ta 25° - 4.000 K). Total lighting fitting flux output at working temperature (Ta 25° - 4.000 K). (3.000 K -8% - CRI 90 -10%).

Fotometrie | Photometrics  
p. 271

Schema di cablaggio | Connection scheme  
p. XXVIII-XXIX

Descrizione prodotto | Product description  
p. 270

Accessori | Accessories  
p. 281



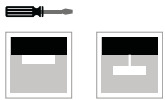
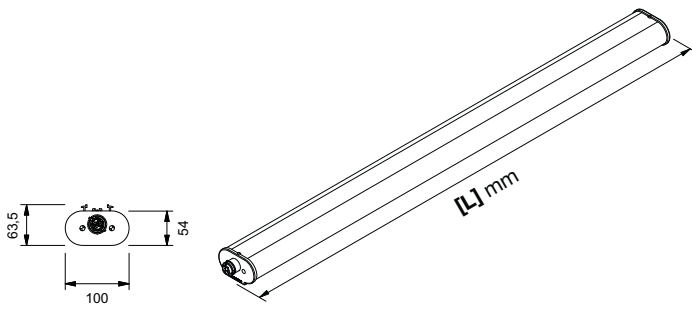

# INNOVA CONCENTRANTE SATINATO/SATIN

A RICHIESTA | ON REQUEST



Relamping	Lumen LED*	Watt LED**	Lumen Out***	Watt	Lumen Watt Out	Configurazione LED LED configuration	Code Code	Cod. Prolungabile Extension Code	K	Alimentazione Power Supply	Schermo Diffuser
<b>[L] Lunghezza/Lenght - 1565 mm   Prolungabile/Extendable - 1585 mm</b>											
SP	1x58	4100	22,5	3264	24	> 136	INCC27	INCCP27	N: 4.000	— : CAE A RICHIESTA   ON REQUEST DL: DALI PD: PUSH DIM	satinato satin
XP	2x58	8000	49	6386	51,5	> 124	INCC53	INCCP53	C: 6.000		
<b>[L] Lunghezza/Lenght - 1190 mm   Prolungabile/Extendable - 1210 mm</b>											
SP	1x36	3075	16,5	2448	18	> 136	INCC20	INCCP20	N: 4.000	— : CAE A RICHIESTA   ON REQUEST DL: DALI PD: PUSH DIM	satinato satin
XP	2x36	6000	36,5	4812	38,5	> 124	INCC40	INCCP40	C: 6.000		



**INNOVA CONCENTRANTE 1500-1200**  
Plafoniera stagna ideale per l'installazione a 6 mt di altezza. Presa femmina per alimentazione da cablare (7PR3702-V) inclusa, lunghezza 54 mm.

*Corrosion-proof LED lighting fittings ideal for 10 mt height installation. Female socket to be wired (7PR3702-V) included, length 54 mm.*

**INNOVA/P CONCENTRANTE 1500-1200**  
Plafoniera stagna ideale per l'installazione a 6 mt di altezza. Apparecchio prolungabile completo di cavo d'alimentazione passante per trasporto d'energia 3x1,0 mm<sup>2</sup>. Connettori maschio-femmina in testata. 7PR3702-V non inclusa.

*Corrosion-proof LED lighting fittings ideal for 6 mt height installation. Extendable luminaire complete with power through cable for energy transmission 3x1,0 mm<sup>2</sup>. Male-female connectors on end covers. 7PR3702-V not included.*

**SP - XP**  
Temperatura ambiente min e max | Min and max room temperature:  
**(-20° +40°)**

\* Lumen nominali LED max a 25° | Nominal lumen at max 25°

\*\* Potenza dei LED | LED power

\*\*\* Flusso totale in uscita dall'apparecchio a temperatura di lavoro (Ta 25° - 4.000 K).  
Total lighting fitting flux output at working temperature (Ta 25° - 4.000 K).  
(3.000 K -8% - CRI 90 -10%).



Accessori | Accessories  
p. 281



Descrizione prodotto | Product description  
p. 270



Schema di cablaggio | Connection scheme  
p. XXVIII-XXIX



Fotometrie | Photometries  
p. 271

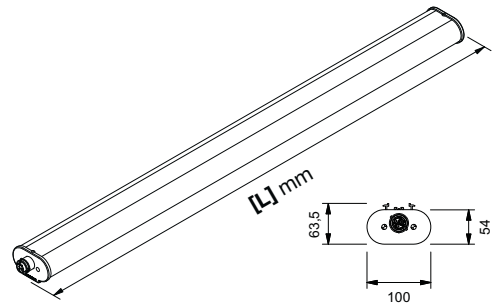
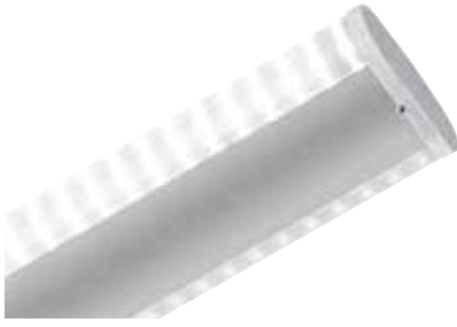

# INNOVA PARK SATINATO/SATIN



A RICHIESTA | ON REQUEST

<b>5Y WARRANTY</b> 5% FAILURE RATE	<b>60.000 h</b> LED LIFETIME L90B10	<b>100.000 h</b> LED LIFETIME L70B50
---------------------------------------	--	---

>90 CRI	EM EN 60598-2-22	DL DALI	PD PUSH DIM	WIRELESS	⚡
------------	---------------------	------------	----------------	----------	---

Relamping	Lumen LED*	Watt LED**	Lumen Out***	Watt	Lumen Watt Out	Configurazione LED LED configuration	
<b>[L] Lunghezza/Lenght - 1565 mm   Prolungabile/Extendable - 1585 mm</b>							
LP	2X49	8616	43	6720	46	> 146	===
T	2X58	9460	48	7380	52	> 141	===
TT	2X80	12040	65	9390	70	> 134	===
<b>[L] Lunghezza/Lenght - 1190 mm   Prolungabile/Extendable - 1210 mm</b>							
LP	2X28	6460	32	4964	34	> 146	===
T	2X36	7100	36	5358	38	> 141	===
TT	2X54	9030	48	6900	51,5	> 134	===
<b>[L] Lunghezza/Lenght - 810 mm   Prolungabile/Extendable - 830 mm</b>							
LP	1X36	4200	21,5	3358	23	> 146	===
T	1X58	4730	24	3670	26	> 141	===
TT	1X80	6020	32,5	4690	35	> 134	===

Codice Code	Cod. Prolungabile Extension Code	K	Alimentazione Power Supply	Schermo Diffuser
INPKXS43	INPKXSP43	N: 4.000	- : CAE	satinato satin
INPK57	INPKP57	C: 6.000	A RICHIESTA   ON REQUEST DL: DALI PD: PUSH DIM	
INPKT66	INPKTP66			
INPKXS33	INPKXSP33	N: 4.000	- : CAE	satinato satin
INPK43	INPKP43	C: 6.000	A RICHIESTA   ON REQUEST DL: DALI PD: PUSH DIM	
INPKT50	INPKTP50			
INPKXS22	INPKXSP22	N: 4.000	- : CAE	satinato satin
INPK29	INPKP29	C: 6.000	A RICHIESTA   ON REQUEST DL: DALI PD: PUSH DIM	
INPKT34	INPKTP34			

CE	⊕	>80 CRI	IP67 EN 60529	230 V 2014/35/UE	50/60 Hz	IK 09 EN 60068	850° EN 60695	A++ A+ A	RG 0 EN 62471	🏠
----	---	------------	------------------	---------------------	-------------	-------------------	------------------	----------------	------------------	---

### INNOVA PARK 1500-1200-800

Presse femmina per alimentazione da cablare (7PR3702-V) **inclusa**, lunghezza 54 mm.

Female socket to be wired (7PR3702-V) **included**, length 54 mm.

### IINNOVA/P PARK 1500-1200-800

Apparecchio prolungabile completo di cavo d'alimentazione passante per trasporto d'energia 3x1,0 mm<sup>2</sup>. Connettori maschio-femmina in testata. 7PR3702-V **non inclusa**.

Extendable luminaire complete with power through cable for energy transmission 3x1,0 mm<sup>2</sup>. Male-female connectors on end covers. 7PR3702-V **not included**.

**LP** | Temperatura ambiente min e max | *Min and max room temperature:*  
**(-20° +45°)**

**T** | Temperatura ambiente min e max | *Min and max room temperature:*  
**(-20° +40°)**

**TT** | Temperatura ambiente min e max | *Min and max room temperature:*  
**(-20° +35°)**

\* Lumen nominali LED max a 25° | *Nominal lumen at max 25°*

\*\* Potenza dei LED | *LED power*

\*\*\* Flusso totale in uscita dall'apparecchio a temperatura di lavoro (Ta 25° - 4.000 K).  
*Total lighting fitting flux output at working temperature (Ta 25° - 4.000 K).*  
(3.000 K -8% - CRI 90 -10%).



Fotometrie | *Photometrics*  
p. 271



Schema di cablaggio | *Connection scheme*  
p. XXVIII-XXIX



Descrizione prodotto | *Product description*  
p. 270



Accessori | *Accessories*  
p. 281

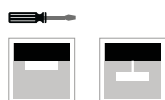
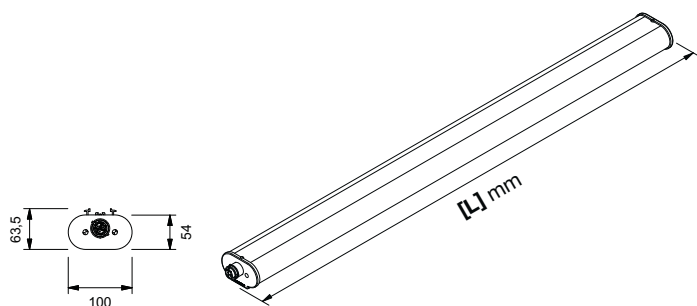

# INNOVA ASIMMETRICA SATINATO/SATIN

A RICHIESTA | ON REQUEST



<b>5Y WARRANTY</b> 5% FAILURE RATE	<b>60.000 h</b> LED LIFETIME L90B10	<b>100.000 h</b> LED LIFETIME L70B50
---------------------------------------	--	---

Relamping	Lumen LED*	Watt LED**	Lumen Out***	Watt	Lumen Watt Out	Configurazione LED LED configuration	Code Code	Cod. Prolungabile Extension Code	K	Alimentazione Power Supply	Schermo Diffuser
<b>[L] Lunghezza/Lenght - 1565 mm   Prolungabile/Extendable - 1585 mm</b>											
LP	1x58	3710	18,5	2652	19,5	> 136	INAS27	INASP27	W: 3.000 N: 4.000	— : CAE A RICHIESTA   ON REQUEST DL: DALI PD: PUSH DIM	satinato satin
XP	2x58	8000	49	6386	51,5	> 124	INAS53	INASP53	C: 6.000		
<b>[L] Lunghezza/Lenght - 1190 mm   Prolungabile/Extendable - 1210 mm</b>											
LP	1x36	2793	13,5	1972	14,5	> 136	INAS20	INASP20	W: 3.000 N: 4.000	— : CAE A RICHIESTA   ON REQUEST DL: DALI PD: PUSH DIM	satinato satin
XP	2x36	6000	36,4	4774	38,5	> 124	INAS40	INASP40	C: 6.000		
<b>[L] Lunghezza/Lenght - 810 mm   Prolungabile/Extendable - 830 mm</b>											
LP	1x28	1855	9	1360	10	> 136	INAS14	INASP14	W: 3.000 N: 4.000	— : CAE A RICHIESTA   ON REQUEST DL: DALI PD: PUSH DIM	satinato satin
XP	2x28	4000	24,5	3221	26	> 124	INAS26	INASP26	C: 6.000		



### INNOVA ASIMMETRICA 1500-1200-800

Presse femmina per alimentazione da cablare (7PR3702-V) **inclusa**, lunghezza 54 mm.

Female socket to be wired (7PR3702-V) **included**, length 54 mm.

### IINNOVA/P ASIMMETRICA 1500-1200-800

Apparecchio prolungabile completo di cavo d'alimentazione passante per trasporto d'energia 3x1,0 mm<sup>2</sup>. Connettori maschio-femmina in testata. 7PR3702-V **non inclusa**.

Extendable luminaire complete with power through cable for energy transmission 3x1,0 mm<sup>2</sup>. Male-female connectors on end covers. 7PR3702-V **not included**.

### LP-XP

Temperatura ambiente min e max | Min and max room temperature:

**(-20° +40°)**

\* Lumen nominali LED max a 25° | Nominal lumen at max 25°

\*\* Potenza dei LED | LED power

\*\*\* Flusso totale in uscita dall'apparecchio a temperatura di lavoro (Ta 25° - 4.000 K).  
Total lighting fitting flux output at working temperature (Ta 25° - 4.000 K).  
(3.000 K -8% - CRI 90 -10%).



Accessori | Accessories  
p. 281



Descrizione prodotto | Product description  
p. 270



Schema di cablaggio | Connection scheme  
p. XXVIII-XXIX



Fotometrie | Photometries  
p. 271

# GAMMA PRODOTTI | PRODUCT RANGE

## INNOVA APPLICAZIONI ESTREME • INNOVA EXTREME APPLICATIONS



### INNOVA ARCTIC -25°C +40°C (1500-1200) SATINATO/SATIN p. 278

Corpo unico in policarbonato coestruso satinato ad elevata resistenza meccanica protetto ai raggi UV, a mezzo di coostruzione JEDEX. Riflettore interno in alluminio con funzione di dissipatore. Testate di chiusura in policarbonato stampato. Valvola di sfiato anti-condensa. Sistema di fissaggio a sospensione. Sorgente luminosa LED. Emissione diretta. Non idonea per applicazioni esterne. Alimentazione elettronica CAE. A richiesta: dimmerabile DALI (cod. DL) specificare se con funzione PUSH DIM (cod. PD).

*One piece body made of coextruded satin polycarbonate with high mechanical resistance UV-resistant (anti UV system named JEDEX). Internal louver with heat sink function. Polycarbonate endcaps. included Protective Vent. Suspension fixing system. LED light source. Direct light emission. Not suitable for outdoor application. Built in electronic driver CAE. On request: dimmable DALI (code DL) PUSH DIM function (code PD) to be requested.*



### INNOVA ARCTIC -40°C +40°C (1500-1200) SATINATO/SATIN p. 279

Corpo unico in policarbonato coestruso satinato ad elevata resistenza meccanica protetto ai raggi UV, a mezzo di coostruzione JEDEX. Riflettore interno in alluminio con funzione di dissipatore. Testate di chiusura in policarbonato stampato. Valvola di sfiato anti-condensa. Sistema di fissaggio a sospensione. Sorgente luminosa LED. Emissione diretta. Non idonea per applicazioni esterne. Alimentazione elettronica CAE resistente alle basse temperature. A richiesta: dimmerabile DALI (cod. DL) specificare se con funzione PUSH DIM (cod. PD).

*One piece body made of coextruded satin polycarbonate with high mechanical resistance UV-resistant (anti UV system named JEDEX). Internal louver with heat sink function. Polycarbonate endcaps. included Protective Vent. Suspension fixing system. LED light source. Direct light emission. Not suitable for outdoor application. Built in electronic driver CAE. On request: dimmable DALI (code DL) PUSH DIM function (code PD) to be requested.*



### INNOVA SAHARA -20°C +70°C (1500-1200) SATINATO/SATIN p. 280

Corpo unico in policarbonato coestruso satinato ad elevata resistenza meccanica protetto ai raggi UV, a mezzo di coostruzione JEDEX. Riflettore interno in alluminio con funzione di dissipatore. Testate di chiusura in policarbonato stampato. Valvola di sfiato anti-condensa. Sistema di fissaggio a plafone o sospensione. Sorgente luminosa LED. Emissione diretta. Non idonea per applicazioni esterne. Alimentazione elettronica CAE resistente alle alte temperature. A richiesta: dimmerabile DALI (cod. DL) specificare se con funzione PUSH DIM (cod. PD).

*One piece body made of coextruded satin polycarbonate with high mechanical resistance UV-resistant (anti UV system named JEDEX). Internal louver with heat sink function. Polycarbonate endcaps. included Protective Vent. Suspension fixing system. LED light source. Direct light emission. Not suitable for outdoor application. Built in electronic driver CAE. On request: dimmable DALI (code DL) PUSH DIM function (code PD) to be requested.*

# FOTOMETRIE | PHOTOMETRIES

INNOVA APPLICAZIONI ESTREME • INNOVA EXTREME APPLICATIONS

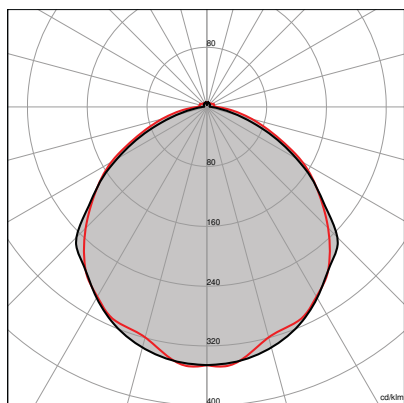

**INNOVA ARCTIC -25°C +40°C**  
SATINATO/SATIN

LP T

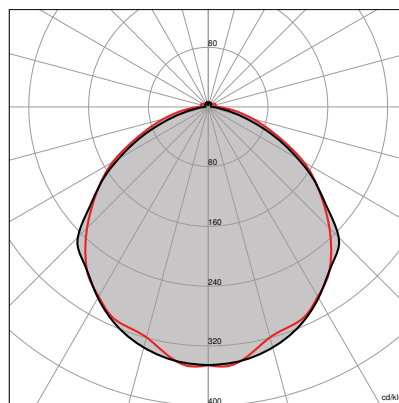

**INNOVA ARCTIC -40°C +40°C**  
SATINATO/SATIN

LP T

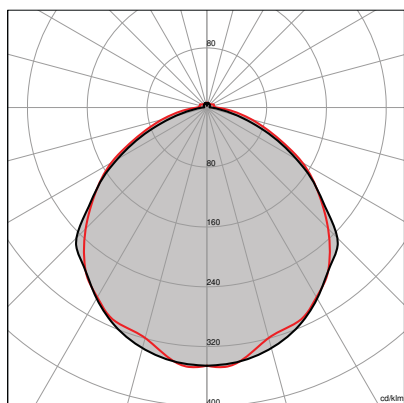

**INNOVA SAHARA -20°C +70°C**  
SATINATO/SATIN

LP T



Rimani aggiornato  
Keep up to date



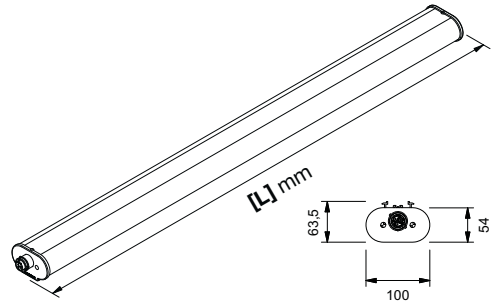

# INNOVA ARCTIC -25°C + 40°C

## SATINATO/SATIN

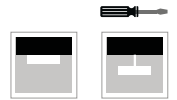

A RICHIESTA | ON REQUEST

<b>5Y WARRANTY</b> 5% FAILURE RATE	<b>60.000 h</b> LED LIFETIME L90B10	<b>100.000 h</b> LED LIFETIME L70B50
---------------------------------------	--	---

>90 CRI	EM EN 60598-2-22	DL DALI	PD PUSH DIM	WIRELESS	⚡
------------	---------------------	------------	----------------	----------	---

Relamping	Lumen LED*	Watt LED**	Lumen Out***	Watt	Lumen Watt Out	Configurazione LED LED configuration	Codice Code	K	Alimentazione Power Supply	Schermo Diffuser
<b>[L] Lunghezza/Length - 1565 mm</b>										
LP	1x58	<b>4425</b>	20,5	4025	22	> 182	————	<b>INATLP1</b>	<b>W:</b> 3.000 <b>N:</b> 4.000 <b>C:</b> 6.000 — : CAE A RICHIESTA   ON REQUEST <b>DL:</b> DALI <b>PD:</b> PUSH DIM	<b>satinato satin</b>
T	1x80	<b>4700</b>	24	4230	26	> 162	————	<b>INATT1</b>		
LP	2x58	<b>8880</b>	40	7950	43	> 184	=====	<b>INATLP2</b>		
T	2x80	<b>10800</b>	54	9700	57	> 170	=====	<b>INATT2</b>		
<b>[L] Lunghezza/Length - 1190 mm</b>										
LP	1x36	<b>3320</b>	15	3000	16,5	> 182	————	<b>INATLP3</b>	<b>W:</b> 3.000 <b>N:</b> 4.000 <b>C:</b> 6.000 — : CAE A RICHIESTA   ON REQUEST <b>DL:</b> DALI <b>PD:</b> PUSH DIM	<b>satinato satin</b>
T	1x54	<b>3525</b>	18	3159	19,5	> 162	————	<b>INATT3</b>		
LP	2x36	<b>6640</b>	31	6070	33	> 184	=====	<b>INATLP4</b>		
T	2x54	<b>8100</b>	40,5	7225	42,5	> 170	=====	<b>INATT4</b>		

CE	⊕	>80 CRI	IP67 EN 60529	230 V 2014/35/UE	50/60 Hz	IK 09 EN 60068	850° EN 60695	A++ A+ A	RG 0 EN 62471	🏠
----	---	------------	------------------	---------------------	-------------	-------------------	------------------	----------------	------------------	---

**INNOVA ARCTIC -25°C + 40°C**  
**Plafoniera stagna a LED con temperatura d'esercizio -25°C +40°C.**  
 Presa femmina per alimentazione da cablare (7PR3702-V) **inclusa**, lunghezza 54 mm.  
**Corrosion-proof LED lighting fittings for operating temperatures -25°C +40°C.**  
 Female socket to be wired (7PR3702-V) **included**, length 54mm.

**LP - T | Temperatura ambiente min e max | Min and max room temperature: (-25° +40°)**

\* Lumen nominali LED max a 25° | Nominal lumen at max 25°

\*\* Potenza dei LED | LED power

\*\*\* Flusso totale in uscita dall'apparecchio a temperatura di lavoro (Ta 25° - 4.000 K).  
 Total lighting fitting flux output at working temperature (Ta 25° - 4.000 K).  
 (3.000 K -8% - CRI 90 -10%).



Fotometrie | Photometrics  
p. 277



Schema di cablaggio | Connection scheme  
p. XXVIII-XXIX



Descrizione prodotto | Product description  
p. 276



Accessori | Accessories  
p. 281



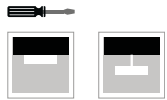
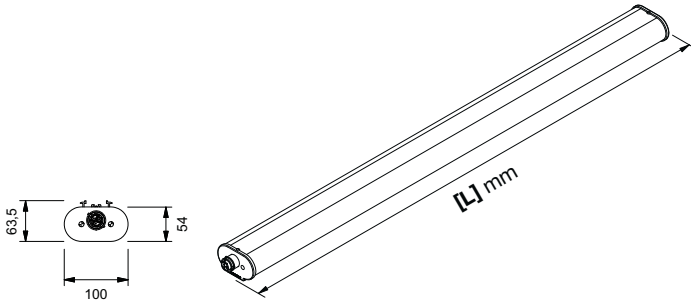

# INNOVA ARCTIC -40°C +40°C SATINATO/SATIN

A RICHIESTA | ON REQUEST



<b>5Y WARRANTY</b> 5% FAILURE RATE	<b>60.000 h</b> LED LIFETIME L90B10	<b>100.000 h</b> LED LIFETIME L70B50
---------------------------------------	--	---

Relamping	Lumen LED*	Watt LED**	Lumen Out***	Watt	Lumen Watt Out	Configurazione LED LED configuration	Codice Code	K	Alimentazione Power Supply	Schermo Diffuser
<b>[L] Lunghezza/Lenght - 1565 mm</b>										
LP	1x58	<b>4425</b>	20,5	4025	22	> 182	—	<b>INAPLP1</b>	<b>W:</b> 3.000 <b>N:</b> 4.000 <b>C:</b> 6.000 — : CAE A RICHIESTA   ON REQUEST <b>DL:</b> DALI <b>PD:</b> PUSH DIM	<b>satinato satin</b>
T	1x80	<b>4700</b>	24	4230	26	> 162	—	<b>INAPLT1</b>		
LP	2x58	<b>8880</b>	40	7950	43	> 184	==	<b>INAPLP2</b>		
T	2x80	<b>10800</b>	54	9700	57	> 170	==	<b>INAPT2</b>		
<b>[L] Lunghezza/Lenght - 1190 mm</b>										
LP	1x36	<b>3320</b>	15	3000	16,5	> 182	—	<b>INAPLP3</b>	<b>W:</b> 3.000 <b>N:</b> 4.000 <b>C:</b> 6.000 — : CAE A RICHIESTA   ON REQUEST <b>DL:</b> DALI <b>PD:</b> PUSH DIM	<b>satinato satin</b>
T	1x54	<b>3525</b>	18	3159	19,5	> 162	—	<b>INAPT3</b>		
LP	2x36	<b>6640</b>	31	6070	33	> 184	==	<b>INAPLP4</b>		
T	2x54	<b>8100</b>	40,5	7225	42,5	> 170	==	<b>INAPT4</b>		



**INNOVA ARCTIC -25°C + 40°C**  
**Plafoniera stagna a LED con temperatura d'esercizio -40°C +40°C.**  
 Presa femmina per alimentazione da cablare (7PR3702-V) **inclusa**, lunghezza 54 mm.  
**Corrosion-proof LED lighting fittings for operating temperatures -40°C +40°C.**  
 Female socket to be wired (7PR3702-V) **included**, length 54mm.

**LP - T | Temperatura ambiente min e max | Min and max room temperature: (-40° +40°)**

\* Lumen nominali LED max a 25° | Nominal lumen at max 25°

\*\* Potenza dei LED | LED power

\*\*\* Flusso totale in uscita dall'apparecchio a temperatura di lavoro (Ta 25° - 4.000 K).  
 Total lighting fitting flux output at working temperature (Ta 25° - 4.000 K).  
 (3.000 K -8% - CRI 90 -10%).

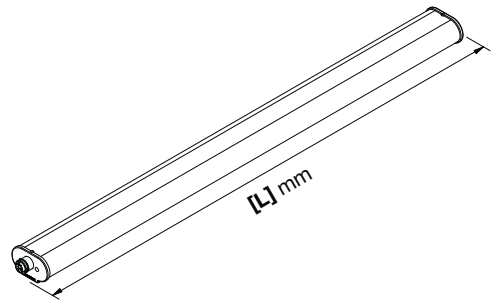

# INNOVA SAHARA -20°C +70°C SATINATO/SATIN



A RICHIESTA | ON REQUEST

<b>5Y WARRANTY</b> 5% FAILURE RATE	<b>60.000 h</b> LED LIFETIME L90B10	<b>100.000 h</b> LED LIFETIME L70B50
---------------------------------------	--	---

>90 CRI	EM EN 60598-2-22	DL DALI	PD PUSH DIM	WIRELESS	⚡
------------	---------------------	------------	----------------	----------	---

Relamping	Lumen LED*	Watt LED**	Lumen Out***	Watt	Lumen Watt Out	Configurazione LED LED configuration	Codice Code	K	Alimentazione Power Supply	Schermo Diffuser	
<b>[L] Lunghezza/Length - 1565 mm</b>											
HH	1x58	<b>4480</b>	21	3210	23	> 140	—	<b>INSHH11</b>	<b>W:</b> 3.000	— : CAE A RICHIESTA   ON REQUEST <b>DL:</b> DALI <b>PD:</b> PUSH DIM	<b>satinato satin</b>
HH	2x58	<b>8850</b>	43	6420	46	> 139	==	<b>INSHH12</b>	<b>N:</b> 4.000		
HH	2x80	<b>13120</b>	61	9425	65	> 145	===	<b>INSHH16</b>	<b>C:</b> 6.000		
<b>[L] Lunghezza/Length - 1190 mm</b>											
HH	1x36	<b>3360</b>	15	2407	17	> 139	—	<b>INSHH9</b>	<b>W:</b> 3.000	— : CAE A RICHIESTA   ON REQUEST <b>DL:</b> DALI <b>PD:</b> PUSH DIM	<b>satinato satin</b>
HH	2x36	<b>6624</b>	32	5250	34	> 139	==	<b>INSHH10</b>	<b>N:</b> 4.000		
HH	2x54	<b>9840</b>	51	7870	54	> 145	===	<b>INSHH14</b>	<b>C:</b> 6.000		

CE	⊕	>80 CRI	IP67 EN 60529	230 V 2014/35/UE	50/60 Hz	IK 09 EN 60068	850° EN 60695	A++ A+	RG 0 EN 62471	🏠
----	---	------------	------------------	---------------------	-------------	-------------------	------------------	-----------	------------------	---

**INNOVA ARCTIC -25°C + 40°C**  
Plafoniera stagna a LED con temperatura d'esercizio -25°C +40°C.  
Presa femmina per alimentazione da cablare (7PR3702-V) **inclusa**, lunghezza 54 mm.

**Corrosion-proof LED lighting fittings for operating temperatures -25°C +40°C.**  
Female socket to be wired (7PR3702-V) **included**, length 54mm.

**HH** | Temperatura ambiente min e max | *Min and max room temperature:*  
**(-20° +70°)**

\* Lumen nominali LED max a 25° | *Nominal lumen at max 25°*

\*\* Potenza dei LED | *LED power*

\*\*\* Flusso totale in uscita dall'apparecchio a temperatura di lavoro (Ta 25° - 4.000 K).  
*Total lighting fitting flux output at working temperature (Ta 25° - 4.000 K).*  
(3.000 K -8% - CRI 90 -10%).



Fotometrie | *Photometries*  
p. 277









Schema di cablaggio | *Connection scheme*  
p. XXVIII-XXIX



Descrizione prodotto | *Product description*  
p. 276



Accessori | *Accessories*  
p. 281

	DESCRIZIONE ACCESSORIO   ACCESSORY DESCRIPTION	CODICE   CODE
	<p><b>KIT FUSIBILE 10A</b> Fusibile da utilizzare in testata di alimentazione della linea a protezione del cavo di alimentazione passante (se non protetto diversamente). nella versione prolungabile protezione garantita per max 10 alimentatori.</p> <p><b>FUSE KIT 10A</b> <i>Fuse for feeding cable protection (if not otherwise protected) to be installed on end cover. For extendable version, guaranteed protection for max 10 drivers.</i></p>	<b>IN-KIT-FUSE10A</b>
	<p><b>STAFFE DI FISSAGGIO ANTIVANDOLO</b> <b>FIXING SPRINGS VANDAL PROOF</b></p>	<b>IN-MOL-AV</b>
	<p><b>ATTACCO CLEAN</b> Per uso alimentare</p> <p><b>CLEAN CONNECTION</b> <i>For feed use</i></p>	<b>IN1200 IN1500</b>
	<p><b>SENSORI INFRAROSSI</b> Kit Infrarossi sensore movimento</p> <p><b>INFRARED SENSOR</b> <i>Infrared Kit motion sensor</i></p>	<b>ININF</b>
	<p><b>SENSORE MICROONDE</b> Kit Micronde sensore movimento</p> <p><b>MICROWAVE SENSOR</b> <i>Microwave Kit motion sensor</i></p>	<b>INMIC</b>
	<p><b>SURGE PROTECTOR</b> Per sistema monofase L 155 mm <i>For a monophase system L 155 mm</i></p> <hr/> <p><b>SURGE PROTECTOR</b> Per sistema trifase L 245 mm <i>For a threephase system L 245 mm</i></p>	<b>INSF1</b>
	<p><b>PRESA FEMMINA</b> Per alimentazione da cablare (da ordinare per INNOVA/P). Lunghezza 54mm.</p> <p><b>FEMALE SOCKET</b> <i>Female socket to be wired (to be ordered for INNOVA/P) Length 54 mm.</i></p>	<b>7PR3702-V</b> (3 poli) <b>7PR5702-V</b> (5 poli)
	<p><b>SPINA MASCHIO</b> Per alimentazione da cablare</p> <p><b>MALE PLUG</b> <i>Male plug to be wired</i></p>	<b>7PR3701</b> (3 poli) <b>7PR5701</b> (5 poli)
	<p><b>TERMINALE</b> Chiusura file</p> <p><b>END CAP</b></p>	<b>IN-KIT-TAP</b>
	<p><b>INNESTO TUBO</b> Ø 20mm</p> <p><b>JOINT FOR RIGIDE CONDUIT</b> Ø 20mm</p>	<b>7PR3700-C</b>

# GAMMA PRODOTTI | PRODUCT RANGE

## INNOVA DIMENSIONI ESTREME • INNOVA EXTREME DIMENSIONS



### INNOVA LONG (3000-2400-1900) SATINATO/SATIN

p. 284-285-286

Corpo unico in policarbonato coestruso satinato ad elevata resistenza meccanica protetto ai raggi UV, a mezzo di coostruzione JEDEX. Riflettore interno in alluminio con funzione di dissipatore. Testate di chiusura in policarbonato stampato. Sistema di fissaggio a sospensione. Sorgente luminosa LED. Emissione diretta. Non idonea per applicazioni esterne. Alimentazione elettronica CAE. A richiesta: dimmerabile DALI (cod. DL) specificare se con funzione PUSH DIM (cod. PD).

*One piece body made of coextruded satin polycarbonate with high mechanical resistance UV-resistant (anti UV system named JEDEX). Internal louver with heat sink function. Polycarbonate endcaps. Suspension fixing system. LED light source. Direct light emission. Not suitable for outdoor application. Built in electronic driver CAE. On request: dimmable DALI (code DL) PUSH DIM function (code PD) to be requested.*



### INNOVA LONG (3000-2400-1900) OPALE/OPAL

p. 288-289-290

Corpo unico in policarbonato coestruso opale ad elevata resistenza meccanica protetto ai raggi UV, a mezzo di coostruzione JEDEX. Riflettore interno in alluminio con funzione di dissipatore. Testate di chiusura in policarbonato stampato. Sistema di fissaggio a sospensione. Sorgente luminosa LED. Emissione diretta. Non idonea per applicazioni esterne. Alimentazione elettronica CAE. A richiesta: dimmerabile DALI (cod. DL) specificare se con funzione PUSH DIM (cod. PD).

*One piece body made of coextruded opal polycarbonate with high mechanical resistance UV-resistant (anti UV system named JEDEX). Internal louver with heat sink function. Polycarbonate endcaps. Suspension fixing system. LED light source. Direct light emission. Not suitable for outdoor application. Built in electronic driver CAE. On request: dimmable DALI (code DL) PUSH DIM function (code PD) to be requested.*



### INNOVA LONG (3000-2400-1900) RIGATO/RIBBED

p. 292-293-294

Corpo unico in policarbonato coestruso rigato ad elevata resistenza meccanica protetto ai raggi UV, a mezzo di coostruzione JEDEX. Riflettore interno in alluminio con funzione di dissipatore. Testate di chiusura in policarbonato stampato. Sistema di fissaggio a sospensione. Sorgente luminosa LED. Emissione diretta. Non idonea per applicazioni esterne. Alimentazione elettronica CAE. A richiesta: dimmerabile DALI (cod. DL) specificare se con funzione PUSH DIM (cod. PD).

*One piece body made of coextruded ribbed polycarbonate with high mechanical resistance UV-resistant (anti UV system named JEDEX). Internal louver with heat sink function. Polycarbonate endcaps. Suspension fixing system. LED light source. Direct light emission. Not suitable for outdoor application. Built in electronic driver CAE. On request: dimmable DALI (code DL) PUSH DIM function (code PD) to be requested.*

# FOTOMETRIE | PHOTOMETRIES

INNOVA DIMENSIONI ESTREME • INNOVA EXTREME DIMENSIONS

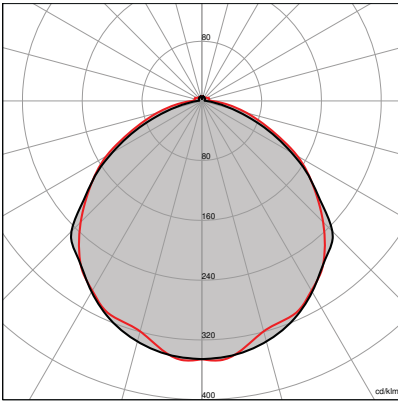

**INNOVA LONG**  
SATINATO/SATIN

LP TT MG

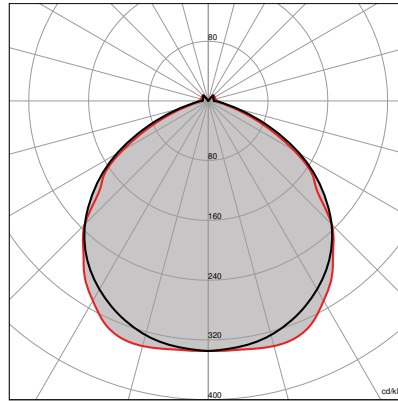

**INNOVA LONG**  
SATINATO/SATIN

XP

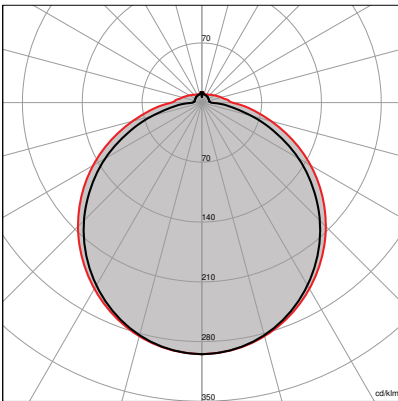

**INNOVA LONG**  
OPALE/OPAL

LP TT MG

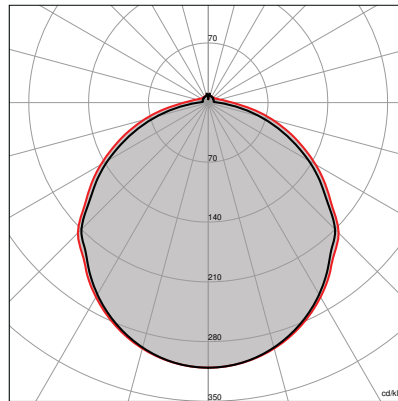

**INNOVA LONG**  
OPALE/OPAL

XP

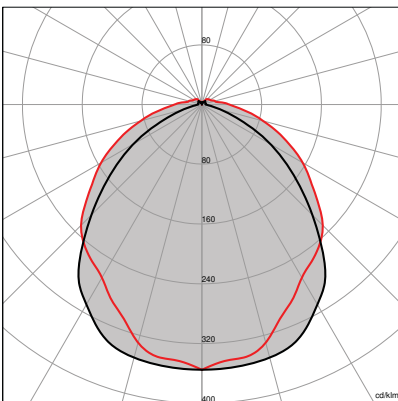

**INNOVA LONG**  
RIGATO/RIBBED

LP TT MG

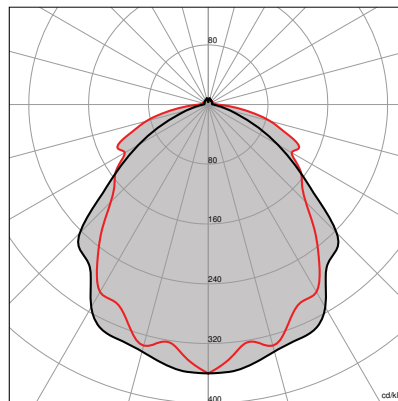

**INNOVA LONG**  
RIGATO/RIBBED

XP



Rimani aggiornato  
Keep up to date

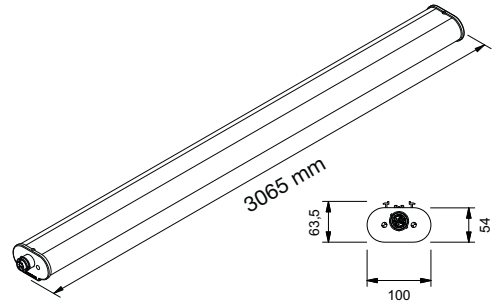

# INNOVA LONG 3000

## SATINATO/SATIN

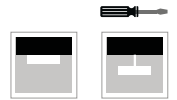

A RICHIESTA | ON REQUEST

**5Y WARRANTY**  
5% FAILURE RATE

**60.000 h**  
LED LIFETIME L90B10

**100.000 h**  
LED LIFETIME L70B50

>90  
CRI

EM  
EN 60598-2-22

DL  
DALI

PD  
PUSH DIM

WIRELESS

Relamping	Lumen LED*	Watt LED**	Lumen Out***	Watt	Lumen Watt Out	Configurazione LED LED configuration
<b>[L] Lunghezza/Lenght - 3065 mm   Prolungabile/Extendable - 3085 mm</b>						
LP	1+1x58	8880	40	6400	43	> 149
TT	1+1x80	12000	64	8830	69	> 128
MG	2+2x49	14200	70	10380	75	> 139
XP	1+1x72	8170	48	6250	52	> 120
<hr/>						
LP	2+2x58	17760	80	12850	86	> 149
TT	2+2x80	24000	128	17700	138	> 128
MG	4+4x49	28400	140	20750	150	> 139
XP	2+2x58	16000	98	11800	103	> 114

Code Code	Cod. Prolungabile Extension Code	K	Alimentazione Power Supply	Schermo Diffuser
ING2	INGP2	W: 3.000	- : CAE  A RICHIESTA   ON REQUEST DL: DALI PD: PUSH DIM	satinato satin
ING4	INGP4	N: 4.000		
ING5	INGP5	C: 6.000		
ING6	INGP6			
<hr/>				
ING9	INGP9	W: 3.000	- : CAE  A RICHIESTA   ON REQUEST DL: DALI PD: PUSH DIM	satinato satin
ING11	INGP11	N: 4.000		
ING12	INGP12	C: 6.000		
ING14	INGP14			

CE

>80  
CRI

IP67  
EN 60529

230 V  
2014/35/UE

50/60  
Hz

IK 09  
EN 60068

850°  
EN 60695

RG 0  
EN 62471

**INNOVA LONG 3000**  
**INNOVA LONG adatta per il relamping 1/1 di lampade a sorgente Fluo T12 con medesime dimensioni.** Presa femmina per alimentazione da cablare (7PR3702-V) inclusa, lunghezza 54 mm.

**INNOVA LONG suitable for 1/1 relamping of Fluo T12 lamps of the same dimensions.** Female socket to be wired (7PR3702-V) included, length 54mm.

**INNOVA/P LONG 3000**  
**INNOVA LONG adatta per il relamping 1/1 di lampade a sorgente Fluo T12 con medesime dimensioni.** Apparecchio prolungabile completo di cavo d'alimentazione passante per trasporto d'energia 3x1,0 mm<sup>2</sup>. Connettori maschio-femmina in testata. 7PR3702-V non inclusa.

**INNOVA LONG suitable for 1/1 relamping of Fluo T12 lamps of the same dimensions.** Extendable luminaire complete with power through cable for energy transmission 3x1,0 mm<sup>2</sup>. Male-female connectors on end covers. 7PR3702-V not included.

LP | Temperatura ambiente min e max | *Min and max room temperature:*  
**(-20° +45°)**

XP  
 Temperatura ambiente min e max | *Min and max room temperature:*  
**(-20° +40°)**

MG-TT | Temperatura ambiente min e max | *Min and max room temperature:*  
**(-20° +35°)**

\* Lumen nominali LED max a 25° | *Nominal lumen at max 25°*

\*\* Potenza dei LED | *LED power*

\*\*\* Flusso totale in uscita dall'apparecchio a temperatura di lavoro (Ta 25° - 4.000 K).  
*Total lighting fitting flux output at working temperature. (Ta 25° - 4.000 K).*  
 (3.000 K -8% - CRI 90 -10%).



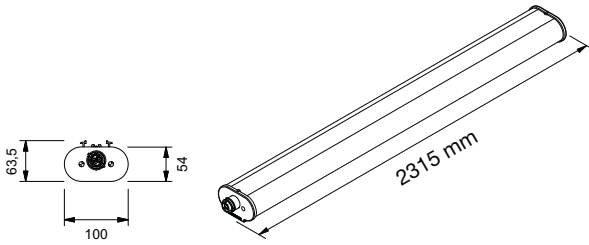

# INNOVA LONG 2400 SATINATO/SATIN

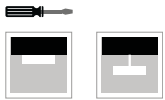

A RICHIESTA | ON REQUEST



<b>5Y WARRANTY</b> 5% FAILURE RATE	<b>60.000 h</b> LED LIFETIME L90B10	<b>100.000 h</b> LED LIFETIME L70B50
---------------------------------------	--	---

Relamping	Lumen LED*	Watt LED**	Lumen Out***	Watt	Lumen Watt Out	Configurazione LED LED configuration	Codice Code	Cod. Prolungabile Extension Code	K	Alimentazione Power Supply	Schermo Diffuser	
<b>[L] Lunghezza/Lenght - 2315 mm   Prolungabile/Extendable - 2335 mm</b>												
LP	1+1x36	6600	30	4800	32	> 149	—	ING16	INGP16	W: 3.000	— : CAE  A RICHIESTA   ON REQUEST DL: DALI PD: PUSH DIM	satinato satin
TT	1+1x54	9000	48	6640	52	> 128	—	ING18	INGP18	N: 4.000		
MG	2+2x28	10650	52	7800	56	> 139	—	ING19	INGP19	C: 6.000		
XP	1+1x50	6130	36	4688	39	> 120	—	ING20	INGP20			
LP	2+2x36	13320	60	9580	64	> 149	==	ING23	INGP23	W: 3.000	— : CAE  A RICHIESTA   ON REQUEST DL: DALI PD: PUSH DIM	satinato satin
TT	2+2x54	18000	96	13280	103	> 128	==	ING25	INGP25	N: 4.000		
MG	4+4x28	21300	104	15600	112	> 139	==	ING26	INGP26	C: 6.000		
XP	2+2x36	12000	72	8850	78	> 120	—	ING28	INGP28			



**INNOVA LONG 2400**  
**INNOVA LONG adatta per il relamping 1/1 di lampade a sorgente Fluo T12 con medesime dimensioni.** Presa femmina per alimentazione da cablare (7PR3702-V) inclusa, lunghezza 54 mm.

**INNOVA LONG suitable for 1/1 relamping of Fluo T12 lamps of the same dimensions.** Female socket to be wired (7PR3702-V) included, length 54mm.

**INNOVA/P LONG 2400**  
**INNOVA LONG adatta per il relamping 1/1 di lampade a sorgente Fluo T12 con medesime dimensioni.** Apparecchio prolungabile completo di cavo d'alimentazione passante per trasporto d'energia 3x1,0 mm<sup>2</sup>. Connettori maschio-femmina in testata. 7PR3702-V non inclusa.

**INNOVA LONG suitable for 1/1 relamping of Fluo T12 lamps of the same dimensions.** Extendable luminaire complete with power through cable for energy transmission 3x1,0 mm<sup>2</sup>. Male-female connectors on end covers. 7PR3702-V not included.

**LP** | Temperatura ambiente min e max | *Min and max room temperature:*  
**(-20° +45°)**

**XP**  
 Temperatura ambiente min e max | *Min and max room temperature:*  
**(-20° +40°)**

**MG-TT** | Temperatura ambiente min e max | *Min and max room temperature:*  
**(-20° +35°)**

\* Lumen nominali LED max a 25° | *Nominal lumen at max 25°*

\*\* Potenza dei LED | *LED power*

\*\*\* Flusso totale in uscita dall'apparecchio a temperatura di lavoro (Ta 25° - 4.000 K).  
*Total lighting fitting flux output at working temperature. (Ta 25° - 4.000 K).*  
 (3.000 K -8% - CRI 90 -10%).



Accessori | Accessories  
p. 287



Descrizione prodotto | Product description  
p. 282



Schema di cablaggio | Connection scheme  
p. XXVIII-XXIX



Fotometrie | Photometries  
p. 283

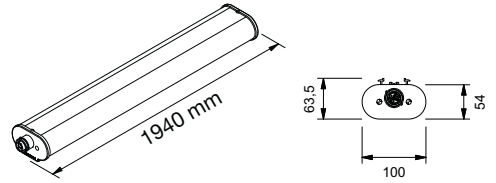

# INNOVA LONG 1900

## SATINATO/SATIN

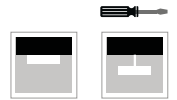

A RICHIESTA | ON REQUEST

<b>5Y WARRANTY</b> 5% FAILURE RATE	<b>60.000 h</b> LED LIFETIME L90B10	<b>100.000 h</b> LED LIFETIME L70B50
---------------------------------------	--	---

>90 CRI	EM EN 60590-2:22	DL DALI	PD PUSH DIM	WIRELESS	⚡
------------	---------------------	------------	----------------	----------	---

Relamping	Lumen LED*	Watt LED**	Lumen Out***	Watt	Lumen Watt Out	Configurazione LED LED configuration
<b>[L] Lunghezza/Lenght - 1940 mm   Prolungabile/Extendable - 1960 mm</b>						
LP	1+1x36	5500	25	3985	26,5	> 149
TT	1+1x54	7500	40	5440	42,5	> 128
MG	2+2x28	8875	43	6400	46	> 139
XP	1+1x50	5100	30	3850	32	> 120
LP	2+2x36	11100	50	7970	53,5	> 149
TT	2+2x54	15000	80	10960	85,5	> 128
MG	4+4x28	17750	87,5	13000	93,5	> 139
XP	2+2x36	10000	61	7800	65	> 120

Code Code	Cod. Prolungabile Extension Code	K	Alimentazione Power Supply	Schermo Diffuser
ING30	INGP30	W: 3.000	— : CAE	satinato satin
ING32	INGP32	N: 4.000	A RICHIESTA   ON REQUEST DL: DALI PD: PUSH DIM	
ING33	INGP33	C: 6.000		
ING34	INGP34			
ING37	INGP37	W: 3.000	— : CAE	satinato satin
ING39	INGP39	N: 4.000	A RICHIESTA   ON REQUEST DL: DALI PD: PUSH DIM	
ING40	INGP40	C: 6.000		
ING42	INGP42			

CE	⊕	>80 CRI	IP67 EN 60529	230 V 2014/35/UE	50/60 Hz	IK 09 EN 60068	850° EN 60695	AAA A+	RG 0 EN 62471	🏠
----	---	------------	------------------	---------------------	-------------	-------------------	------------------	-----------	------------------	---

**INNOVA LONG 1900**  
INNOVA LONG adatta per il relamping 1/1 di lampade a sorgente Fluo T12 con medesime dimensioni. Presa femmina per alimentazione da cablare (7PR3702-V) inclusa, lunghezza 54 mm.

INNOVA LONG suitable for 1/1 relamping of Fluo T12 lamps of the same dimensions. Female socket to be wired (7PR3702-V) included, length 54mm.

**INNOVA/P LONG 1900**  
INNOVA LONG adatta per il relamping 1/1 di lampade a sorgente Fluo T12 con medesime dimensioni. Apparecchio prolungabile completo di cavo d'alimentazione passante per trasporto d'energia 3x1,0 mm<sup>2</sup>. Connettori maschio-femmina in testata. 7PR3702-V non inclusa.

INNOVA LONG suitable for 1/1 relamping of Fluo T12 lamps of the same dimensions. Extendable luminaire complete with power through cable for energy transmission 3x1,0 mm<sup>2</sup>. Male-female connectors on end covers. 7PR3702-V not included.

LP | Temperatura ambiente min e max | Min and max room temperature: (-20° +45°)

XP  
Temperatura ambiente min e max | Min and max room temperature: (-20° +40°)

MG-TT | Temperatura ambiente min e max | Min and max room temperature: (-20° +35°)

\* Lumen nominali LED max a 25° | Nominal lumen at max 25°

\*\* Potenza dei LED | LED power

\*\*\* Flusso totale in uscita dall'apparecchio a temperatura di lavoro (Ta 25° - 4.000 K). Total lighting fitting flux output at working temperature. (Ta 25° - 4.000 K). (3.000 K -8% - CRI 90 -10%).

	DESCRIZIONE ACCESSORIO   ACCESSORY DESCRIPTION	CODICE   CODE
	<p><b>KIT FUSIBILE 10A</b> Fusibile da utilizzare in testata di alimentazione della linea a protezione del cavo di alimentazione passante (se non protetto diversamente). nella versione prolungabile protezione garantita per max 10 alimentatori.</p> <p><b>FUSE KIT 10A</b> <i>Fuse for feeding cable protection (if not otherwise protected) to be installed on end cover. For extendable version, guaranteed protection for max 10 drivers.</i></p>	<b>IN-KIT-FUSE10A</b>
	<p><b>STAFFE DI FISSAGGIO ANTIVANDOLO</b> <b>FIXING SPRINGS VANDAL PROOF</b></p>	<b>IN-MOL-AV3</b>
	<p><b>ATTACCO CLEAN</b> Per uso alimentare</p> <p><b>CLEAN CONNECTION</b> <i>For feed use</i></p>	<b>IN1900 IN2400 IN3000</b>
	<p><b>SENSORI INFRAROSSI</b> Kit Infrarossi sensore movimento</p> <p><b>INFRARED SENSOR</b> <i>Infrared Kit motion sensor</i></p>	<b>ININF</b>
	<p><b>SENSORE MICROONDE</b> Kit Micronde sensore movimento</p> <p><b>MICROWAVE SENSOR</b> <i>Microwave Kit motion sensor</i></p>	<b>INMIC</b>
	<p><b>SURGE PROTECTOR</b> Per sistema monofase L 155 mm <i>For a monophase system L 155 mm</i></p> <p><b>SURGE PROTECTOR</b> Per sistema trifase L 245 mm <i>For a threephase system L 245 mm</i></p>	<b>INSF1 INSF2</b>
	<p><b>PROLUNGA LUNGHEZZA</b> 300/600/800/1000 mm</p> <p><b>EXTENSION FOR LINE APPLICATIONS</b> <i>300/600/800/1000 mm</i></p>	<b>INHP/P/300 INHP/P/600 INHP/P/800 INHP/P/1000</b>
	<p><b>PRESA FEMMINA</b> Per alimentazione da cablare (da ordinare per INNOVA/P). Lunghezza 54mm.</p> <p><b>FEMALE SOCKET</b> <i>Female socket to be wired (to be ordered for INNOVA/P) Length 54 mm.</i></p>	<b>7PR3702-V (3 poli) 7PR5702-V (5 poli)</b>
	<p><b>SPINA MASCHIO</b> Per alimentazione da cablare</p> <p><b>MALE PLUG</b> <i>Male plug to be wired</i></p>	<b>7PR3701 (3 poli) 7PR5701 (5 poli)</b>
	<p><b>TERMINALE</b> Chiusura file</p> <p><b>END CAP</b></p>	<b>IN-KIT-TAP</b>
	<p><b>INNESTO TUBO</b> Ø 20mm</p> <p><b>JOINT FOR RIGIDE CONDUIT</b> <i>Ø 20mm</i></p>	<b>7PR3700-C</b>

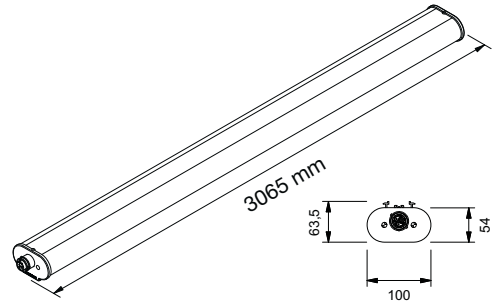

# INNOVA LONG 3000

## OPALE/OPAL

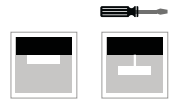

**5Y WARRANTY**  
5% FAILURE RATE

**60.000 h**  
LED LIFETIME L90B10

**100.000 h**  
LED LIFETIME L70B50

A RICHIESTA | ON REQUEST

**>90**  
CRI

**EM**  
EN 60598-2-22

DALI

PUSH DIM

WIRELESS

Relamping	Lumen LED*	Watt LED**	Lumen Out***	Watt	Lumen Watt Out	Configurazione LED LED configuration
<b>[L] Lunghezza/Lenght - 3065 mm   Prolungabile/Extendable - 3085 mm</b>						
<b>LP</b>	1+1x58	<b>8880</b>	40	6063	43	> 141
<b>TT</b>	1+1x80	<b>12000</b>	64	8350	69	> 121
<b>MG</b>	2+2x49	<b>14200</b>	70	9900	75	> 132
<b>XP</b>	1+1x72	<b>8170</b>	48	5430	52	> 114
<b>LP</b>	2+2x58	<b>17760</b>	80	12126	86	> 141
<b>TT</b>	2+2x80	<b>24000</b>	128	16700	138	> 121
<b>MG</b>	4+4x49	<b>28400</b>	140	19800	150	> 132
<b>XP</b>	2+2x58	<b>16000</b>	98	11800	103	> 114

Code Code	Cod. Prolungabile Extension Code	K	Alimentazione Power Supply	Schermo Diffuser
<b>INGO2</b>	<b>INGOP2</b>	<b>W:</b> 3.000	— : CAE  A RICHIESTA   ON REQUEST <b>DL:</b> DALI <b>PD:</b> PUSH DIM	<b>opale</b> <i>opal</i>
<b>INGO4</b>	<b>INGOP4</b>	<b>N:</b> 4.000		
<b>INGO5</b>	<b>INGOP5</b>	<b>C:</b> 6.000		
<b>INGO6</b>	<b>INGOP6</b>			
<b>INGO9</b>	<b>INGOP9</b>	<b>W:</b> 3.000	— : CAE  A RICHIESTA   ON REQUEST <b>DL:</b> DALI <b>PD:</b> PUSH DIM	<b>opale</b> <i>opal</i>
<b>INGO11</b>	<b>INGOP11</b>	<b>N:</b> 4.000		
<b>INGO12</b>	<b>INGOP12</b>	<b>C:</b> 6.000		
<b>INGO14</b>	<b>INGOP14</b>			

CE

**>80**  
CRI

**IP67**  
EN 60529

**230 V**  
2014/35/UE

**50/60**  
Hz

**IK 09**  
EN 60068

**850°**  
EN 60695

**RG 0**  
EN 62471

**INNOVA LONG 3000**  
**INNOVA LONG adatta per il relamping 1/1 di lampade a sorgente Fluo T12 con medesime dimensioni.** Presa femmina per alimentazione da cablare (7PR3702-V) inclusa, lunghezza 54 mm.

**INNOVA LONG suitable for 1/1 relamping of Fluo T12 lamps of the same dimensions.** Female socket to be wired (7PR3702-V) included, length 54mm.

**INNOVA/P LONG 3000**  
**INNOVA LONG adatta per il relamping 1/1 di lampade a sorgente Fluo T12 con medesime dimensioni.** Apparecchio prolungabile completo di cavo d'alimentazione passante per trasporto d'energia 3x1,0 mm<sup>2</sup>. Connettori maschio-femmina in testata. 7PR3702-V **non inclusa**.

**INNOVA LONG suitable for 1/1 relamping of Fluo T12 lamps of the same dimensions.** Extendable luminaire complete with power through cable for energy transmission 3x1,0 mm<sup>2</sup>. Male-female connectors on end covers. 7PR3702-V **not included**.

**LP** | Temperatura ambiente min e max | *Min and max room temperature:*  
**(-20° +45°)**

**XP**  
 Temperatura ambiente min e max | *Min and max room temperature:*  
**(-20° +40°)**

**MG-TT** | Temperatura ambiente min e max | *Min and max room temperature:*  
**(-20° +35°)**

\* Lumen nominali LED max a 25° | *Nominal lumen at max 25°*

\*\* Potenza dei LED | *LED power*

\*\*\* Flusso totale in uscita dall'apparecchio a temperatura di lavoro (Ta 25° - 4.000 K).  
*Total lighting fitting flux output at working temperature. (Ta 25° - 4.000 K).*  
 (3.000 K -8% - CRI 90 -10%).

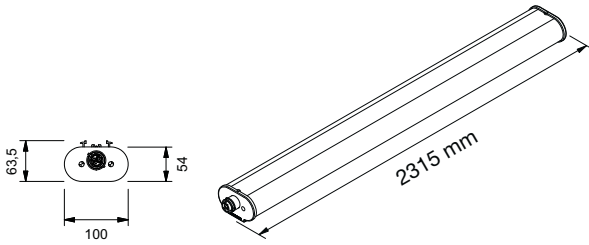

# INNOVA LONG 2400

## OPALE/OPAL

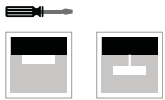

A RICHIESTA | ON REQUEST



Relamping	Lumen LED*	Watt LED**	Lumen Out***	Watt	Lumen Watt Out	Configurazione LED LED configuration	Codice Code	Cod. Prolungabile Extension Code	K	Alimentazione Power Supply	Schermo Diffuser	
<b>[L] Lunghezza/Lenght - 2315 mm   Prolungabile/Extendable - 2335 mm</b>												
LP	1+1x36	6600	30	4512	32	> 141	_____	INGO16	INGOP16	W: 3.000	- : CAE  A RICHIESTA   ON REQUEST DL: DALI PD: PUSH DIM	opale opal
TT	1+1x54	9000	48	6290	52	> 121	_____	INGO18	INGOP18	N: 4.000		
MG	2+2x28	10650	52	7400	56	> 132	_____	INGO19	INGOP19	C: 6.000		
XP	1+1x50	6130	36	4450	39	> 114	_____	INGO20	INGOP20			
LP	2+2x36	13320	60	9030	64	> 141	=====	INGO23	INGOP23	W: 3.000	- : CAE  A RICHIESTA   ON REQUEST DL: DALI PD: PUSH DIM	opale opal
TT	2+2x54	18000	96	12470	103	> 121	=====	INGO25	INGOP25	N: 4.000		
MG	4+4x28	21300	104	14790	112	> 132	=====	INGO26	INGOP26	C: 6.000		
XP	2+2x36	12000	72	8850	78	> 114	_____	INGO28	INGOP28			



**INNOVA LONG 2400**  
**INNOVA LONG adatta per il relamping 1/1 di lampade a sorgente Fluo T12 con medesime dimensioni.** Presa femmina per alimentazione da cablare (7PR3702-V) inclusa, lunghezza 54 mm.

**INNOVA LONG suitable for 1/1 relamping of Fluo T12 lamps of the same dimensions.** Female socket to be wired (7PR3702-V) included, length 54mm.

**INNOVA/P LONG 2400**  
**INNOVA LONG adatta per il relamping 1/1 di lampade a sorgente Fluo T12 con medesime dimensioni.** Apparecchio prolungabile completo di cavo d'alimentazione passante per trasporto d'energia 3x1,0 mm<sup>2</sup>. Connettori maschio-femmina in testata. 7PR3702-V non inclusa.

**INNOVA LONG suitable for 1/1 relamping of Fluo T12 lamps of the same dimensions.** Extendable luminaire complete with power through cable for energy transmission 3x1,0 mm<sup>2</sup>. Male-female connectors on end covers. 7PR3702-V not included.

**LP** | Temperatura ambiente min e max | *Min and max room temperature:*  
**(-20° +45°)**

**XP**  
 Temperatura ambiente min e max | *Min and max room temperature:*  
**(-20° +40°)**

**MG-TT** | Temperatura ambiente min e max | *Min and max room temperature:*  
**(-20° +35°)**

\* Lumen nominali LED max a 25° | *Nominal lumen at max 25°*

\*\* Potenza dei LED | *LED power*

\*\*\* Flusso totale in uscita dall'apparecchio a temperatura di lavoro (Ta 25° - 4.000 K).  
*Total lighting fitting flux output at working temperature. (Ta 25° - 4.000 K).*  
 (3.000 K -8% - CRI 90 -10%).



Accessori | Accessories  
 p. 291



Descrizione prodotto | Product description  
 p. 282



Schema di cablaggio | Connection scheme  
 p. XXVIII-XXIX



Fotometrie | Photometries  
 p. 283

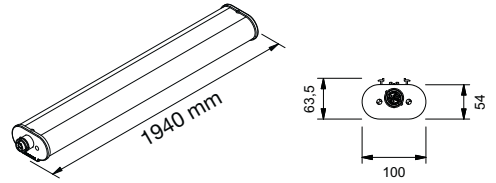

# INNOVA LONG 1900

## OPALE/OPAL

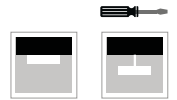

A RICHIESTA | ON REQUEST

<b>5Y WARRANTY</b> 5% FAILURE RATE	<b>60.000 h</b> LED LIFETIME L90B10	<b>100.000 h</b> LED LIFETIME L70B50
---------------------------------------	--	---

>90 CRI	EM EN 60598-2-22	DL DALI	PD PUSH DIM	WIRELESS	
------------	---------------------	------------	----------------	----------	--

Relamping	Lumen LED*	Watt LED**	Lumen Out***	Watt	Lumen Watt Out	Configurazione LED LED configuration	Code Code	Cod. Prolungabile Extension Code	K	Alimentazione Power Supply	Schermo Diffuser	
<b>[L] Lunghezza/Lenght - 1940 mm   Prolungabile/Extendable - 1960 mm</b>												
LP	1+1x36	5500	25	3740	26,5	> 141	—	ING030	INGOP30	W: 3.000	— : CAE	opale opal
TT	1+1x54	7500	40	5140	42,5	> 121	—	ING032	INGOP32	N: 4.000	A RICHIESTA   ON REQUEST DL: DALI PD: PUSH DIM	
MG	2+2x28	8875	43	6070	46	> 132	—	ING033	INGOP33	C: 6.000		
XP	1+1x50	5100	30	3638	32	> 114	—	ING034	INGOP34			
LP	2+2x36	11100	50	7540	53,5	> 141	==	ING037	INGOP37	W: 3.000	— : CAE	opale opal
TT	2+2x54	15000	80	10350	85,5	> 121	==	ING039	INGOP39	N: 4.000	A RICHIESTA   ON REQUEST DL: DALI PD: PUSH DIM	
MG	4+4x28	17750	87,5	12350	93,5	> 132	==	ING040	INGOP40	C: 6.000		
XP	2+2x36	10000	61	7410	65	> 114	—	ING042	INGOP42			

CE		>80 CRI	IP67 EN 60529	230 V 2014/35/UE	50/60 Hz	IK 09 EN 60068	850° EN 60695		RG 0 EN 62471	
----	--	------------	------------------	---------------------	-------------	-------------------	------------------	--	------------------	--

**INNOVA LONG 1900**  
INNOVA LONG adatta per il relamping 1/1 di lampade a sorgente Fluo T12 con medesime dimensioni. Presa femmina per alimentazione da cablare (7PR3702-V) inclusa, lunghezza 54 mm.

INNOVA LONG suitable for 1/1 relamping of Fluo T12 lamps of the same dimensions. Female socket to be wired (7PR3702-V) included, length 54mm.

**INNOVA/P LONG 1900**  
INNOVA LONG adatta per il relamping 1/1 di lampade a sorgente Fluo T12 con medesime dimensioni. Apparecchio prolungabile completo di cavo d'alimentazione passante per trasporto d'energia 3x1,0 mm<sup>2</sup>. Connettori maschio-femmina in testata. 7PR3702-V non inclusa.

INNOVA LONG suitable for 1/1 relamping of Fluo T12 lamps of the same dimensions. Extendable luminaire complete with power through cable for energy transmission 3x1,0 mm<sup>2</sup>. Male-female connectors on end covers. 7PR3702-V not included.

LP | Temperatura ambiente min e max | Min and max room temperature: (-20° +45°)

XP  
Temperatura ambiente min e max | Min and max room temperature: (-20° +40°)

MG-TT | Temperatura ambiente min e max | Min and max room temperature: (-20° +35°)

\* Lumen nominali LED max a 25° | Nominal lumen at max 25°

\*\* Potenza dei LED | LED power

\*\*\* Flusso totale in uscita dall'apparecchio a temperatura di lavoro (Ta 25° - 4.000 K). Total lighting fitting flux output at working temperature. (Ta 25° - 4.000 K). (3.000 K -8% - CRI 90 -10%).



	DESCRIZIONE ACCESSORIO   ACCESSORY DESCRIPTION	CODICE   CODE
	<p><b>KIT FUSIBILE 10A</b> Fusibile da utilizzare in testata di alimentazione della linea a protezione del cavo di alimentazione passante (se non protetto diversamente). nella versione prolungabile protezione garantita per max 10 alimentatori.</p> <p><b>FUSE KIT 10A</b> <i>Fuse for feeding cable protection (if not otherwise protected) to be installed on end cover. For extendable version, guaranteed protection for max 10 drivers.</i></p>	<b>IN-KIT-FUSE10A</b>
	<p><b>STAFFE DI FISSAGGIO ANTIVANDOLO</b> <b>FIXING SPRINGS VANDAL PROOF</b></p>	<b>IN-MOL-AV3</b>
	<p><b>ATTACCO CLEAN</b> Per uso alimentare</p> <p><b>CLEAN CONNECTION</b> <i>For feed use</i></p>	<b>IN1900</b> <b>IN2400</b> <b>IN3000</b>
	<p><b>SENSORI INFRAROSSI</b> Kit Infrarossi sensore movimento</p> <p><b>INFRARED SENSOR</b> <i>Infrared Kit motion sensor</i></p>	<b>ININF</b>
	<p><b>SENSORE MICROONDE</b> Kit Micronde sensore movimento</p> <p><b>MICROWAVE SENSOR</b> <i>Microwave Kit motion sensor</i></p>	<b>INMIC</b>
	<p><b>SURGE PROTECTOR</b> Per sistema monofase L 155 mm <i>For a monophase system L 155 mm</i></p> <p><b>SURGE PROTECTOR</b> Per sistema trifase L 245 mm <i>For a threephase system L 245 mm</i></p>	<b>INSF1</b>  <b>INSF2</b>
	<p><b>PROLUNGA LUNGHEZZA</b> 300/600/800/1000 mm</p> <p><b>EXTENSION FOR LINE APPLICATIONS</b> <i>300/600/800/1000 mm</i></p>	<b>INHP/P/300</b> <b>INHP/P/600</b> <b>INHP/P/800</b> <b>INHP/P/1000</b>
	<p><b>PRESA FEMMINA</b> Per alimentazione da cablare (da ordinare per INNOVA/P). Lunghezza 54mm.</p> <p><b>FEMALE SOCKET</b> <i>Female socket to be wired (to be ordered for INNOVA/P) Length 54 mm.</i></p>	<b>7PR3702-V</b> (3 poli)  <b>7PR5702-V</b> (5 poli)
	<p><b>SPINA MASCHIO</b> Per alimentazione da cablare</p> <p><b>MALE PLUG</b> <i>Male plug to be wired</i></p>	<b>7PR3701</b> (3 poli)  <b>7PR5701</b> (5 poli)
	<p><b>TERMINALE</b> Chiusura file</p> <p><b>END CAP</b></p>	<b>IN-KIT-TAP</b>
	<p><b>INNESTO TUBO</b> Ø 20mm</p> <p><b>JOINT FOR RIGIDE CONDUIT</b> <i>Ø 20mm</i></p>	<b>7PR3700-C</b>

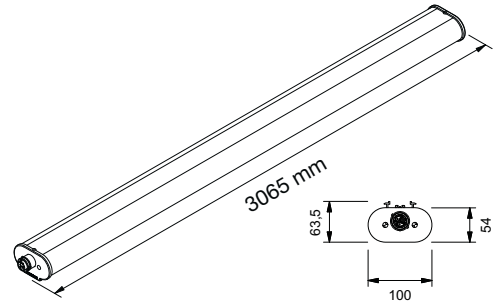

# INNOVA LONG 3000

## RIGATO/RIBBED

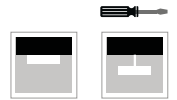

A RICHIESTA | ON REQUEST

**5Y WARRANTY**  
5% FAILURE RATE

**60.000 h**  
LED LIFETIME L90B10

**100.000 h**  
LED LIFETIME L70B50

>90  
CRI

EM  
EN 60598-2:22

DL  
DALI

PD  
PUSH DIM

WIRELESS

Relamping	Lumen LED*	Watt LED**	Lumen Out***	Watt	Lumen Watt Out	Configurazione LED LED configuration	
<b>[L] Lunghezza/Lenght - 3065 mm   Prolungabile/Extendable - 3085 mm</b>							
LP	1+1x58	8880	40	6400	43	> 149	—
TT	1+1x80	12000	64	8830	69	> 128	—
MG	2+2x49	14200	70	10380	75	> 139	—
XP	1+1x72	8170	48	6250	52	> 120	—
<b>[R] Lunghezza/Lenght - 3065 mm   Prolungabile/Extendable - 3085 mm</b>							
LP	2+2x58	17760	80	12850	86	> 149	==
TT	2+2x80	24000	128	17700	138	> 128	==
MG	4+4x49	28400	140	20750	150	> 139	==
XP	2+2x58	16000	98	11800	103	> 114	—

Codice Code	Cod. Prolungabile Extension Code	K	Alimentazione Power Supply	Schermo Diffuser
INGR2	INGRP2	W: 3.000	— : CAE	<b>rigato ribbed</b>
INGR4	INGRP4	N: 4.000	A RICHIESTA   ON REQUEST DL: DALI PD: PUSH DIM	
INGR5	INGRP5	C: 6.000		
INGR6	INGRP6			
INGR9	INGRP9	W: 3.000	— : CAE	<b>rigato ribbed</b>
INGR11	INGRP11	N: 4.000	A RICHIESTA   ON REQUEST DL: DALI PD: PUSH DIM	
INGR12	INGRP12	C: 6.000		
INGR14	INGRP14			

CE

>80  
CRI

IP67  
EN 60529

230 V  
2014/35/UE

50/60  
Hz

IK 09  
EN 60068

850°  
EN 60695

RG 0  
EN 62471

**INNOVA LONG 3000**  
**INNOVA LONG adatta per il relamping 1/1 di lampade a sorgente Fluo T12 con medesime dimensioni.** Presa femmina per alimentazione da cablare (7PR3702-V) inclusa, lunghezza 54 mm.

**INNOVA LONG suitable for 1/1 relamping of Fluo T12 lamps of the same dimensions.** Female socket to be wired (7PR3702-V) included, length 54mm.

**INNOVA/P LONG 3000**  
**INNOVA LONG adatta per il relamping 1/1 di lampade a sorgente Fluo T12 con medesime dimensioni.** Apparecchio prolungabile completo di cavo d'alimentazione passante per trasporto d'energia 3x1,0 mm<sup>2</sup>. Connettori maschio-femmina in testata. 7PR3702-V **non inclusa**.

**INNOVA LONG suitable for 1/1 relamping of Fluo T12 lamps of the same dimensions.** Extendable luminaire complete with power through cable for energy transmission 3x1,0 mm<sup>2</sup>. Male-female connectors on end covers. 7PR3702-V **not included**.

**LP** | Temperatura ambiente min e max | *Min and max room temperature:*  
**(-20° +45°)**

**XP**  
 Temperatura ambiente min e max | *Min and max room temperature:*  
**(-20° +40°)**

**MG-TT** | Temperatura ambiente min e max | *Min and max room temperature:*  
**(-20° +35°)**

\* Lumen nominali LED max a 25° | *Nominal lumen at max 25°*

\*\* Potenza dei LED | *LED power*

\*\*\* Flusso totale in uscita dall'apparecchio a temperatura di lavoro (Ta 25° - 4.000 K).  
*Total lighting fitting flux output at working temperature. (Ta 25° - 4.000 K).*  
 (3.000 K -8% - CRI 90 -10%).

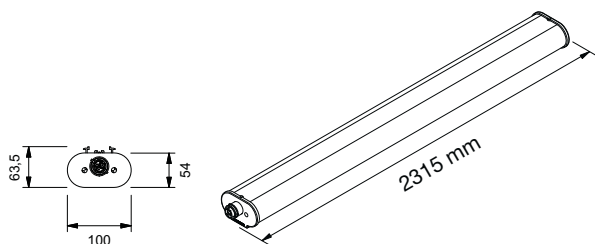

# INNOVA LONG 2400 RIGATO/RIBBED



A RICHIESTA | ON REQUEST



Relamping	Lumen LED*	Watt LED**	Lumen Out***	Watt	Lumen Watt Out	Configurazione LED LED configuration	Code Code	Cod. Prolungabile Extension Code	K	Alimentazione Power Supply	Schermo Diffuser
<b>[L] Lunghezza/Lenght - 3065 mm   Prolungabile/Extendable - 3085 mm</b>											
LP	1+1x36	6600	30	4800	32	> 149	——	INGR16	INGRP16	W: 3.000	A RICHIESTA   ON REQUEST DL: DALI PD: PUSH DIM  <b>rigato ribbed</b>
TT	1+1x54	9000	48	6640	52	> 128	——	INGR18	INGRP18	N: 4.000	
MG	2+2x28	10650	52	7800	56	> 139	——	INGR19	INGRP19	C: 6.000	
XP	1+1x50	6130	36	4688	39	> 120	——	INGR20	INGRP20		
LP	2+2x36	13320	60	9580	64	> 149	====	INGR23	INGRP23	W: 3.000	A RICHIESTA   ON REQUEST DL: DALI PD: PUSH DIM  <b>rigato ribbed</b>
TT	2+2x54	18000	96	13280	103	> 128	====	INGR25	INGRP25	N: 4.000	
MG	4+4x28	21300	104	15600	112	> 139	====	INGR26	INGRP26	C: 6.000	
XP	2+2x36	12000	72	8850	78	> 120	——	INGR28	INGRP28		



### INNOVA LONG 2400

INNOVA LONG adatta per il relamping 1/1 di lampade a sorgente Fluo T12 con medesime dimensioni. Presa femmina per alimentazione da cablare (7PR3702-V) inclusa, lunghezza 54 mm.

INNOVA LONG suitable for 1/1 relamping of Fluo T12 lamps of the same dimensions. Female socket to be wired (7PR3702-V) included, length 54mm.

### INNOVA/P LONG 2400

INNOVA LONG adatta per il relamping 1/1 di lampade a sorgente Fluo T12 con medesime dimensioni. Apparecchio prolungabile completo di cavo d'alimentazione passante per trasporto d'energia 3x1,0 mm<sup>2</sup>. Connettori maschio-femmina in testata. 7PR3702-V non inclusa.

INNOVA LONG suitable for 1/1 relamping of Fluo T12 lamps of the same dimensions. Extendable luminaire complete with power through cable for energy transmission 3x1,0 mm<sup>2</sup>. Male-female connectors on end covers. 7PR3702-V not included.

LP | Temperatura ambiente min e max | Min and max room temperature: (-20° +45°)

XP  
Temperatura ambiente min e max | Min and max room temperature: (-20° +40°)

MG-TT | Temperatura ambiente min e max | Min and max room temperature: (-20° +35°)

\* Lumen nominali LED max a 25° | Nominal lumen at max 25°

\*\* Potenza dei LED | LED power

\*\*\* Flusso totale in uscita dall'apparecchio a temperatura di lavoro (Ta 25° - 4.000 K). Total lighting fitting flux output at working temperature. (Ta 25° - 4.000 K). (3.000 K -8% - CRI 90 -10%).



Accessori | Accessories  
p. 295



Descrizione prodotto | Product description  
p. 282



Schema di cablaggio | Connection scheme  
p. XXVIII-XXIX



Fotometrie | Photometries  
p. 283

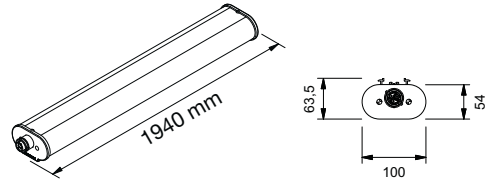

# INNOVA LONG 1900

## RIGATO/RIBBED



**5Y WARRANTY**  
5% FAILURE RATE

**60.000 h**  
LED LIFETIME L90B10

**100.000 h**  
LED LIFETIME L70B50

A RICHIESTA | ON REQUEST

>90  
CRI

EM  
EN 60598-2-22

DL  
DALI

PD  
PUSH DIM

WIRELESS

Relamping	Lumen LED*	Watt LED**	Lumen Out***	Watt	Lumen Watt Out	Configurazione LED LED configuration	
<b>[L] Lunghezza/Lenght - 1940 mm   Prolungabile/Extendable - 1960 mm</b>							
<b>LP</b>	1+1x36	<b>5500</b>	25	39,5	26,5	> 149	—
<b>TT</b>	1+1x54	<b>7500</b>	40	5440	42,5	> 128	—
<b>MG</b>	2+2x28	<b>8875</b>	43	6400	46	> 139	—
<b>XP</b>	1+1x50	<b>5100</b>	30	3850	32	> 120	—
<hr/>							
<b>LP</b>	2+2x36	<b>11100</b>	50	7970	53,5	> 149	==
<b>TT</b>	2+2x54	<b>15000</b>	80	10960	85,5	> 128	==
<b>MG</b>	4+4x28	<b>17750</b>	87,5	13000	93,5	> 139	==
<b>XP</b>	2+2x36	<b>10000</b>	61	6800	65	> 120	—

Code Code	Cod. Prolungabile Extension Code	K	Alimentazione Power Supply	Schermo Diffuser
<b>INGR30</b>	<b>INGRP30</b>	<b>W:</b> 3.000	— : CAE  A RICHIESTA   ON REQUEST <b>DL:</b> DALI <b>PD:</b> PUSH DIM	<b>rigato ribbed</b>
<b>INGR32</b>	<b>INGRP32</b>	<b>N:</b> 4.000		
<b>INGR33</b>	<b>INGRP33</b>	<b>C:</b> 6.000		
<b>INGR34</b>	<b>INGRP34</b>			
<b>INGR37</b>	<b>INGRP37</b>	<b>W:</b> 3.000	— : CAE  A RICHIESTA   ON REQUEST <b>DL:</b> DALI <b>PD:</b> PUSH DIM	<b>rigato ribbed</b>
<b>INGR39</b>	<b>INGRP39</b>	<b>N:</b> 4.000		
<b>INGR40</b>	<b>INGRP40</b>	<b>C:</b> 6.000		
<b>INGR42</b>	<b>INGRP42</b>			

CE

>80  
CRI

**IP67**  
EN 60529

**230 V**  
2014/35/UE

**50/60**  
Hz

**IK 09**  
EN 60068

**850°**  
EN 60695

A++  
A+  
A

**RG 0**  
EN 62471

**INNOVA LONG 1900**  
**INNOVA LONG adatta per il relamping 1/1 di lampade a sorgente Fluo T12 con medesime dimensioni.** Presa femmina per alimentazione da cablare (7PR3702-V) inclusa, lunghezza 54 mm.

**INNOVA LONG suitable for 1/1 relamping of Fluo T12 lamps of the same dimensions.** Female socket to be wired (7PR3702-V) included, length 54mm.

**INNOVA/P LONG 1900**  
**INNOVA LONG adatta per il relamping 1/1 di lampade a sorgente Fluo T12 con medesime dimensioni.** Apparecchio prolungabile completo di cavo d'alimentazione passante per trasporto d'energia 3x1,0 mm<sup>2</sup>. Connettori maschio-femmina in testata. 7PR3702-V **non inclusa**.

**INNOVA LONG suitable for 1/1 relamping of Fluo T12 lamps of the same dimensions.** Extendable luminaire complete with power through cable for energy transmission 3x1,0 mm<sup>2</sup>. Male-female connectors on end covers. 7PR3702-V **not included**.

**LP** | Temperatura ambiente min e max | *Min and max room temperature:*  
**(-20° +45°)**

**XP**  
 Temperatura ambiente min e max | *Min and max room temperature:*  
**(-20° +40°)**

**MG-TT** | Temperatura ambiente min e max | *Min and max room temperature:*  
**(-20° +35°)**

\* Lumen nominali LED max a 25° | *Nominal lumen at max 25°*

\*\* Potenza dei LED | *LED power*

\*\*\* Flusso totale in uscita dall'apparecchio a temperatura di lavoro (Ta 25° - 4.000 K).  
*Total lighting fitting flux output at working temperature. (Ta 25° - 4.000 K).*  
 (3.000 K -8% - CRI 90 -10%).

	DESCRIZIONE ACCESSORIO   ACCESSORY DESCRIPTION	CODICE   CODE
	<p><b>KIT FUSIBILE 10A</b> Fusibile da utilizzare in testata di alimentazione della linea a protezione del cavo di alimentazione passante (se non protetto diversamente). nella versione prolungabile protezione garantita per max 10 alimentatori.</p> <p><b>FUSE KIT 10A</b> <i>Fuse for feeding cable protection (if not otherwise protected) to be installed on end cover. For extendable version, guaranteed protection for max 10 drivers.</i></p>	<b>IN-KIT-FUSE10A</b>
	<p><b>STAFFE DI FISSAGGIO ANTIVANDOLO</b> <b>FIXING SPRINGS VANDAL PROOF</b></p>	<b>IN-MOL-AV3</b>
	<p><b>ATTACCO CLEAN</b> Per uso alimentare</p> <p><b>CLEAN CONNECTION</b> <i>For feed use</i></p>	<b>IN1900</b> <b>IN2400</b> <b>IN3000</b>
	<p><b>SENSORI INFRAROSSI</b> Kit Infrarossi sensore movimento</p> <p><b>INFRARED SENSOR</b> <i>Infrared Kit motion sensor</i></p>	<b>ININF</b>
	<p><b>SENSORE MICROONDE</b> Kit Micronde sensore movimento</p> <p><b>MICROWAVE SENSOR</b> <i>Microwave Kit motion sensor</i></p>	<b>INMIC</b>
	<p><b>SURGE PROTECTOR</b> Per sistema monofase L 155 mm <i>For a monophase system L 155 mm</i></p> <p><b>SURGE PROTECTOR</b> Per sistema trifase L 245 mm <i>For a threephase system L 245 mm</i></p>	<b>INSF1</b>  <b>INSF2</b>
	<p><b>PROLUNGA LUNGHEZZA</b> 300/600/800/1000 mm</p> <p><b>EXTENSION FOR LINE APPLICATIONS</b> <i>300/600/800/1000 mm</i></p>	<b>INHP/P/300</b> <b>INHP/P/600</b> <b>INHP/P/800</b> <b>INHP/P/1000</b>
	<p><b>PRESA FEMMINA</b> Per alimentazione da cablare (da ordinare per INNOVA/P). Lunghezza 54mm.</p> <p><b>FEMALE SOCKET</b> <i>Female socket to be wired (to be ordered for INNOVA/P)</i> <i>Length 54 mm.</i></p>	<b>7PR3702-V</b> (3 poli)  <b>7PR5702-V</b> (5 poli)
	<p><b>SPINA MASCHIO</b> Per alimentazione da cablare</p> <p><b>MALE PLUG</b> <i>Male plug to be wired</i></p>	<b>7PR3701</b> (3 poli)  <b>7PR5701</b> (5 poli)
	<p><b>TERMINALE</b> Chiusura file</p> <p><b>END CAP</b></p>	<b>IN-KIT-TAP</b>
	<p><b>INNESTO TUBO</b> Ø 20mm</p> <p><b>JOINT FOR RIGIDE CONDUIT</b> <i>Ø 20mm</i></p>	<b>7PR3700-C</b>

# GAMMA PRODOTTI | PRODUCT RANGE

## INNOVA UT



### INNOVA UT (1500-1200) SATINATO/SATIN

p. 298

Corpo unico in policarbonato coestruso satinato ad elevata resistenza meccanica protetto ai raggi UV, a mezzo di coostrusione JEDEX. Riflettore interno in alluminio con funzione di dissipatore. Testate di chiusura in policarbonato stampato. Sistema di fissaggio a sospensione. Sorgente luminosa LED. Emissione diretta. Non idonea per applicazioni esterne. Alimentazione elettronica CAE. A richiesta: dimmerabile DALI (cod. DL) specificare se con funzione PUSH DIM (cod. PD).

*One piece body made of coextruded satin polycarbonate with high mechanical resistance UV-resistant (anti UV system named JEDEX). Internal louver with heat sink function. Polycarbonate endcaps. Suspension fixing system. LED light source. Direct light emission. Not suitable for outdoor application. Built in electronic driver CAE. On request: dimmable DALI (code DL) PUSH DIM function (code PD) to be requested.*



### INNOVA UT (1500-1200) OPALE/OPAL

p. 299

Corpo unico in policarbonato coestruso opale ad elevata resistenza meccanica protetto ai raggi UV, a mezzo di coostrusione JEDEX. Riflettore interno in alluminio con funzione di dissipatore. Testate di chiusura in policarbonato stampato. Sistema di fissaggio a sospensione. Sorgente luminosa LED. Emissione diretta. Non idonea per applicazioni esterne. Alimentazione elettronica CAE. A richiesta: dimmerabile DALI (cod. DL) specificare se con funzione PUSH DIM (cod. PD).

*One piece body made of coextruded opal polycarbonate with high mechanical resistance UV-resistant (anti UV system named JEDEX). Internal louver with heat sink function. Polycarbonate endcaps. Suspension fixing system. LED light source. Direct light emission. Not suitable for outdoor application. Built in electronic driver CAE. On request: dimmable DALI (code DL) PUSH DIM function (code PD) to be requested.*



# FOTOMETRIE | PHOTOMETRIES

## INNOVA UT

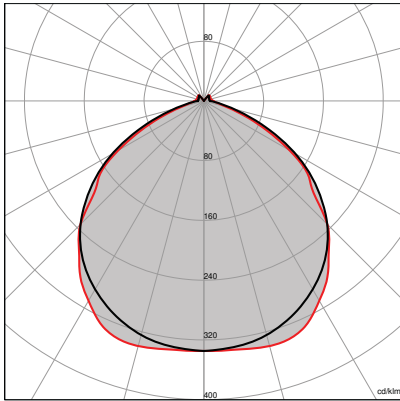

**INNOVA UT**  
SATINATO/SATIN

UT

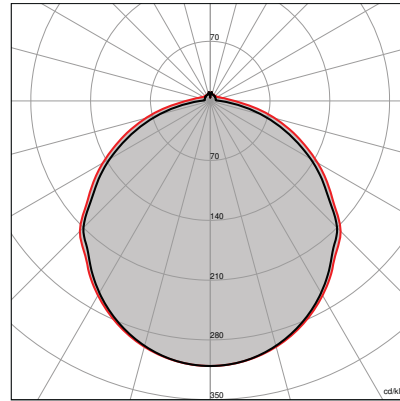

**INNOVA UT**  
OPALE/OPAL

UT



Rimani aggiornato  
Keep up to date

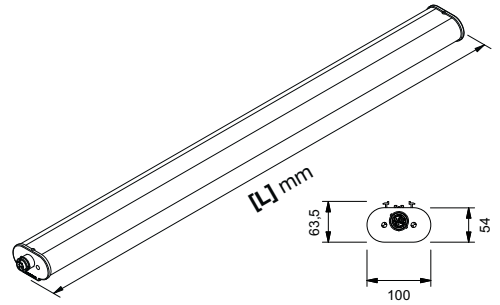

# INNOVA UT SATINATO/SATIN



A RICHIESTA | ON REQUEST

<b>5Y WARRANTY</b> 5% FAILURE RATE	<b>60.000 h</b> LED LIFETIME <b>L90B10</b>	<b>100.000 h</b> LED LIFETIME <b>L70B50</b>
---------------------------------------	---	--

>90 CRI	EM EN 60598-2-22	DL DALI	PD PUSH DIM	WIRELESS	⚡
------------	---------------------	------------	----------------	----------	---

Relamping	Lumen LED*	Watt LED**	Lumen Out***	Watt	Lumen Watt Out	Configurazione LED LED configuration	Codice Code	K	Alimentazione Power Supply	Schermo Diffuser
<b>[L] Lunghezza/Length - 1565 mm</b>										
UT	1X58	<b>4090</b>	22	3280	24	> 137	————	<b>INUT15</b>	<b>W:</b> 3.000 <b>N:</b> 4.000 <b>C:</b> 6.000 — : CAE A RICHIESTA   ON REQUEST <b>DL:</b> DALI <b>PD:</b> PUSH DIM	<b> satinato satin</b>
UT	1X80	<b>6240</b>	33,5	4935	36	> 137	————	<b>INUT17</b>		
UT	2X58	<b>8000</b>	49	6240	52	> 120	————	<b>INUT19</b>		
UT	2X80	<b>11200</b>	69	8880	74	>120	————	<b>INUT21</b>		
<b>[L] Lunghezza/Length - 1190 mm</b>										
UT	1x36	<b>3070</b>	16,5	2390	18	> 137	————	<b>INUT26</b>	<b>W:</b> 3.000 <b>N:</b> 4.000 <b>C:</b> 6.000 — : CAE A RICHIESTA   ON REQUEST <b>DL:</b> DALI <b>PD:</b> PUSH DIM	<b> satinato satin</b>
UT	1x58	<b>4680</b>	25	3700	27	> 137	————	<b>INUT37</b>		
UT	2x36	<b>6400</b>	41	4900	41	> 120	————	<b>INUT40</b>		
UT	2x58	<b>8400</b>	48,5	6200	52	> 120	————	<b>INUT51</b>		

CE	⊕	>80 CRI	IP67 EN 60529	230 V 2014/35/UE	50/60 Hz	IK 09 EN 60068	850° EN 60695	A++ A+ A	RG 0 EN 62471	🏠
----	---	------------	------------------	---------------------	-------------	-------------------	------------------	----------------	------------------	---

**INNOVA UT 1500 - 1200**  
 Presa femmina per alimentazione da cablare (7PR3702-V) **inclusa**, lunghezza 54 mm.  
 Female socket to be wired (7PR3702-V) **included**, length 54 mm.

**UT** | Temperatura ambiente min e max | *Min and max room temperature:*  
**(-20° +40°)**

\* Lumen nominali LED max a 25° | *Nominal lumen at max 25°*  
 \*\* Potenza dei LED | *LED power*  
 \*\*\* Flusso totale in uscita dall'apparecchio a temperatura di lavoro (Ta 25° - 4.000 K).  
*Total lighting fitting flux output at working temperature (Ta 25° - 4.000 K).*  
 (3.000 K -8% - CRI 90 -10%).



Fotometrie | *Photometries*  
 p. 297



Schema di cablaggio | *Connection scheme*  
 p. XXVIII-XXIX



Descrizione prodotto | *Product description*  
 p. 296



Accessori | *Accessories*  
 p. 295

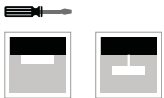
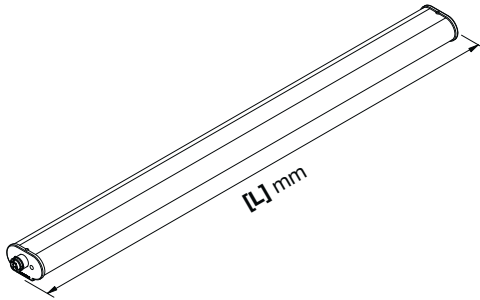
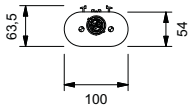

# INNOVA UT OPALE/OPAL

A RICHIESTA | ON REQUEST



<b>5Y WARRANTY</b> 5% FAILURE RATE	<b>60.000 h</b> LED LIFETIME L90B10	<b>100.000 h</b> LED LIFETIME L70B50
---------------------------------------	--	---

Relamping	Lumen LED*	Watt LED**	Lumen Out***	Watt	Lumen Watt Out	Configurazione LED LED configuration	Codice Code	K	Alimentazione Power Supply	Schermo Diffuser
<b>[L] Lunghezza/Length - 1565 mm</b>										
UT	1X58	4090	22	3120	24	> 130	_____	INUTO15	<b>W:</b> 3.000 <b>N:</b> 4.000 <b>C:</b> 6.000 --- : CAE A RICHIESTA   ON REQUEST <b>DL:</b> DALI <b>PD:</b> PUSH DIM	opale opal
UT	1X80	6240	33,5	4680	36	> 130	_____	INUTO17		
UT	2X58	8000	49	5928	52	> 114	_____	INUTO19		
UT	2X80	11200	69	8440	74	>114	_____	INUTO21		
<b>[L] Lunghezza/Length - 1190 mm</b>										
UT	1X36	3070	16,5	2340	18	> 130	_____	INUTO26	<b>W:</b> 3.000 <b>N:</b> 4.000 <b>C:</b> 6.000 --- : CAE A RICHIESTA   ON REQUEST <b>DL:</b> DALI <b>PD:</b> PUSH DIM	opale opal
UT	1X58	4680	25	3510	27	> 130	_____	INUTO37		
UT	2x36	6400	41	4680	41	> 114	_____	INUTO40		
UT	2x58	8400	48,5	5925	52	> 114	_____	INUTO51		



**INNOVA UT 1500 - 1200**

Presse femmina per alimentazione da cablare (7PR3702-V) **inclusa**, lunghezza 54 mm.

Female socket to be wired (7PR3702-V) **included**, length 54 mm.

UT | Temperatura ambiente min e max | *Min and max room temperature:*  
**(-20° +40°)**

\* Lumen nominali LED max a 25° | *Nominal lumen at max 25°*

\*\* Potenza dei LED | *LED power*

\*\*\* Flusso totale in uscita dall'apparecchio a temperatura di lavoro (Ta 25° - 4.000 K).  
*Total lighting fitting flux output at working temperature (Ta 25° - 4.000 K).*  
(3.000 K -8% - CRI 90 -10%).



Accessori | Accessories  
p. 295



Descrizione prodotto | Product description  
p. 296



Schema di cablaggio | Connection scheme  
p. XXVIII-XXIX



Fotometrie | Photometries  
p. 297

# GAMMA PRODOTTI | PRODUCT RANGE

## INNOVA BASSO VOLTAGGIO • INNOVA LOW VOLTAGE



### INNOVA 110V (1500-1200-600) SATINATO/SATIN

p. 302

Corpo unico in policarbonato coestruso satinato ad elevata resistenza meccanica protetto ai raggi UV, a mezzo di coostrusione JEDEX. Riflettore interno in alluminio con funzione di dissipatore. Testate di chiusura in policarbonato stampato. Sistema di fissaggio a sospensione. Sorgente luminosa LED. Emissione diretta. Non idonea per applicazioni esterne. Alimentazione elettronica CAE.

*One piece body made of coextruded satin polycarbonate with high mechanical resistance UV-resistant (anti UV system named JEDEX). Internal louver with heat sink function. Polycarbonate endcaps. Suspension fixing system. LED light source. Direct light emission. Not suitable for outdoor application. Built in electronic driver CAE.*



### INNOVA 48V (1500-1200-400) SATINATO/SATIN

p. 303

Corpo unico in policarbonato coestruso satinato ad elevata resistenza meccanica protetto ai raggi UV, a mezzo di coostrusione JEDEX. Riflettore interno in alluminio con funzione di dissipatore. Testate di chiusura in policarbonato stampato. Sistema di fissaggio a sospensione. Sorgente luminosa LED. Emissione diretta. Non idonea per applicazioni esterne. Alimentazione elettronica CAE.

*One piece body made of coextruded satin polycarbonate with high mechanical resistance UV-resistant (anti UV system named JEDEX). Internal louver with heat sink function. Polycarbonate endcaps. Suspension fixing system. LED light source. Direct light emission. Not suitable for outdoor application. Built in electronic driver CAE.*



### INNOVA 24V (1500-1200-400) SATINATO/SATIN

p. 304

Corpo unico in policarbonato coestruso satinato ad elevata resistenza meccanica protetto ai raggi UV, a mezzo di coostrusione JEDEX. Riflettore interno in alluminio con funzione di dissipatore. Testate di chiusura in policarbonato stampato. Sistema di fissaggio a sospensione. Sorgente luminosa LED. Emissione diretta. Non idonea per applicazioni esterne. Alimentazione elettronica CAE.

*One piece body made of coextruded satin polycarbonate with high mechanical resistance UV-resistant (anti UV system named JEDEX). Internal louver with heat sink function. Polycarbonate endcaps. Suspension fixing system. LED light source. Direct light emission. Not suitable for outdoor application. Built in electronic driver CAE.*

# FOTOMETRIE | PHOTOMETRIES

INNOVA BASSO VOLTAGGIO • INNOVA LOW VOLTAGE

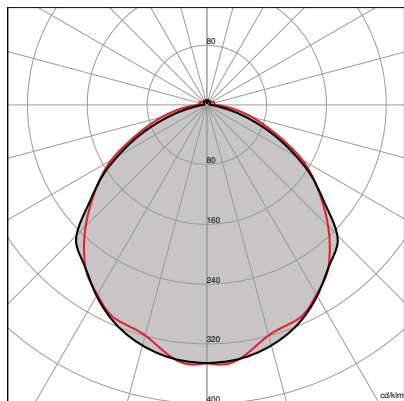

**INNOVA 110 V**  
SATINATO/SATIN

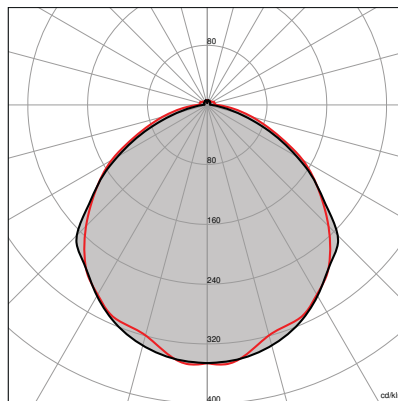

**INNOVA 48 V**  
SATINATO/SATIN

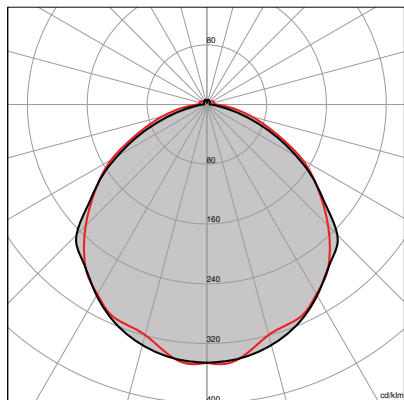

**INNOVA 24 V**  
SATINATO/SATIN



Rimani aggiornato  
Keep up to date



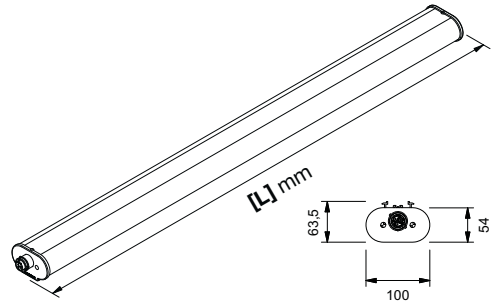

# INNOVA 110V ac/dc SATINATO/SATIN



A RICHIESTA | ON REQUEST

**5Y WARRANTY**  
5% FAILURE RATE

**60.000 h**  
LED LIFETIME L90B10

**100.000 h**  
LED LIFETIME L70B50

**>90**  
CRI

Relamping	Lumen LED*	Watt LED**	Lumen Out***	Watt	Lumen Watt Out	Configurazione LED LED configuration	Codice Code	K	Alimentazione Power Supply	Schermo Diffuser
<b>[L] Lunghezza/Length - 1565 mm</b>										
1X58	<b>3860</b>	25	3080	27,5	> 110	—	<b>INSH1101</b>	<b>W:</b> 3.000	— : CAE	<b>satinato satin</b>
2X58	<b>7729</b>	50	6180	55	> 110	==	<b>INSH1102</b>	<b>N:</b> 4.000 <b>C:</b> 6.000		
<b>[L] Lunghezza/Length - 1190 mm</b>										
1X36	<b>2895</b>	19	2300	21	> 110	—	<b>INSH1103</b>	<b>W:</b> 3.000	— : CAE	<b>satinato satin</b>
2X36	<b>5790</b>	38	4600	42	> 110	==	<b>INSH1104</b>	<b>N:</b> 4.000 <b>C:</b> 6.000		
<b>[L] Lunghezza/Length - 645 mm</b>										
1X36	<b>1930</b>	13	1540	14	> 110	—	<b>INSH1105</b>	<b>W:</b> 3.000	— : CAE	<b>satinato satin</b>
1X58	<b>3860</b>	25	3080	27,5	> 110	==	<b>INSH1106</b>	<b>N:</b> 4.000 <b>C:</b> 6.000		



**INNOVA 110 V ac/dc**  
Plafoniera stagna a LED con temperatura d'esercizio **-20°C +40°C**. Presa femmina per alimentazione da cablare (7PR3702-V) **inclusa**, lunghezza 54 mm.

**Corrosion-proof LED lighting fittings for operating temperatures -20°C +40°C**. Female socket to be wired (7PR3702-V) **included**, length 54mm.

Temperatura ambiente min e max | *Min and max room temperature:*  
**(-20° +40°)**

\* Lumen nominali LED max a 25° | *Nominal lumen at max 25°*

\*\* Potenza dei LED | *LED power*

\*\*\* Flusso totale in uscita dall'apparecchio a temperatura di lavoro (Ta 25° - 4.000 K).  
*Total lighting fitting flux output at working temperature. (Ta 25° - 4.000 K).*  
(3.000 K -8% - CRI 90 -10%).

Fotometrie | *Photometries*  
p. 301

Schema di cablaggio | *Connection scheme*  
p. XXVIII-XXIX

Descrizione prodotto | *Product description*  
p. 300



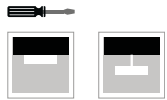
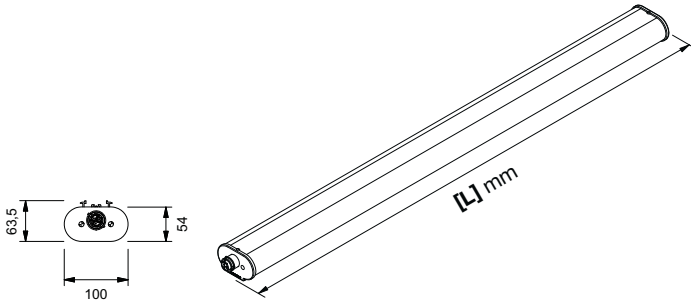

# INNOVA 48V ac/dc SATINATO/SATIN

A RICHIESTA | ON REQUEST

>90  
CRI

**5Y WARRANTY**  
5% FAILURE RATE

**60.000 h**  
LED LIFETIME L90B10

**100.000 h**  
LED LIFETIME L70B50

Relamping	Lumen LED*	Watt LED**	Lumen Out***	Watt	Lumen Watt Out	Configurazione LED LED configuration	Codice Code	K	Alimentazione Power Supply	Schermo Diffuser
<b>[L] Lunghezza/Lenght - 1565 mm</b>										
1X58	<b>3860</b>	25	3080	27,5	> 110	—	<b>INSH481</b>	W: 3.000	— : CAE	satinato satin
2X58	<b>7720</b>	50	6180	55	> 110	==	<b>INSH482</b>	N: 4.000 C: 6.000		
<b>[L] Lunghezza/Lenght - 1190 mm</b>										
1X36	<b>2895</b>	19	2300	21	> 110	—	<b>INSH483</b>	W: 3.000	— : CAE	satinato satin
2X36	<b>5790</b>	38	4600	42	> 110	==	<b>INSH484</b>	N: 4.000 C: 6.000		
<b>[L] Lunghezza/Lenght - 440 mm</b>										
1X18	<b>965</b>	6,5	770	7	> 110	—	<b>INSH485</b>	W: 3.000	— : CAE	satinato satin
2X18	<b>1930</b>	13	1540	14	> 110	==	<b>INSH486</b>	N: 4.000 C: 6.000		



**INNOVA 48 V ac/dc**  
Plafoniera stagna a LED con temperatura d'esercizio **-20°C +40°C**. Presa femmina per alimentazione da cablare (7PR3702-V) **inclusa**, lunghezza 54 mm.

**Corrosion-proof LED lighting fittings for operating temperatures -20°C +40°C. Female socket to be wired (7PR3702-V) included, length 54mm.**

Temperatura ambiente min e max | *Min and max room temperature:*  
**(-20° +40°)**

\* Lumen nominali LED max a 25° | *Nominal lumen at max 25°*  
\*\* Potenza dei LED | *LED power*  
\*\*\* Flusso totale in uscita dall'apparecchio a temperatura di lavoro (Ta 25° - 4.000 K).  
*Total lighting fitting flux output at working temperature. (Ta 25° - 4.000 K).*  
(3.000 K -8% - CRI 90 -10%).

Descrizione prodotto | *Product description*  
p. 300

Schema di cablaggio | *Connection scheme*  
p. XXVIII-XXIX

Fotometrie | *Photometries*  
p. 301

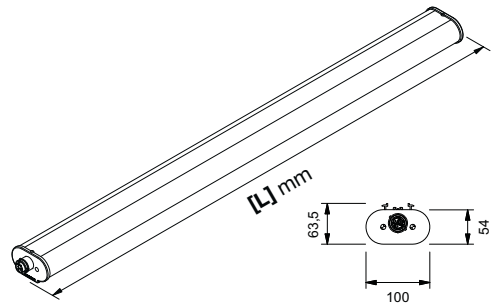

# INNOVA 24V ac/dc SATINATO/SATIN



**R A R I C H I E S T A | O N R E Q U E S T**

**>90**  
CRI

<b>5Y WARRANTY</b> 5% FAILURE RATE	<b>60.000 h</b> LED LIFETIME L90B10	<b>100.000 h</b> LED LIFETIME L70B50
---------------------------------------	--	---

Relamping	Lumen LED*	Watt LED**	Lumen Out***	Watt	Lumen Watt Out	Configurazione LED LED configuration	Codice Code	K	Alimentazione Power Supply	Schermo Diffuser
<b>[L] Lunghezza/Lenght - 1565 mm</b>										
1X58	<b>3860</b>	25	3080	27,5	> 110	—	<b>INSH241</b>	W: 3.000 N: 4.000 C: 6.000	— : CAE	<b>satinato</b> <i>satın</i>
<b>[L] Lunghezza/Lenght - 1190 mm</b>										
1X36	<b>2895</b>	19	2300	21	> 110	—	<b>INSH242</b>	W: 3.000 N: 4.000 C: 6.000	— : CAE	<b>satinato</b> <i>satın</i>
<b>[L] Lunghezza/Lenght - 440 mm</b>										
1X18	<b>965</b>	6,5	770	7	> 110	—	<b>INSH243</b>	W: 3.000 N: 4.000 C: 6.000	— : CAE	<b>satinato</b> <i>satın</i>
2X18	<b>1930</b>	13	1540	14,5	> 110	==	<b>INSH244</b>	W: 3.000 N: 4.000 C: 6.000	— : CAE	<b>satinato</b> <i>satın</i>

		<b>&gt;80</b> CRI	<b>IP67</b> EN 60529	<b>24 V</b> 2014/35/UE	<b>0/50/60</b> Hz	<b>IK 09</b> EN 60068	<b>850°</b> EN 60695		<b>RG 0</b> EN 62471	
--	--	----------------------	-------------------------	---------------------------	----------------------	--------------------------	-------------------------	--	-------------------------	--

**INNOVA 110 V ac/dc**  
Plafoniera stagna a LED con temperatura d'esercizio **-20°C +40°C**. Presa femmina per alimentazione da cablare (7PR3702-V) **inclusa**, lunghezza 54 mm.

**Corrosion-proof LED lighting fittings for operating temperatures -20°C +40°C.** Female socket to be wired (7PR3702-V) **included**, length 54mm.

Temperatura ambiente min e max | *Min and max room temperature:*  
**(-20° +40°)**

\* Lumen nominali LED max a 25° | *Nominal lumen at max 25°*

\*\* Potenza dei LED | *LED power*

\*\*\* Flusso totale in uscita dall'apparecchio a temperatura di lavoro (Ta 25° - 4.000 K).  
*Total lighting fitting flux output at working temperature (Ta 25° - 4.000 K).*  
(3.000 K -8% - CRI 90 -10%).

Fotometrie | *Photometries*  
p. 301

Schema di cablaggio | *Connection scheme*  
p. XXVIII-XXIX

Descrizione prodotto | *Product description*  
p. 300



LABORATORIO ANALISI | *LABORATORY ANALYSIS* | ITALIA



SUPERMERCATO | *SUPERMARKET* | SOGEGROSS | GENOVA



SUPERMERCATO | *SUPERMARKET* | SOGEGROSS | GENOVA



PALESTRA | *SPORT CENTER* | LUSSEMBURGO



SUPERMERCATO | *SUPERMARKET* | SOGEGROSS | GENOVA



SUPERMERCATO | *SUPERMARKET* | SOGEGROSS | GENOVA

DESCRIZIONE ACCESSORIO  
ACCESSORY DESCRIPTIONCODICE  
CODE**SENSORI INFRAROSSI**

Kit Infrarossi sensore movimento

**ININF****INFRARED SENSOR**

Infrared Kit motion sensor

**IT**

Questo dispositivo è in grado di catturare le emissioni infrarosse invisibili da qualsiasi fonte di calore senza emettere alcuna radiazione. Il rivelatore darà il comando ON quando una sorgente di calore si muove di fronte al sensore e si spegne in mancanza di cattura del movimento, dopo un tempo di ritardo regolabile. **Possibilità' di integrare il sensore nell'apparecchio - modalità "stand alone".**

**Caratteristiche:**

Tempo apparecchio ON: min.5 secondi max 8 minuti.  
 Settaggio luminosità ambiente minima d'intervento: sempre attivo.  
 Angolo rilevamento: 360°.  
 Cono rilevamento: 120°.  
 Distanza massima di rilevamento impostabile: 8m.  
 Carico massimo ammissibile: 500W.

**EN**

***This device is able to capture invisible infrared emissions from any heat source without emitting any radiation.***

*The detector gives ON command when a heat source moves in front of the sensor and it switches off when there is no movement detected after the adjustable delay time. **Possibility to integrate the sensor into the fixture - "stand alone" mode.***

**Characteristics:**

*Fixture time ON: min. 5 seconds max 8 minutes.  
 Minimum for intervention area illumination setting: always active.  
 Angle detection: 360C.  
 Cone detection: 120C.  
 Adjustable detection distance: 8m.  
 Maximum acceptable power: 500W.*

DESCRIZIONE ACCESSORIO  
ACCESSORY DESCRIPTIONCODICE  
CODE**SENSORE MICROONDE**

Kit Micronde sensore movimento

**INMIC****MICROWAVE SENSOR**

Microwave Kit motion sensor

**IT**

**Rilevamento presenza con tecnologia a onde elettromagnetiche ad alta frequenza.**

Il sensore emette onde elettromagnetiche e riceve il loro eco; analizzandolo è in grado di riconoscere eventuali variazioni generate da un oggetto non rilevato nella precedente analisi e trasmettere l'informazione ad un microprocessore che darà il comando ON all'apparecchio di illuminazione. Adatto in tutti gli ambienti dove i sensori con tecnologia ad infrarossi non consente il corretto funzionamento, come ad esempio celle frigorifere, magazzini e/o locali freddi dove l'abbigliamento del personale non consente il rilevamento della temperatura corporea.

**Caratteristiche:**

Tempo apparecchio ON: min.10 secondi max 30 minuti.  
 Settaggio luminosità ambiente minima d'intervento: min. 10lux max 500lux.  
 Angolo rilevamento: 360°.  
 Cono rilevamento: regolabile in funzione della distanza di rilevamento richiesta.  
 Distanza massima di rilevamento impostabile: 2-10m.  
 Carico massimo ammissibile: 800W.

**EN**

***Presence detection with a high frequency electromagnetic wave technology.***

*The sensor emits electromagnetic waves and receives their echo; while analyzing it, it is able to identify possible variations generated by an object, which was not detected in the previous analysis and transmits the information to a microprocessor, which will give the command ON to the lighting fixture. It is suitable in every environment where sensors with infrared technology do not allow correct functioning, as, for instance, in refrigerator chambers, warehouses and/or cold rooms where the clothes of the staff do not allow to detect body temperature.*

**Characteristics:**

*Fixture time ON: min. 10 seconds max 30 minutes.  
 Minimum for intervention area illumination setting: min. 10lux max 500lux.  
 Angle detection: 360C.  
 Cone detection: adjustable according to the required distance of detection.  
 Adjustable maximum detection distance: 2-10m. Maximum acceptable power: 800W.*

	DESCRIZIONE ACCESSORIO ACCESSORY DESCRIPTION	CODICE CODE
	<b>SURGE PROTECTOR</b> Per sistema monofase L 155 mm <i>For a monophase system L 155 mm</i>	<b>INSF1</b>
	<b>SURGE PROTECTOR</b> Per sistema trifase L 245 mm <i>For a threephase system L 245 mm</i>	<b>INSF2</b>

**IT**

La richiesta di apparecchi sempre più efficienti, compatti e con aspettative di vita elevate, è resa possibile dall'utilizzo di alimentatori elettronici sempre più efficaci e ridotti.

Rispetto a quanto in uso fino a pochi anni fa, i componenti attuali sono realizzati con tecnologie all'avanguardia che consentono di rispettare le funzionalità richieste, ma risultando vulnerabili a condizioni particolari di utilizzo che non causavano anomalie con le tecnologie tradizionali.

Non essendo necessario in passato prevedere protezioni o sistemi particolari di gestione e stabilizzazione dell'energia, gli impianti di illuminazione presenti sul territorio sono spesso inglobati in installazioni elettriche realizzate senza considerare l'evoluzione e l'utilizzo di apparecchi con elettronica evoluta.

Infatti, sugli impianti elettrici tradizionali è possibile che si generino sovratensioni impulsive di brevissima durata che sono la causa più frequente di guasto per gli alimentatori elettronici.

La causa di queste anomalie elettriche è spesso riconducibile alla commutazione di interruttori di manovra che controllano l'alimentazione di installazioni con un importante assorbimento di corrente, oppure come conseguenza delle correnti di spunto di motori elettrici (utilizzate all'avviamento per vincere la forza di inerzia che ne contrasta la partenza), l'utilizzo di blindosbarre o canali elettrificati per la distribuzione dell'energia può causare interferenze tra i conduttori, ecc...

Con il termine surge (o spike) si identificano appunto questi picchi di tensione e breve durata, tipicamente da pochi millisecondi a 100 ms e oltre. Tali surge attraversano il fusibile, che non fonde, e si riversano sulle apparecchiature elettroniche. Il livello di tensione misurato può raggiungere 4 kV e oltre. Sulle apparecchiature elettroniche non protette contro questo tipo di fenomeno, i surge sono in grado di causare forti danni.

Questo fenomeno può essere limitato mediante l'installazione di dispositivi di protezione dalle sovratensioni (SPD - Surge Protective Device) che sono progettati per proteggere i sistemi e le apparecchiature elettriche contro le sovratensioni transitorie e impulsive. Senza un adeguato SPD di protezione, la sovratensione potrebbe raggiungere l'apparecchio di illuminazione, e nel caso in cui essa superi il valore di tenuta all'impulso dell'alimentatore elettronico, l'isolamento dell'apparecchio verrebbe meno e la corrente impulsiva si propagherebbe liberamente attraverso di essa, danneggiandola o addirittura distruggendola.

Per la protezione degli apparecchi di illuminazione in impianti dove non sono presenti altri dispositivi di controllo e stabilizzazione di questi fenomeni, proponiamo l'installazione di un accessorio adatto a eliminare questi fenomeni con protezione fino a 10kV e 5kA.

Ad esempio, applicando il dispositivo ad inizio linea saranno protetti tutti gli apparecchi a valle dell' SPD che in caso di intervento, interromperà l'alimentazione agli apparecchi salvaguardandoli da guasto; il funzionamento della linea sarà riattivato sostituendo il dispositivo danneggiato.

**EN**

The requirement to have more efficient, compact fixtures with longer life expectancy is made possible by using more efficient and smaller electronic drivers.

In comparison with earlier years, recent electronic components are produced with modern technologies, which perform requested functions but remain quite vulnerable in particular operating conditions, which did not cause any problems with traditional technologies.

It was not necessary in the past to provide protections or particular energy management or stabilization systems, lighting systems which can be found in the area are always incorporated into electrical installations created without considering evolution and the use of fixtures with advanced electronics.

Actually, overvoltage surges are probable to take place in traditional electrical plants and they are the most common cause of electronic driver failure.

The cause of these electrical anomalies is often attributed to the commutation of break switches, which control the power of installations with an important current absorption, or, as a result, inrush currents of electrical engines (used at the start to win inertial force which counteracts the start), bus bars or electrified canals used for energy distribution may cause interferences in the work of conductors, etc...

The term surge (or spike) is used to identify these short voltage peaks, which typically last from some milliseconds to 100 ms or more. These surges go through the fuse that does not burn off and they run into electronic fixtures. The measured voltage level can reach 4 kV or more. In electronic fixtures, which are not protected against this phenomenon, surges can cause serious damage.

This phenomenon can be decreased through the installation of Surge Protective Devices (SPD) which are aimed at protecting electrical systems and fixtures against transient and impulsive surges. Without an adequate SPD, the surge could reach the lighting fixture and in case it should exceed electronic driver impulse proof value, fixture isolation would decrease and surge current would spread freely through it, thus causing damage, or even destroying it.

In order to protect lighting fixtures in the plants where there are no other control and stabilization devices used for these phenomena, we offer the installation of the accessory aimed at eliminating these phenomena with the protection up to 10kV and 5kV.

For instance, when using the device at the beginning of the row, all the fixtures downstream the SPD are protected, which in case of intervention, will stop the power supply to the fixtures, thus protecting them from breakdown; line operation will be resumed by replacing the damaged device.

IT

**GESTIONE DELLA LUCE INTELLINGENTE**

Ideallux® ha sviluppato un'ampia serie di accessori per le varie esigenze di installazione.

Sensori di presenza e luminosità e una corretta programmazione del sistema per un'illuminazione migliore con il massimo risparmio energetico.

La consolidata esperienza di IDEALLUX è messa a disposizione per studiare soluzioni per la realizzazione di impianti "intelligenti", in grado di ottimizzare l'utilizzo dell'illuminazione al fine di ottenere impianti efficienti senza trascurare le esigenze illuminotecniche; questo obiettivo è per noi tradotto come minor consumo di energia con la massima efficienza dell'impianto di illuminazione. L'esperienza acquisita sul campo ci suggerisce di non proporre una soluzione universale per questo tipo di installazioni, ma di proporci come partner per lo studio di una soluzione adatta al tipo di ambienti da illuminare; infatti, la presenza di standard costruttivi diversi sul territorio, esige una progettazione ad hoc per adattarsi alle esigenze dell'impianto. Il nostro ufficio tecnico è a disposizione per verifiche e progettazione di impianti in grado di adattarsi ad ogni esigenza dove l'unione di apparecchi di illuminazione intelligenti interfacciati a sensori di presenza e luminosità ed una corretta programmazione del sistema, consente di ottenere l'illuminazione migliore con il massimo risparmio energetico. La tecnologie di dimmerazione 1-10V e DALI possono essere utilizzate per interfacciare i segnali attraverso impianti cablati o con tecnologia wireless.

**POSSIBILITÀ DI COLLEGAMENTO BLUETOOTH E WIRELESS RIVOLEGERSI ALL'UFFICIO TECNICO.**

EN

**INTELLIGENT LIGHT CONTROL**

Ideallux® developed a wide range of accessories for every type of installation requirement.

Presence detector, brightness sensor and proper system programming for the best light efficiency and energy saving.

Thanks to the solid experience Ideallux can study and realize the best solution for intelligent and efficient lighting system in order to reduce the energy consumption and at the same time obtain the best lighting efficiency. We satisfy the different requirements of the market through the study of customized project. Our technical department will develop project, where the combination of intelligent lighting fixtures with presence and light sensor and proper system programming allow the best lighting efficiency and energy saving.

**POSSIBILITY OF BLUETOOTH AND WIRELESS LINK REVOLUTION REFER TO THE TECHNICAL OFFICE.**







### Setup via PC software

1. Creation of individual configurations by a graphical user interface
2. Transfer configuration to the remote via USB
3. Beam up configuration to the control unit by a single click

### Application example 2: open plan office with recessed luminaires

**Legend**

- DALI channel 1
- - - DALI channel 2
- - - Sync Connection
- Control unit with cable clamp
- Light- and presence sensor
- Push button coupler

**Functional description**

- Automatic switch ON and start of daylight harvesting when room part is entered
- Automatic switch OFF when whole room is unoccupied
- Unoccupied room part maintains in standby as long as the other part is occupied
- Manual Central ON / OFF via standard push buttons at the entry door

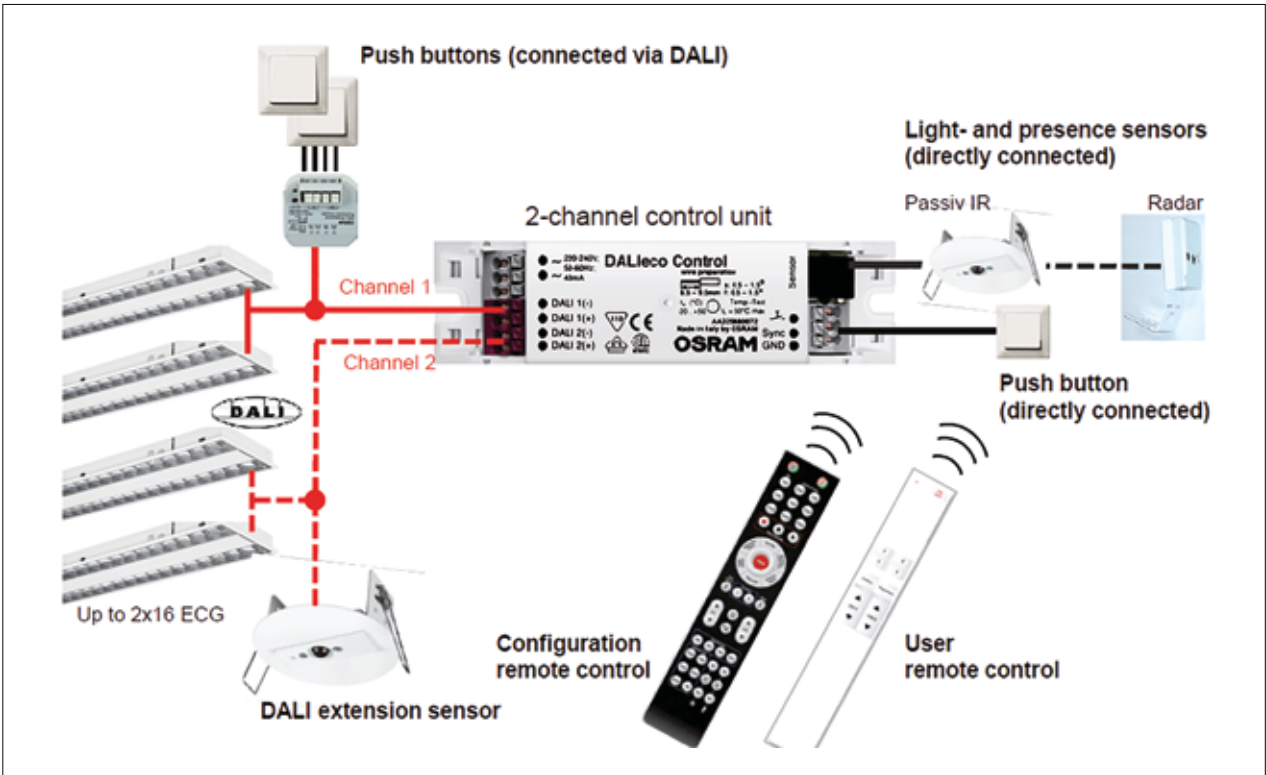



# ZITA



IT

#### **SCHERMO/DIFFUSORE OPALE**

Schermo/diffusore in policarbonato opale. Controllo visivo della sorgente LED. Tipologia di schermo utilizzata nelle situazioni in cui l'estetica dello schermo opale e l'uniformità della luce viene richiesta. Idonea per uffici e zone di transito.

EN

#### **OPAL DIFFUSER**

Opal polycarbonate diffuser. Visual control of LED lighting source. Ideal for applications where opal diffuser aesthetics and light uniformity are requested. Suitable for offices and transit zones.



IT

**INTRO**

La nuova gamma di apparecchi stagni IP67. Apparecchi illuminanti appositamente progettati per l'utilizzo della tecnologia LED per impianti ad elevata efficienza energetica. Corpo unico in policarbonato coestruso. Comfort visivo. Struttura interna in alluminio per un'elevata dissipazione del calore per garantire la massima durata ed efficienza del LED. Nessuna manutenzione.

L'ampia scelta di potenze e flussi rende ZITA utilizzabile negli ambienti industriali e magazzini dove vengono richieste un'elevata efficienza energetica e livelli di sicurezza meccanica elevati. Nel settore alimentare per la sua estrema pulizia e robustezza. Nel settore terziario in situazioni in cui la manutenzione è difficile e negli ambienti ove le temperature sono elevate.

**LIBERTÀ DI SCELTA TECNICA E DI DESIGN DESIDERATO.****Schermo/diffusore in policarbonato.**

Il policarbonato scelto da IDEALLUX è un policarbonato coestruso autoestinguente, resistente ai raggi UV (sistema JEDEX). Policarbonato con ottimo coefficiente di diffusione della luce e di rendimento. Comfort visivo ed efficienza luminosa sono le caratteristiche di tutti gli schermi ZITA. L'esterno liscio del diffusore permette una sua veloce e perfetta pulizia.

EN

**INTRO**

The most wide and complete range of water proof fixtures IP67D. Lighting fixtures designed to use LED technology for high energy-efficient plants. One piece body made of coextruded polycarbonate. Visual comfort. Internal aluminium structure for a higher heat dissipation to guarantee maximum LED service life. No maintenance needed.

Different diffuser types and louver groups enable the application of ZITA in industrial environments and warehouses, where high energetic efficiency and mechanical safety standards are required. In food industry ideal due to its cleanliness and strength. Installation possible at low temperatures too. In service sector where maintenance is difficult and temperatures are high.

**FREEDOM OF TECHNICAL CHOICE AND DESIGN.****Polycarbonate diffuser.**

Coextruded fireproof UV-resistant (JEDEX system) polycarbonate is chosen by IDEALLUX and it has an excellent coefficient of light diffusion and performance. Characteristics of all ZITA diffusers are visual comfort and lighting efficiency. Smooth external part of the diffuser allows its quick and perfect cleaning.



## CARATTERISTICHE COMUNI ALLA SERIE ZITA CHARACTERISTICS COMMON TO THE ZITA SERIES



IT

**Eliminazione dei ganci meccanici per l'assemblaggio scocca-diffusore con la costruzione di un unico corpo/diffusore in policarbonato.** Il policarbonato scelto da IDEALLUX è un policarbonato coestruso autoestinguente, resistente ai raggi UV (sistema JEDEX).

Struttura interna in alluminio per la massima dissipazione del calore. **Parabola in alluminio speculare progettata per la massima efficienza luminosa del LED installato.** ZITA non presenta alcuna BLACK SPOT e l'illuminazione è perfettamente uniforme per tutta la lunghezza.

EN

**One piece polycarbonate body enables the assembling without mechanical hooks.** Polycarbonate selected by IDEALLUX is coextruded fireproof UV-resistant (JEDEX system).

Internal aluminium structure for higher dissipation. **Specular aluminium louver designed for maximum lighting efficiency of the installed LED.** Using ZITA there are NO BLACK SPOTS. Illumination is perfectly uniform.

IT

**ATTENZIONE** è possibile utilizzare i punti di fissaggio preesistenti. Le staffe di fissaggio a innesto rapido scorrono su tutto il dorso della lampada.

EN

**NOTICE** it is possible to use existing fixing points. Quick plug-in fixing brackets slide all over the body of the fixture.

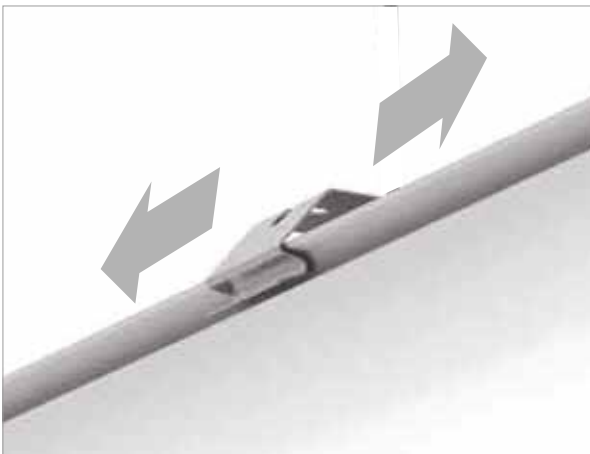





# ZITA

## ZITA. VA VIA COME IL PANE.

MADE IN  
ITALY

GARANZIA  
5 ANNI

LUNGHEZZA  
600-1200-1500

SOSTITUZIONE  
1/2 X 18 - 1/2 X 36 - 1/2 X 58

Vi presentiamo Zita, l'ultima fragrante idea del Gruppo Raina.

Corpo in policarbonato coestruso auto-estinguente opale, ottica diffondente in alluminio anodizzato o speculare, tappi in materiale plastico con guarnizione a tenuta stagna, resistente ai raggi UV.

Fornita completa di pressacavo con morsetto incorporato per collegamento elettrico.

Zita è la soluzione quotidiana per impianti industriali, capannoni, esercizi commerciali, garage, ma anche per condomini, appartamenti e loft.

Con Zita il risparmio è assicurato sia nei consumi che nel prezzo, perché è la lampada più economica e performante nella sua categoria.

Chiedi informazioni al tuo rivenditore di

fiducia e/o visita il sito [www.grupporaina.it](http://www.grupporaina.it).  
Ma fai in fretta, perché sta andando via come il pane.

**GRUPPO RAINA**  
L'unione fa la luce.

# GAMMA PRODOTTI | PRODUCT RANGE

## ZITA (RAPID-3P-5P)

### ZITA (1500-1200-600) OPALE/OPAL

p. 320



Corpo unico in policarbonato coestruso autoestinguente opale, resistente ai raggi UV (sistema anti UV JEDEX). Testata asportabile in policarbonato stampato con guarnizione di tenuta completa di pressacavo per collegamento elettrico. Ottica diffondente in alluminio estruso anodizzato con funzione di dissipatore. Installazione a plafone con staffe di fissaggio a innesto rapido, a sospensione con ganci inox da applicare alle staffe. Sorgente luminosa LED. Emissione diretta. Non idonea per applicazioni esterne. Alimentazione elettronica CAE. A richiesta: dimmerabile DALI (cod. DL) specificare se con funzione PUSH DIM (cod. PD).

*One piece body made of coextruded satin polycarbonate UV-resistant (anti UV system named JEDEX). Removable plastic endcaps with sealed gasket and cable gland for electrical connection. Aluminium wide beam louver with heatsink function. Spring mounting system with quick plug-in fixing brackets, suspension mouting through hooks to be fixed on the brackets. LED light source. Direct light emission. Not suitable for outdoor application. Built in electronic driver CAE. On request: dimmable DALI (code DL) PUSH DIM function (code PD) to be requested*

### ZITA RAPID (1500-1200-600) OPALE/OPAL

p. 322



Corpo unico in policarbonato coestruso autoestinguente opale, resistente ai raggi UV (sistema anti UV JEDEX). Testata in policarbonato stampato con guarnizione di tenuta completa di morsetto 3 poli a pressacavo per collegamento elettrico rapido. Ottica diffondente in alluminio estruso anodizzato con funzione di dissipatore. Installazione a plafone con staffe di fissaggio a innesto rapido, a sospensione con ganci inox da applicare alle staffe. Cablaggio passante 3x1,5 mm<sup>2</sup> versione prolungabile (codice P). Sorgente luminosa LED. Emissione diretta. Non idonea per applicazioni esterne. Alimentazione elettronica CAE.

*One piece body made of coextruded satin polycarbonate UV-resistant (anti UV system named JEDEX). Plastic endcaps with sealed gasket with terminal blocks and cable gland for a quick electrical connection. Aluminium wide beam louver with heatsink function. Spring mounting system with quick plug-in fixing brackets, suspension mouting through hooks to be fixed on the brackets. Extendable version (cod. P) with passing power line 3x1,5mm. LED light source. Direct light emission. Not suitable for outdoor application. Built in electronic driver CAE.*

### ZITA 3P (1500-1200-600) OPALE/OPAL

p. 324



Corpo unico in policarbonato coestruso autoestinguente opale, resistente ai raggi UV (sistema anti UV JEDEX). Testata in policarbonato stampato con guarnizione di tenuta completa di presa e spina 3 poli a innesto rapido per il collegamento elettrico. Ottica diffondente in alluminio estruso anodizzato con funzione di dissipatore. Installazione a plafone con staffe di fissaggio a innesto rapido, a sospensione con ganci inox da applicare alle staffe. Cablaggio passante 3x1,5 mm<sup>2</sup> versione prolungabile (codice P). Sorgente luminosa LED. Emissione diretta. Non idonea per applicazioni esterne. Alimentazione elettronica CAE.

*One piece body made of coextruded satin polycarbonate UV-resistant (anti UV system named JEDEX). Plastic endcaps with sealed gasket with 3 poles connection plug and socket for a quick electrical connection. Aluminium wide beam louver with heatsink function. Spring mounting system with quick plug-in fixing brackets, suspension mouting through hooks to be fixed on the brackets. Extendable version (cod. P) with passing power line 3x1,5mm. LED light source. Direct light emission. Not suitable for outdoor application. Built in electronic driver CAE.*

### ZITA 5P (1500-1200-600) OPALE/OPAL

p. 326



Corpo unico in policarbonato coestruso autoestinguente opale, resistente ai raggi UV (sistema anti UV JEDEX). Testata in policarbonato stampato con guarnizione di tenuta completa di presa e spina 5 poli a innesto rapido per il collegamento elettrico. Ottica diffondente in alluminio estruso anodizzato con funzione di dissipatore. Installazione a plafone con staffe di fissaggio a innesto rapido, a sospensione con ganci inox da applicare alle staffe. Cablaggio passante 5x1 mm<sup>2</sup> versione prolungabile (codice P). Sorgente luminosa LED. Emissione diretta. Non idonea per applicazioni esterne. Alimentazione elettronica CAE. A richiesta: dimmerabile DALI (cod. DL) specificare se con funzione PUSH DIM (cod. PD).

*One piece body made of coextruded satin polycarbonate UV-resistant (anti UV system named JEDEX). Plastic endcaps with sealed gasket with 5 poles connection plug and socket for a quick electrical connection. Aluminium wide beam louver with heatsink function. Spring mounting system with quick plug-in fixing brackets, suspension mouting through hooks to be fixed on the brackets. Extendable version (cod. P) with passing power line 5x1,5mm. LED light source. Direct light emission. Not suitable for outdoor application. Built in electronic driver CAE. On request: dimmable DALI (code DL) PUSH DIM function (code PD) to be requested.*

# FOTOMETRIE | PHOTOMETRIES

## ZITA (RAPID-3P-5P)

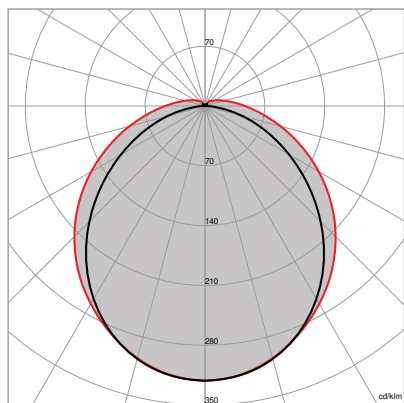

**ZITA**  
OPALE/OPAL



Rimani aggiornato  
*Keep up to date*



# GAMMA PRODOTTI | PRODUCT RANGE

## ZITA LONG (3P-5P)

### ZITA LONG 3P (2400) OPALE/OPAL

p. 328



Corpo unico in policarbonato coestruso autoestinguente opale, resistente ai raggi UV (sistema anti UV JEDEX). Testata in policarbonato stampato con guarnizione di tenuta completa di presa e spina 3 poli a innesto rapido per il collegamento elettrico. Ottica diffondente in alluminio estruso anodizzato con funzione di dissipatore. Installazione a plafone con staffe di fissaggio a innesto rapido, a sospensione con ganci inox da applicare alle staffe. Cablaggio passante 3x1,5mm<sup>2</sup> versione prolungabile (codice P). Sorgente luminosa LED. Emissione diretta. Non idonea per applicazioni esterne. Alimentazione elettronica CAE.

*One piece body made of coextruded satin polycarbonate UV-resistant (anti UV system named JEDEX). Plastic endcaps with sealed gasket with 3 poles connection plug and socket for a quick electrical connection. Aluminium wide beam louver with heatsink function. Spring mounting system with quick plug-in fixing brackets, suspension mouting through hooks to be fixed on the brackets. Extendable version (cod. P) with passing power line 3x1,5mm. LED light source. Direct light emission. Not suitable for outdoor application. Built in electronic driver CAE.*

### ZITA LONG 5P (2400) OPALE/OPAL

p. 330



Corpo unico in policarbonato coestruso autoestinguente opale, resistente ai raggi UV (sistema anti UV JEDEX). Testata in policarbonato stampato con guarnizione di tenuta completa di presa e spina 5 poli a innesto rapido per il collegamento elettrico. Ottica diffondente in alluminio estruso anodizzato con funzione di dissipatore. Installazione a plafone con staffe di fissaggio a innesto rapido, a sospensione con ganci inox da applicare alle staffe. Cablaggio passante 5x1 mm<sup>2</sup> versione prolungabile (codice P). Sorgente luminosa LED. Emissione diretta. Non idonea per applicazioni esterne. Alimentazione elettronica CAE. A richiesta: dimmerabile DALI (cod. DL) specificare se con funzione PUSH DIM (cod. PD).

*One piece body made of coextruded satin polycarbonate UV-resistant (anti UV system named JEDEX). Plastic endcaps with sealed gasket with 5 poles connection plug and socket for a quick electrical connection. Aluminium wide beam louver with heatsink function. Spring mounting system with quick plug-in fixing brackets, suspension mouting through hooks to be fixed on the brackets. Extendable version (cod. P) with passing power line 5x1,5mm. LED light source. Direct light emission. Not suitable for outdoor application. Built in electronic driver CAE. On request: dimmable DALI (code DL) PUSH DIM function (code PD) to be requested.*

# FOTOMETRIE | PHOTOMETRIES

## ZITA LONG (3P-5P)

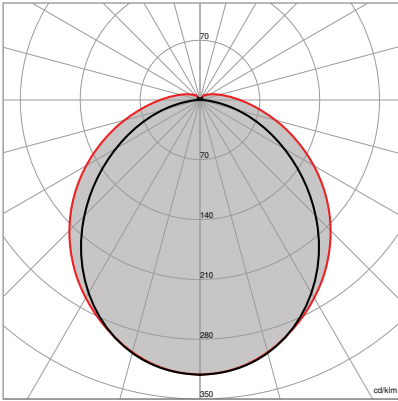

**ZITA LONG**  
OPALE/OPAL



Rimani aggiornato  
*Keep up to date*

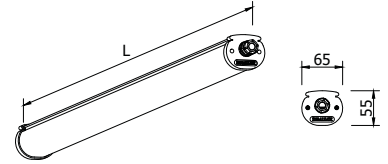

# ZITA OPALE/OPAL

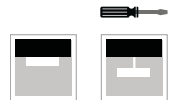

A RICHIESTA | ON REQUEST

<b>5Y WARRANTY</b> 5% FAILURE RATE	<b>60.000 h</b> LED LIFETIME L90B10	<b>100.000 h</b> LED LIFETIME L70B50
---------------------------------------	--	---

>90 CRI	EM EN 60598-2-22	DL DALI	PD PUSH DIM
------------	---------------------	------------	----------------

Relamping	Lumen LED*	Watt LED**	Lumen Out***	Watt	Lumen Watt Out	Configurazione LED LED configuration	Code Code	K	Alimentazione Power Supply	Schermo Diffuser
<b>[L] Lunghezza/Lenght - 1565 mm</b>										
1x58	4000	24	2945	26	> 113	_____	IZT3	W: 3.000 N: 4.000 C: 6.000	— : CAE  A RICHIESTA   ON REQUEST DL: DALI PD: PUSH DIM	opale opal
2x58	8400	48	6190	52	> 119	_____	IZT6			
<b>[L] Lunghezza/Lenght - 1190 mm</b>										
1x36	3000	18	2210	19,5	> 113	_____	IZT2	W: 3.000 N: 4.000 C: 6.000	— : CAE  A RICHIESTA   ON REQUEST DL: DALI PD: PUSH DIM	opale opal
2x36	6000	37	4640	40	> 116	_____	IZT5			
<b>UT</b> 2x36	6400	38	4800	41	> 117	_____	IZUT2			
<b>UT</b> 2x58	8550	47	6190	52	> 119	_____	IZUT5			
<b>[L] Lunghezza/Lenght - 625 mm</b>										
1x18	1350	7,5	995	9	> 108	_____	IZT1	W: 3.000 N: 4.000 C: 6.000	— : CAE  A RICHIESTA   ON REQUEST DL: DALI PD: PUSH DIM	opale opal
2x18	2780	17	2050	18,5	> 111	_____	IZT4			

CE	⊕	>80 CRI	IP67 EN 60529	230 V 2014/35/UE	50/60 Hz	IK 09 EN 60068	850° EN 60695	A++ A+ A	RG 0 EN 62471	🏠
----	---	------------	------------------	---------------------	-------------	-------------------	------------------	----------------	------------------	---

**ZITA 1500-1200-600**  
Testata asportabile per connessione elettrica.  
Removable endcap for electrical connection.

Temperatura ambiente min e max | Min and max room temperature:  
**(-20° +40°)**

\* Lumen nominali LED max a 25° | Nominal lumen at max 25°

\*\* Potenza dei LED | LED power

\*\*\* Flusso totale in uscita dall'apparecchio a temperatura di lavoro (Ta 25° - 4.000 K).  
Total lighting fitting flux output at working temperature (Ta 25° - 4.000 K).  
(3.000 K -8% - CRI 90 -10%).



Fotometrie | Photometries  
p. 317



Schema di cablaggio | Connection scheme  
p. XXVIII-XXIX



Descrizione prodotto | Product description  
p. 316



Accessori | Accessories  
p. 332



**ZITA** con pressacavo (codice IZT..) | *with cablegand (code IZT..)*

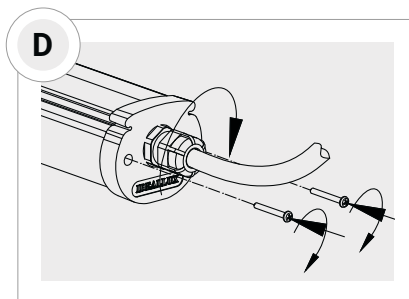
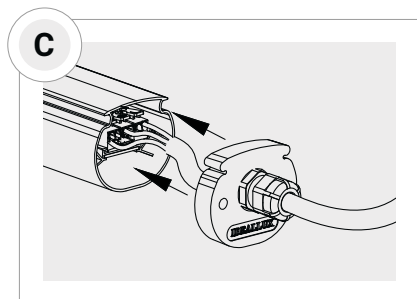
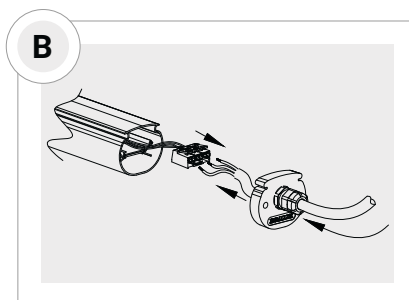
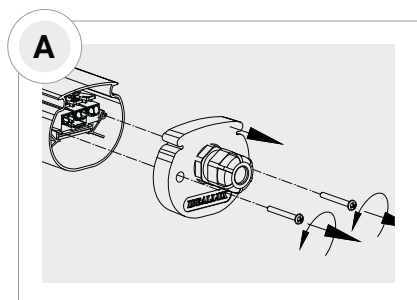

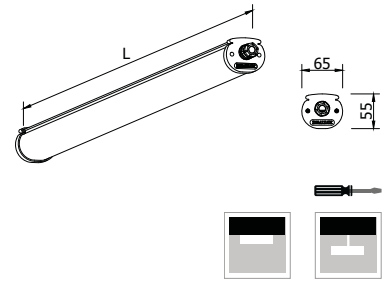

# ZITA RAPID OPALE/OPAL

<b>5Y WARRANTY</b> 5% FAILURE RATE	<b>60.000 h</b> LED LIFETIME L90B10	<b>100.000 h</b> LED LIFETIME L70B50
---------------------------------------	--	---

A RICHIESTA | ON REQUEST

>90  
CRI

NON DISPONIBILE | NOT AVAILABLE



Relamping	Lumen LED*	Watt LED**	Lumen Out***	Watt	Lumen Watt Out	Configurazione LED LED configuration	Codice Code	Cod. Prolungabile Extension Code	K	Alimentazione Power Supply	Schermo Diffuser
<b>[L] Lunghezza/Lenght - 1565 mm   Prolungabile/Extendable - 1600 mm</b>											
1x58	<b>4000</b>	24	2945	26	> 113	_____	<b>IZTR3</b>	<b>IZTRP3</b>	<b>W:</b> 3.000 <b>N:</b> 4.000 <b>C:</b> 6.000	— : CAE	<b>opale</b> <i>opal</i>
2x58	<b>8400</b>	48	6190	52	> 119	_____	<b>IZTR6</b>	<b>IZTRP6</b>			
<b>[L] Lunghezza/Lenght - 1190 mm   Prolungabile/Extendable - 1225 mm</b>											
1x36	<b>3000</b>	18	2210	19,5	> 113	_____	<b>IZTR2</b>	<b>IZTRP2</b>	<b>W:</b> 3.000 <b>N:</b> 4.000 <b>C:</b> 6.000	— : CAE	<b>opale</b> <i>opal</i>
2x36	<b>6000</b>	37	4640	40	> 116	_____	<b>IZTR5</b>	<b>IZTRP5</b>			
<b>UT</b> 2x30	<b>6400</b>	38	4800	41	> 117	_____	<b>IZUTR2</b>	<b>IZUTRP2</b>			
<b>UT</b> 2x58	<b>8550</b>	47	6190	52	> 119	_____	<b>IZUTR5</b>	<b>IZUTRP5</b>			
<b>[L] Lunghezza/Lenght - 625 mm   Prolungabile/Extendable - 660 mm</b>											
1x18	<b>1350</b>	7,5	995	9	> 108	_____	<b>IZTR1</b>	<b>IZTRP1</b>	<b>W:</b> 3.000 <b>N:</b> 4.000 <b>C:</b> 6.000	— : CAE	<b>opale</b> <i>opal</i>
2x18	<b>2780</b>	17	2050	18,5	> 111	_____	<b>IZTR4</b>	<b>IZTRP4</b>			

		>80 CRI	IP67 EN 60529	230 V 2014/35/UE	50/60 Hz	IK 09 EN 60068	850° EN 60695	A++ A+ A	RG 0 EN 62471	
--	--	------------	------------------	---------------------	-------------	-------------------	------------------	----------------	------------------	--

**ZITA RAPID 1500-1200-600**  
Testata fissa completa di morsetto 3 poli a pressacavo per collegamento elettrico rapido.  
Endcaps with terminal blocks and cable gland for for a quick electrical connection.

Temperatura ambiente min e max | Min and max room temperature:  
**(-20° +40°)**

\* Lumen nominali LED max a 25° | Nominal lumen at max 25°  
\*\* Potenza dei LED | LED power  
\*\*\* Flusso totale in uscita dall'apparecchio a temperatura di lavoro (Ta 25° - 4.000 K).  
Total lighting fitting flux output at working temperature (Ta 25° - 4.000 K).  
(3.000 K -8% - CRI 90 -10%).

Fotometrie   Photometries p. 317	Schema di cablaggio   Connection scheme p. XXVIII-XXIX	Descrizione prodotto   Product description p. 316	Accessori   Accessories p. 332
-------------------------------------	---	--	-----------------------------------

**ZITA RAPID** con morsetto 3 poli a pressacavo (codice IZTR..) per collegamento elettrico rapido, non necessita l'apertura dell'apparecchio, emergenza non fornibile” | *With terminal blocks and cable gland for a quick electrical connection, does not need opening the luminaire, emergency version not available. (code IZTR..)*

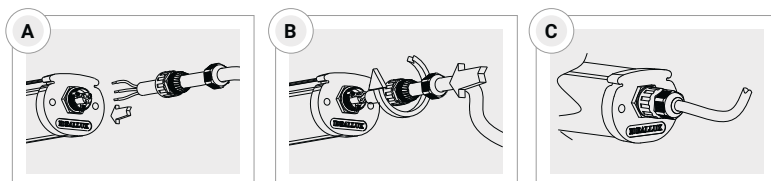

**ZITA RAPID P** cablaggio passante 3 poli (codice IZTRP..), completa di morsettiera stagna, non necessita l'apertura dell'apparecchio, **emergenza non fornibile** | *Passing power line 3 poles (code IZTRP..) with terminal blocks and cable gland for for a quick electrical connection, does not need opening the luminaire, emergency version not available.*

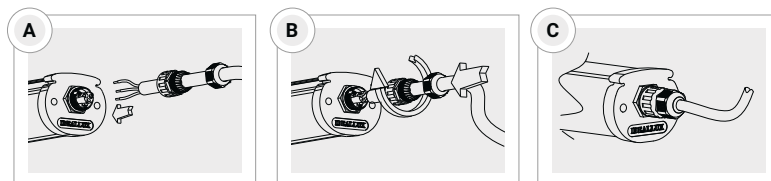
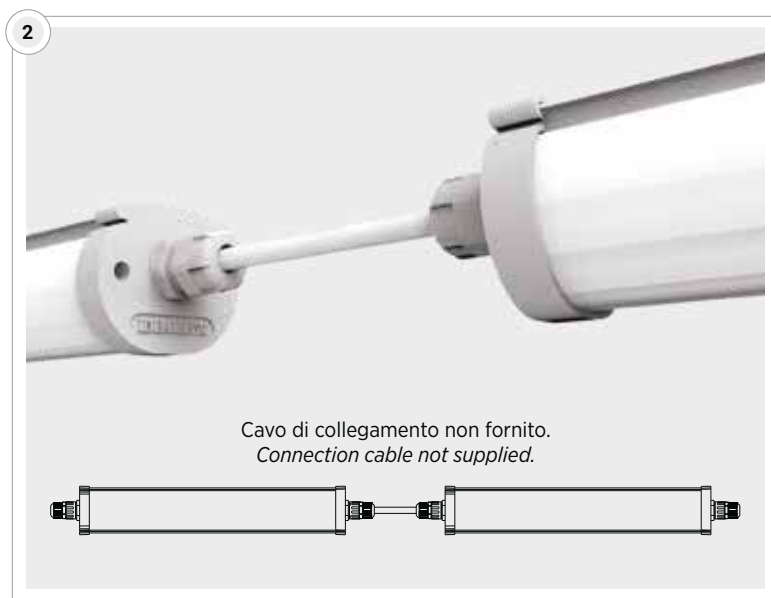

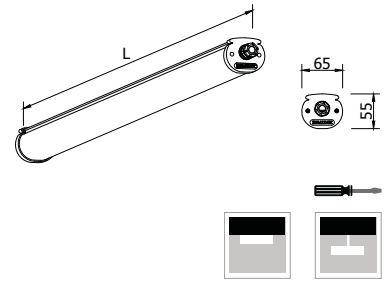

A RICHIESTA | ON REQUEST

>90  
CRI

NON DISPONIBILE | NOT AVAILABLE



# ZITA 3P OPALE/OPAL

<b>5Y WARRANTY</b> 5% FAILURE RATE	<b>60.000 h</b> LED LIFETIME L90B10	<b>100.000 h</b> LED LIFETIME L70B50
---------------------------------------	--	---

Relamping	Lumen LED*	Watt LED**	Lumen Out***	Watt	Lumen Watt Out	Configurazione LED LED configuration	Code Code	Cod. Prolungabile Extension Code	K*	Alimentazione Power Supply	Schermo Diffuser
<b>[L] Lunghezza/Lenght - 1565 mm   Prolungabile/Extendable - 1585 mm</b>											
1x58	4000	24	2945	26	> 113	_____	IZT3(..*)3P	IZTP3(..*)3P	W: 3.000 N: 4.000 C: 6.000	— : CAE	opale opal
2x58	8400	48	6190	52	> 119	_____	IZT6(..*)3P	IZTP6(..*)3P			
<b>[L] Lunghezza/Lenght - 1190 mm   Prolungabile/Extendable - 1210 mm</b>											
1x36	3000	18	2210	19,5	> 113	_____	IZT2(..*)3P	IZTP2(..*)3P	W: 3.000 N: 4.000 C: 6.000	— : CAE	opale opal
2x36	6000	37	4640	40	> 116	_____	IZT5(..*)3P	IZTP5(..*)3P			
<b>UT</b> 2x30	6400	38	4800	41	> 117	_____	IZUT2(..*)3P	IZUTP2(..*)3P			
<b>UT</b> 2x58	8550	47	6190	52	> 119	_____	IZUT5(..*)3P	IZUTP5(..*)3P			
<b>[L] Lunghezza/Lenght - 625 mm   Prolungabile/Extendable - 645 mm</b>											
1x18	1350	7,5	995	9	> 108	_____	IZT1(..*)3P	IZTP1(..*)3P	W: 3.000 N: 4.000 C: 6.000	— : CAE	opale opal
2x18	2780	17	2050	18,5	> 111	_____	IZT4(..*)3P	IZTP4(..*)3P			

CE	⊕	>80 CRI	IP67 EN 60529	230 V 2014/35/UE	50/60 Hz	IK 09 EN 60068	850° EN 60695	A++ A+ A	RG 0 EN 62471	🏠
----	---	------------	------------------	---------------------	-------------	-------------------	------------------	----------------	------------------	---

**ZITA 3P 1500-1200-600**  
 Testata fissa completa di presa e spina 3 poli ad innesto rapido per il collegamento elettrico rapido.  
 Fixed endcap with 3 poles connection plug and socket for a quick electrical connection.

Temperatura ambiente min e max | Min and max room temperature:  
**(-20° +40°)**

\* Lumen nominali LED max a 25° | Nominal lumen at max 25°

\*\* Potenza dei LED | LED power

\*\*\* Flusso totale in uscita dall'apparecchio a temperatura di lavoro (Ta 25° - 4.000 K).  
 Total lighting fitting flux output at working temperature (Ta 25° - 4.000 K).  
 (3.000 K -8% - CRI 90 -10%).

Fotometrie   Photometries p. 317	Schema di cablaggio   Connection scheme p. XXVIII-XXIX	Descrizione prodotto   Product description p. 316	Accessori   Accessories p. 332
-------------------------------------	---	--	-----------------------------------

**ZITA 3P** (codice IZT..3P) completa di presa e spina 3 poli a innesto rapido per il collegamento elettrico". | *3 poles connection plug and socket for a quick electrical connection included (code IZT..3P)*

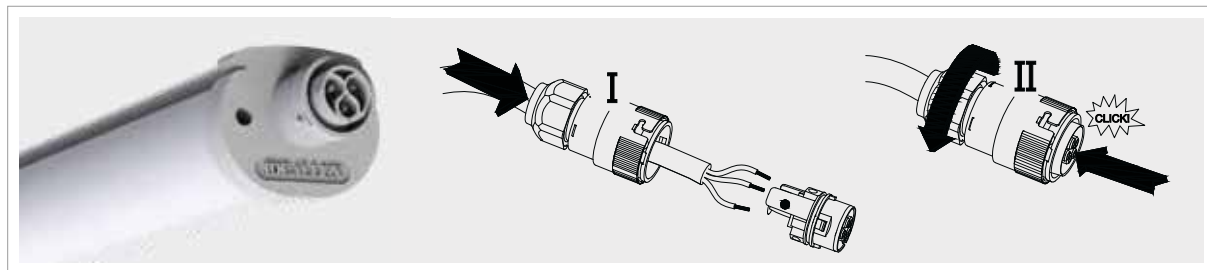

**ZITA 3P PROLUNGABILE** (codice IZTP..3P) cablaggio passante 3 poli, completa di presa maschio e femmina per fila continua. | *With passing power line 3 poles, plug and socket for continuous line included (code IZTP..3P)*



**PRESA FEMMINA**  
Per alimentazione da cablare  
Da ordinare (codice 7PR3702-V)  
Lunghezza 54mm.

**FEMALE SOCKET**  
Female socket to be wired  
To be ordered separately (code 7PR3702-V)  
Length 54 mm.

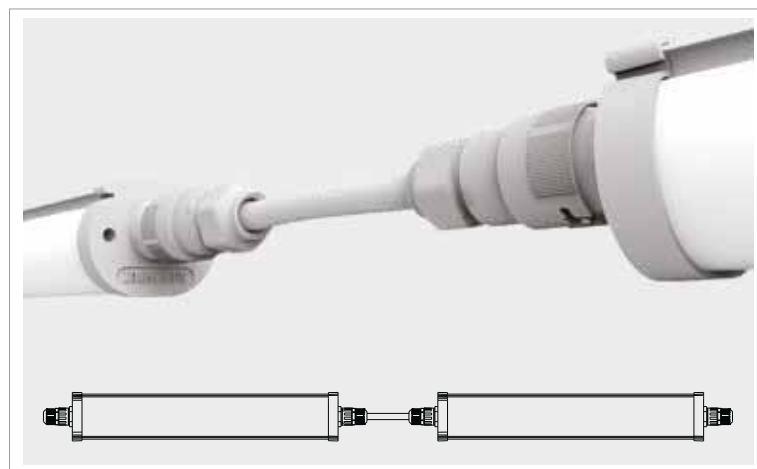
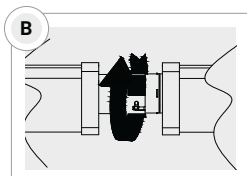
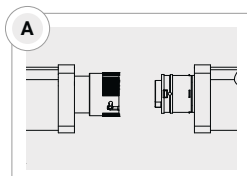

Prolunga lunghezza 300-600-800-1000 mm 3 POLI, completa di presa femmina e spina maschio. Vedi pagina 332.  
*Extension cord 300-600-800-1000mm with 3 POLES, plug and socket. See page 332.*

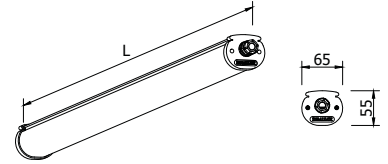

# ZITA 5P OPALE/OPAL



A RICHIESTA | ON REQUEST

<b>5Y WARRANTY</b> 5% FAILURE RATE	<b>60.000 h</b> LED LIFETIME L90B10	<b>100.000 h</b> LED LIFETIME L70B50
---------------------------------------	--	---

>90 CRI	EM EN 60969-2-22	DL DALI	PD PUSH DIM
------------	---------------------	------------	----------------

Relamping	Lumen LED*	Watt LED**	Lumen Out***	Watt	Lumen Watt Out	Configurazione LED LED configuration	Code Code	Cod. Prolungabile Extension Code	K*	Alimentazione Power Supply	Schermo Diffuser
<b>[L] Lunghezza/Lenght - 1565 mm   Prolungabile/Extendable - 1585 mm</b>											
1x58	4000	24	2945	26	> 113	_____	IZT3(..*)5P	IZTP3(..*)5P	W: 3.000	— : CAE	opale opal
2x58	8400	48	6190	52	> 119	_____	IZT6(..*)5P	IZTP6(..*)5P	N: 4.000 C: 6.000	A RICHIESTA   ON REQUEST DL: DALI PD: PUSH DIM	
<b>[L] Lunghezza/Lenght - 1190 mm   Prolungabile/Extendable - 1210 mm</b>											
1x36	3000	18	2210	19,5	> 113	_____	IZT2(..*)5P	IZTP2(..*)5P	W: 3.000	— : CAE	opale opal
2x36	6000	37	4640	40	> 116	_____	IZT5(..*)5P	IZTP5(..*)5P	N: 4.000 C: 6.000	A RICHIESTA   ON REQUEST DL: DALI PD: PUSH DIM	
<b>UT</b> 2x30	6400	38	4800	41	> 117	_____	IZUT2(..*)5P	IZUTP2(..*)5P			
<b>UT</b> 2x58	8550	47	6190	52	> 119	_____	IZUT5(..*)5P	IZUTP5(..*)5P			
<b>[L] Lunghezza/Lenght - 625 mm   Prolungabile/Extendable - 645 mm</b>											
1x18	1350	7,5	995	9	> 108	_____	IZT1(..*)5P	IZTP1(..*)5P	W: 3.000	— : CAE	opale opal
2x18	2780	17	2050	18,5	> 111	_____	IZT4(..*)5P	IZTP4(..*)5P	N: 4.000 C: 6.000	A RICHIESTA   ON REQUEST DL: DALI PD: PUSH DIM	

CE	⊕	>80 CRI	IP67 EN 60529	230 V 2014/35/UE	50/60 Hz	IK 09 EN 60068	850° EN 60695	A++ A+ A	RG 0 EN 62471	🏠
----	---	------------	------------------	---------------------	-------------	-------------------	------------------	----------------	------------------	---

### ZITA 5P 1500-1200-600

Testata fissa completa di presa e spina 5 poli ad innesto rapido per il collegamento elettrico rapido.  
Fixed endcap with 5 poles connection plug and socket for a quick electrical connection.

Temperatura ambiente min e max | Min and max room temperature:  
**(-20° +40°)**

\* Lumen nominali LED max a 25° | Nominal lumen at max 25°

\*\* Potenza dei LED | LED power

\*\*\* Flusso totale in uscita dall'apparecchio a temperatura di lavoro (Ta 25° - 4.000 K).  
Total lighting fitting flux output at working temperature (Ta 25° - 4.000 K).  
(3.000 K -8% - CRI 90 -10%).



Fotometrie | Photometries  
p. 317



Schema di cablaggio | Connection scheme  
p. XXVIII-XXIX



Descrizione prodotto | Product description  
p. 316



Accessori | Accessories  
p. 332



**ZITA 5P** (codice IZT..5P) completa di presa e spina 5 poli a innesto rapido per il collegamento elettrico” | *5 poles connection plug and socket for a quick electrical connection included. (code IZT..5P).*

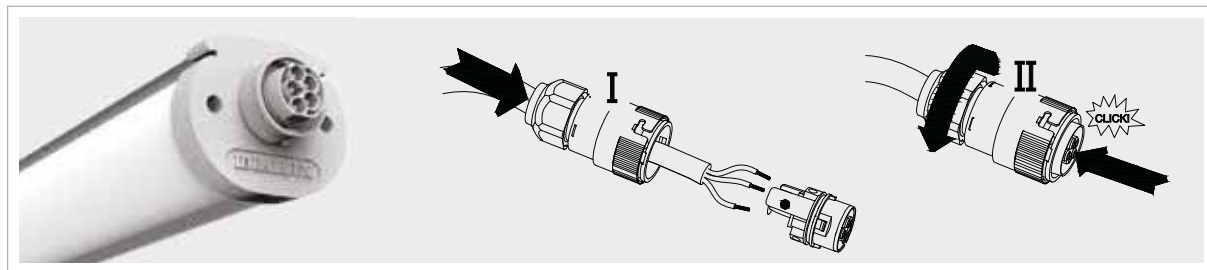

**ZITA 5P PROLUNGABILE** (codice IZTP..5P) cablaggio passante 5 poli, completa di presa maschio e femmina per fila continua. | *with passing power line 5 poles, plug and socket for continuous line included. (codice IZTP..5P)*

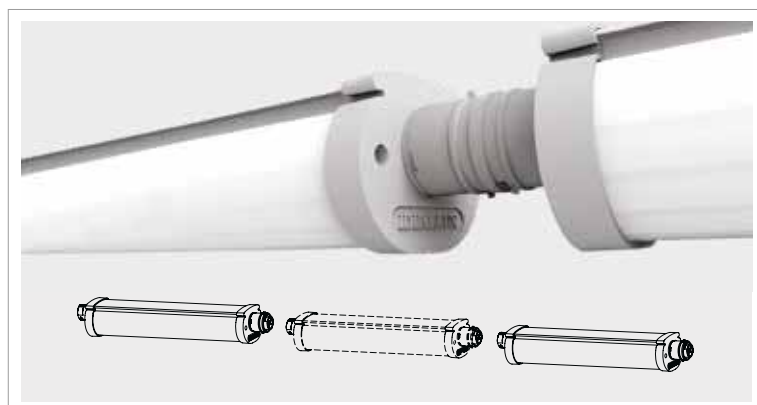

**PRESA FEMMINA**  
Per alimentazione da cablare  
Da ordinare (codice 7PR5702-V)  
Lunghezza 54mm.

**FEMALE SOCKET**  
Female socket to be wired  
To be ordered separately (code 7PR5702-V)  
Length 54 mm.

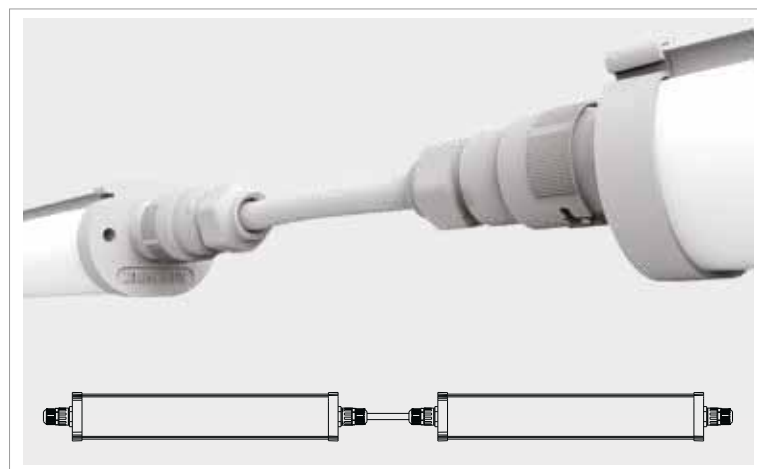
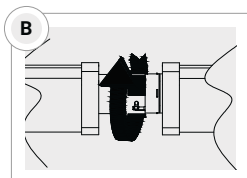
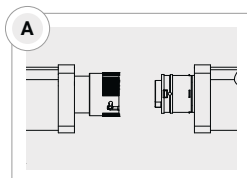

Prolunga lunghezza 300-600-800-1000 mm 5 POLI, completa di presa femmina e spina maschio. Vedi pagina 332.  
*Extension cord 300-600-800-1000mm with 5 POLES, plug and socket. See page 332.*

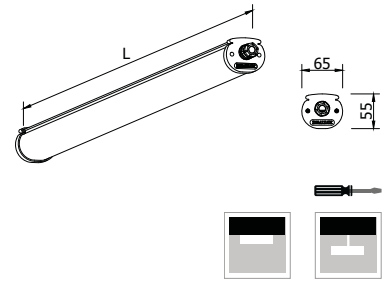

A RICHIESTA | ON REQUEST

>90  
CRI

NON DISPONIBILE | NOT AVAILABLE



# ZITA LONG 3P OPALE/OPAL

<b>5Y WARRANTY</b> 5% FAILURE RATE	<b>60.000 h</b> LED LIFETIME L90B10	<b>100.000 h</b> LED LIFETIME L70B50
---------------------------------------	--	---

Relamping	Lumen LED*	Watt LED**	Lumen Out***	Watt	Lumen Watt Out	Configurazione LED LED configuration	Code Code	Cod. Prolungabile Extension Code	K*	Alimentazione Power Supply	Schermo Diffuser
<b>[L] Lunghezza/Lenght - 2315 mm   Prolungabile/Extendable - 2335 mm</b>											
2x36	<b>6000</b>	36	4420	39	> 113	_____	<b>IZG11(..*)3P</b>	<b>IZGP11(..*)3P</b>	W: 3.000 N: 4.000 C: 6.000	- : CAE	<b>opale</b> <i>opal</i>
2x36	<b>12000</b>	76	9240	80	> 116	_____	<b>IZG15(..*)3P</b>	<b>IZGP15(..*)3P</b>			
<b>UT</b> 2+2x58	<b>16800</b>	94	12380	104	> 119	_____	<b>IZG16(..*)3P</b>	<b>IZGP16(..*)3P</b>			

		>80 CRI	IP67 EN 60529	230 V 2014/35/UE	50/60 Hz	IK 09 EN 60068	850° EN 60695		RG 0 EN 62471	
--	--	------------	------------------	---------------------	-------------	-------------------	------------------	--	------------------	--

**ZITA LONG 3P 1500-1200-600**  
 Testata fissa completa di presa e spina 3 poli ad innesto rapido per il collegamento elettrico rapido.  
 Fixed endcap with 3 poles connection plug and socket for a quick electrical connection

Temperatura ambiente min e max | *Min and max room temperature:*  
**(-20° +40°)**

\* Lumen nominali LED max a 25° | *Nominal lumen at max 25°*

\*\* Potenza dei LED | *LED power*

\*\*\* Flusso totale in uscita dall'apparecchio a temperatura di lavoro (Ta 25° - 4.000 K).  
 Total lighting fitting flux output at working temperature (Ta 25° - 4.000 K).  
 (3.000 K -8% - CRI 90 -10%).



**ZITA LONG 3P** (codice IZT..3P) completa di presa e spina 3 poli a innesto rapido per il collegamento elettrico".  
*3 poles connection plug and socket for a quick electrical connection included. (code IZT..3P)*

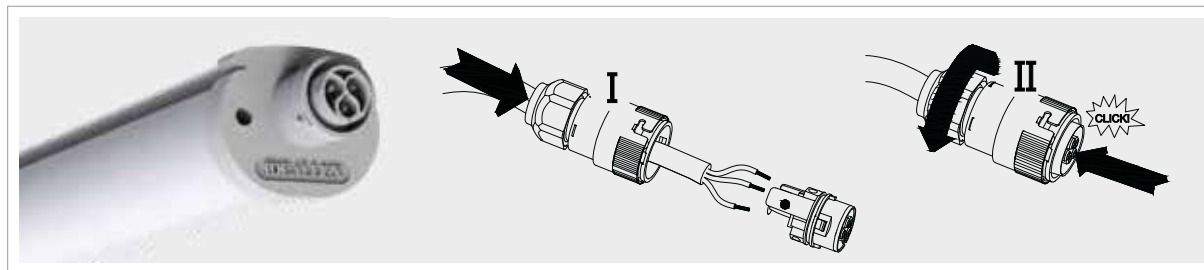

**ZITA LONG 3P PROLUNGABILE** (codice IZTP..3P) cablaggio passante 3 poli, completa di presa maschio e femmina per fila continua. | *With passing power line 3 poles, plug and socket for continuous line included (code IZTP..3P)*

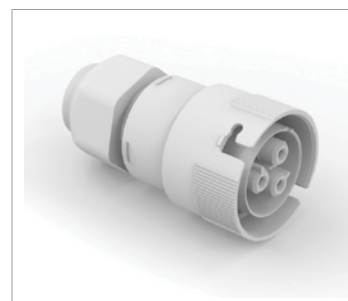

**PRESA FEMMINA**  
 Per alimentazione da cablare  
 Da ordinare (codice 7PR3702-V)  
 Lunghezza 54mm.

**FEMALE SOCKET**  
 Female socket to be wired  
 To be ordered separately (code 7PR3702-V)  
 Length 54 mm.

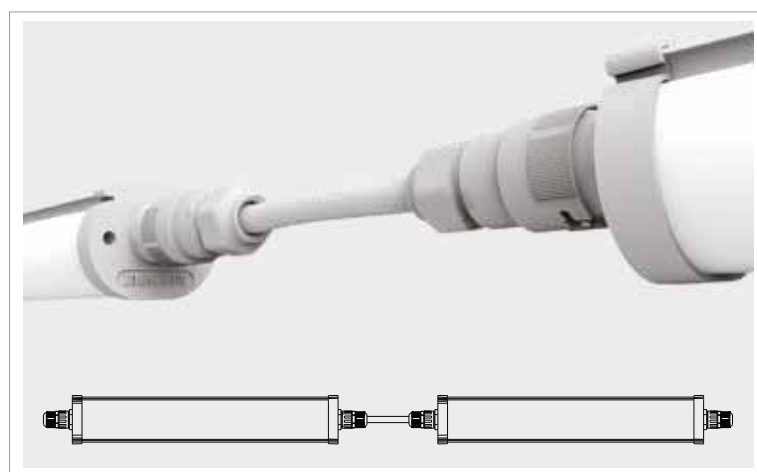
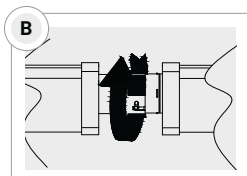
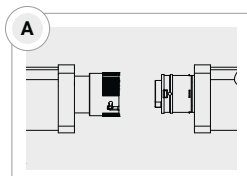

Prolunga lunghezza 300-600-800-1000 mm 3 POLI, completa di presa femmina e spina maschio. Vedi pagina 332.  
*Extension cord 300-600-800-1000mm with 3 POLES, plug and socket. See page 332.*

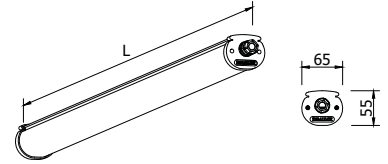

# ZITA LONG 5P

## OPALE/OPAL



A RICHIESTA | ON REQUEST

<b>5Y WARRANTY</b> 5% FAILURE RATE	<b>60.000 h</b> LED LIFETIME L90B10	<b>100.000 h</b> LED LIFETIME L70B50
---------------------------------------	--	---

<b>&gt;90</b> CRI	<b>EM</b> EN 60598-2-22	<b>DL</b> DALI	<b>PD</b> PUSH DIM
----------------------	----------------------------	-------------------	-----------------------

Relamping	Lumen LED*	Watt LED**	Lumen Out***	Watt	Lumen Watt Out	Configurazione LED LED configuration	Code Code	Cod. Prolungabile Extension Code	K*	Alimentazione Power Supply	Schermo Diffuser
<b>[L] Lunghezza/Lenght - 2315 mm   Prolungabile/Extendable - 2335 mm</b>											
2x36	<b>6000</b>	36	4420	39	> 113	_____	<b>IZG1(..*)5P</b>	<b>IZGP1(..*)5P</b>	<b>W:</b> 3.000 <b>N:</b> 4.000 <b>C:</b> 6.000	— : CAE elettronica electronic  <b>DL:</b> DALI (funzione <b>PD****</b> a richiesta/On request)	<b>opale</b> <i>opal</i>
2x36	<b>12000</b>	76	9240	80	> 116	_____	<b>IZG5(..*)5P</b>	<b>IZGP5(..*)5P</b>			
<b>UT</b> 2+2x58	<b>16800</b>	94	12380	104	> 119	_____	<b>IZG6(..*)5P</b>	<b>IZGP6(..*)5P</b>			

<b>CE</b>		<b>&gt;80</b> CRI	<b>IP67</b> EN 60529	<b>230 V</b> 2014/35/UE	<b>50/60</b> Hz	<b>IK 09</b> EN 60068	<b>850°</b> EN 60695	<b>A++</b> <b>A+</b> <b>A</b>	<b>RG 0</b> EN 62471	
-----------	--	----------------------	-------------------------	----------------------------	--------------------	--------------------------	-------------------------	-------------------------------------	-------------------------	--

### ZITA LONG 5P 1500-1200-600

Testata fissa completa di presa e spina 5 poli ad innesto rapido per il collegamento elettrico rapido.  
Fixed endcap with 5 poles connection plug and socket for a quick electrical connection

Temperatura ambiente min e max | Min and max room temperature:  
**(-20° +40°)**

\* Lumen nominali LED max a 25° | Nominal lumen at max 25°

\*\* Potenza dei LED | LED power

\*\*\* Flusso totale in uscita dall'apparecchio a temperatura di lavoro (Ta 25° - 4.000 K).  
Total lighting fitting flux output at working temperature (Ta 25° - 4.000 K).  
(3.000 K -8% - CRI 90 -10%).



Fotometrie | Photometries  
p. 319



Schema di cablaggio | Connection scheme  
p. XXVIII-XXIX



Descrizione prodotto | Product description  
p. 318



Accessori | Accessories  
p. 332

**ZITA LONG 5P** (codice IZT..5P) completa di presa e spina 5 poli a innesto rapido per il collegamento elettrico.  
*5 poles connection plug and socket for a quick electrical connection included. (code IZT..5P)*

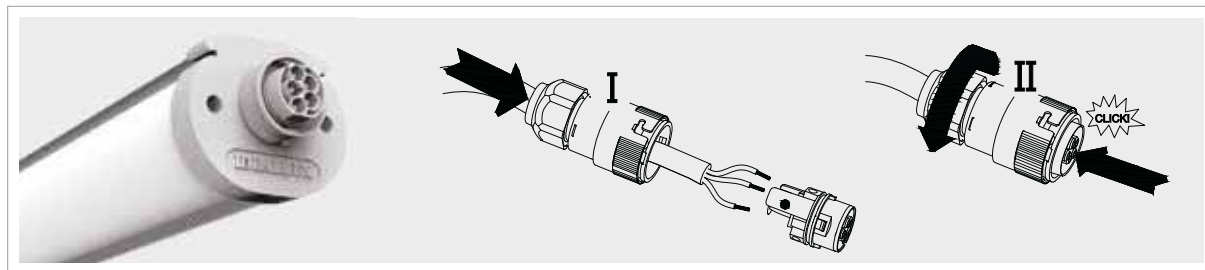

**ZITA LONG 5P PROLUNGABILE** (codice IZTP..5P) cablaggio passante 5 poli, completa di presa maschio e femmina per fila continua. | *With passing power line 5 poles, plug and socket for continuous line included (code IZTP..5P)*

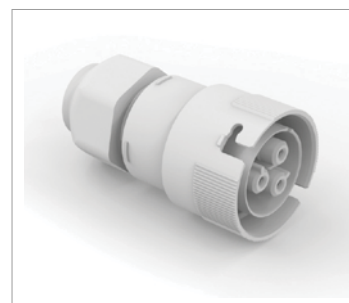
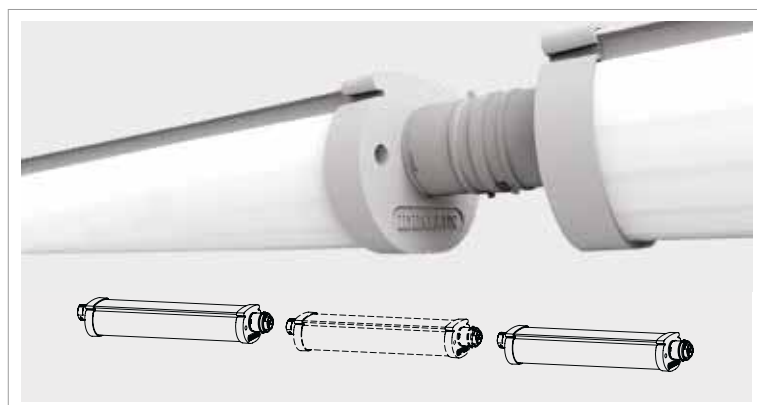





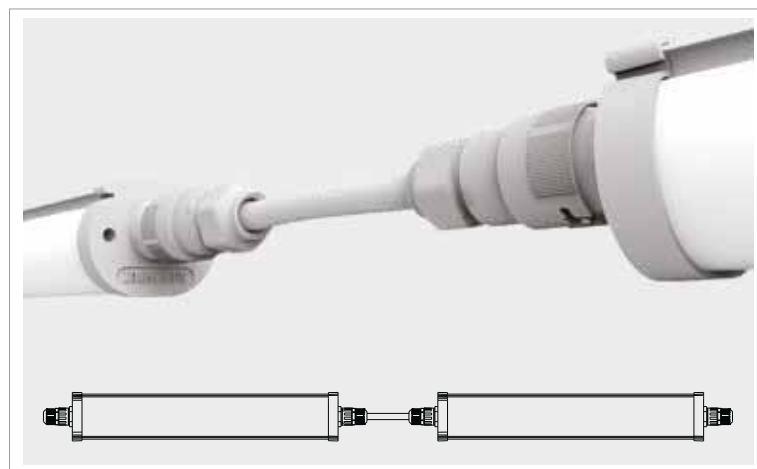
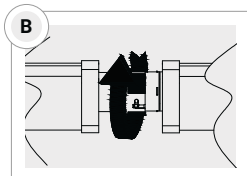
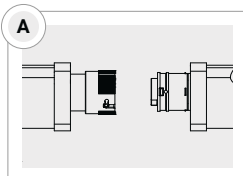

**PRESA FEMMINA**  
 Per alimentazione da cablare  
 Da ordinare (codice 7PR5702-V)  
 Lunghezza 54mm.

**FEMALE SOCKET**  
 Female socket to be wired  
 To be ordered separately (code 7PR5702-V)  
 Length 54 mm.



Prolunga lunghezza 300-600-800-1000 mm 5 POLI, completa di presa femmina e spina maschio. Vedi pagina 332.  
*Extension cord 300-600-800-1000mm with 5 POLES, plug and socket. See page 332.*

	DESCRIZIONE ACCESSORIO   ACCESSORY DESCRIPTION	CODICE   CODE
	<b>STAFFE DI FISSAGGIO ANTIVANDOLO</b> <b>FIXING SPRINGS VANDAL PROOF</b>	<b>IN-MOL-AV</b>
	<b>ATTACCO CLEAN</b> Per uso alimentare <b>CLEAN CONNECTION</b> For feed use	<b>IN600</b> <b>IN1200</b> <b>IN1500</b> <b>IN2400</b>
	<b>PROLUNGA LUNGHEZZA</b> 300/600/800/1000 mm <b>EXTENSION FOR LINE APPLICATIONS</b> 300/600/800/1000 mm	<b>INHP/P/300</b> <b>INHP/P/600</b> <b>INHP/P/800</b> <b>INHP/P/1000</b>
	<b>PROLUNGA LUNGHEZZA</b> 300/600/800/1000 mm <b>EXTENSION FOR LINE APPLICATIONS</b> 300/600/800/1000 mm	<b>INHP5/P/300</b> <b>INHP5/P/600</b> <b>INHP5/P/800</b> <b>INHP5/P/1000</b>
	<b>PRESA FEMMINA</b> Per alimentazione da cablare (da ordinare per INNOVA/P). Lunghezza 54mm. <b>FEMALE SOCKET</b> Female socket to be wired (to be ordered for INNOVA/P) Length 54 mm.	<b>7PR3702-V</b> (3 poli) <b>7PR5702-V</b> (5 poli)
	<b>SPINA MASCHIO</b> Per alimentazione da cablare <b>MALE PLUG</b> Male plug to be wired	<b>7PR3701</b> (3 poli) <b>7PR5701</b> (5 poli)
	<b>TERMINALE</b> Chiusura file <b>END CAP</b>	<b>IN-KIT-TAP</b>
	<b>INNESTO TUBO</b> Ø 20mm <b>JOINT FOR RIGIDE CONDUIT</b> Ø 20mm	<b>7PR3700-C</b>



**MARKETING ZITA**  
 ESPOSITORE IN CARTONE PORTA ZITA | *CARTON BOX HOLDER ZITA*



Codice d'ordine | *Order code:* **ESP1ZITA**



GRUPPO  RAINA

L'unione fa la luce.

IDEALLUX®

*Lookup*

COLOMBO



Download PDF

[www.grupporaina.it/it/download/cataloghi](http://www.grupporaina.it/it/download/cataloghi)

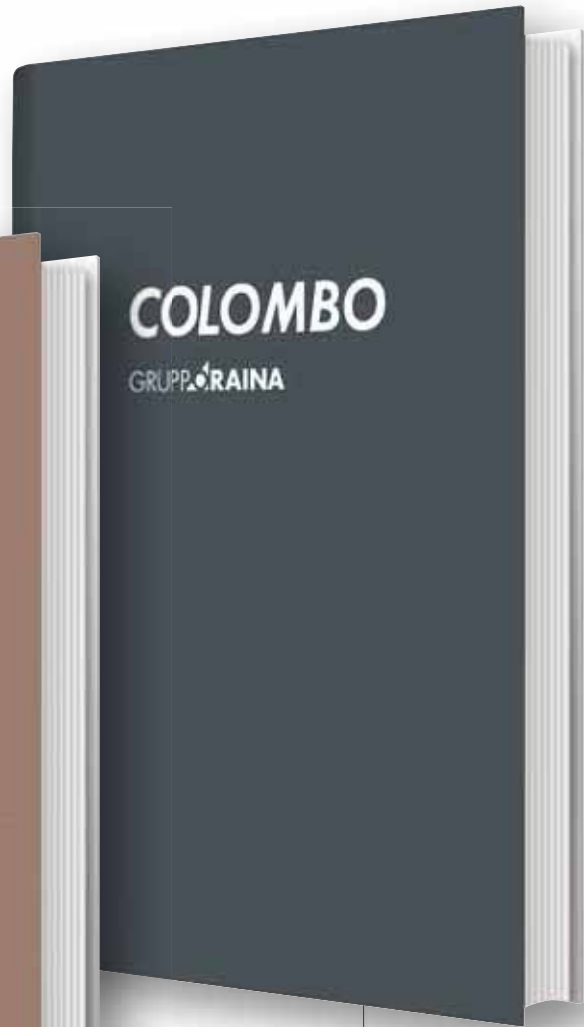
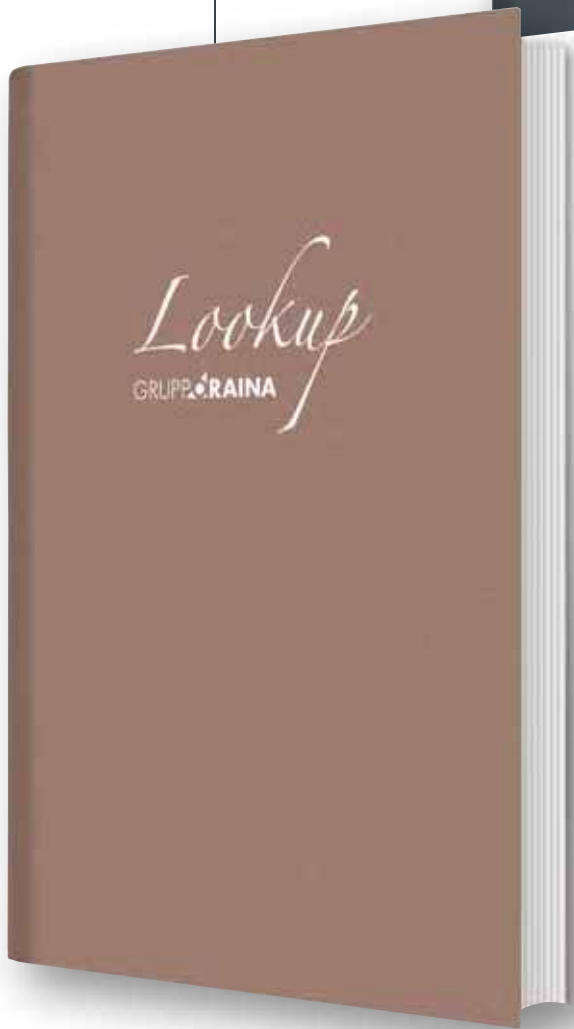

Download PDF

[www.grupporaina.it/it/download/cataloghi](http://www.grupporaina.it/it/download/cataloghi)

IT

**COLOMBO** marchio specifico per gli apparecchi stradali, arredo urbano e da esterno.  
**LOOKUP®** con la sua nuova e ampia gamma di apparecchi decorativi e architettonici.

EN

**COLOMBO** brand specific for street and outdoor fixtures.  
**LOOKUP®** with its wide and new range of decorative lighting fittings.

PRODOTTI | PRODUCTS

SUSPENSION



Aquadro i-L



Eliot i-L



Nori i-L



Jeè i-L



Squak



Loft



Maciste



Round



Round IP55



Arrondo



Ufo



Tubi CM-S



Adalpina



Circo



Olimpia



Libra



Opalia i-L



Bolerino

WALL



Alba



Tink



Faces M



Calea



Zoe M - Zoe



Talè M - Talè



Ester



Dudu



Dosi



Gina



Mali S-AM



Leila



Norton



Pia



Trem



Bombei M



Pla



*Lookup*  
GRUPPO RAINA

PRODOTTI | PRODUCTS

FLOOR



Amadeus



Silence



Utile



Zero



Birba



Furba

RECESSED



Demi Led



Sei



Uno



Rio



Nero



Hollow

TABLE LAMP



Lina



Squadra



Sphere



Stilo



[www.grupporaina.it/lookup](http://www.grupporaina.it/lookup)

# STRADALI | STREET LIGHTS

# COLOMBO

GRUPPO RAINA

PRODOTTI | PRODUCTS



Ellp XS



Ellp M



Ellp XL



Box



Maled



Zodiac



Zodiac XS



Zodiac XSS



Markus



Markus D



Markus P



Brownie R



Brownie T



Brownie D



Brownie O



Iron



[www.grupporaina.it/it/colombo](http://www.grupporaina.it/it/colombo)



# PROIETTORI | FLOODLIGHTS

# COLOMBO

GRUPPO RAINA

PRODOTTI | PRODUCTS



Moka 1



Moka 2



Moka XL



Walley Xp 1



Walley Xp 2



Walley Xp 4



Walley Xp 6



Megalux 8



Megalux 12



Guru Tecno



Guru AS-R



Guru Pro AS-R



[www.grupporaina.it/it/colombo](http://www.grupporaina.it/it/colombo)

AGENTE CHIMICO	CHEMICAL AGENT	POLICARBONATO (PP)   POLYCARBONATE		
		RESISTENTE RESISTANT	NON RESISTENTE NOT RESISTANT	RESISTENTE MODERATAMENTE MODERATELY RESISTANT
olio diesel-nafta	diesel-naphta			•
oli minerali	mineral oils		•	
oli e grassi alimentari	dietary oils and fats			•
acetone	acetone		•	
acido acetico 10%	acetic acid 10%	•		
acido arsenico 10%	arsenic acid	•		
acido carbonico	carbonic acid		•	
acido citrico 20%	citric acid 20%	•		
acido cloridrico 1-5%	hydrochloric acid 1-5%	•		
acido cromico	chromic acid			•
acido formico 30%	formic acid 30%		•	
acido nitrico 20%	nitric acid 20%			•
acido perclorico 10%	perchloric acid 10%	•		
acido solforico 30%	sulphuric acid 30%	•		
oli siliconici	silicone acids	•		
alcol benzilico	benzyl alcohol		•	
alcol etilico	ethylene alcohol	•		
alcol isopropilico	isopropyl alcohol		•	
ammoniaca 5%	ammonia 5%		•	
anilina	aniline			•
zucchero	sugar			•
zolfo	sulphur	•		
bevande alcoliche	alcoholic drinks	•		
benzene	benzene		•	
benzolo	benzol		•	
bromo	bromine			•
bromuro di potassio	potassium bromide	•		
caustica potassio	potassium caustic		•	
cemento	concrete	•		
clima marino	marine climate	•		
cloro liquido (vapori)	liquid chlorine		•	
cloroformio	chloroform		•	
cloruro di calcio	calcium chloride	•		
cloruro di ferro	iron chloride			•
cloruro di etile	ethyl chloride		•	
cloruro di sodio	sodium chloride	•		
cloruro solforico	sulphuric chloride		•	
etiletere	ethyl ether		•	
fenolo	phenol	•		
benzina	gasoline			•
glicerina	glycerol			•
esano	hexane		•	
idrocarburi	hydrocarbone		•	
idrossido sodico 5%	sodium hydroxide 5%		•	
candeggina di soda	soda bleach	•		
mercurio	mercury		•	
metanolo	methanol	•		
nitrate di calcio	calcium nitrate	•		
nitrate di potassio	potassium nitrate	•		
ossigeno	oxygen	•		
ozono	ozone	•		
permanganato di potassio	potassium permanganate			•
petrolio	petroleum	•		
soda	soda	•		
solfo di alluminio	aluminum sulfate	•		
solfo di zinco	zinc sulfate	•		
solfo di rame	copper sulfate	•		
solfo di manganese	manganese sulfate	•		
solfo di sodio	sodium sulfate		•	
tetracloruro di carbonio	carbon tetrachloride		•	
tricloroetilene	trichloroethylene		•	
iodio	iodine		•	

AMBIENTE   ATTIVITÀ	ENVIRONMENTS   ACTIVITIES	EM (LX)	ABBAGLIAMENTO GLARE	UNIFORMITÀ (UO) UNIFORMITY	RA
<b>UFFICI</b>	<b>OFFICE</b>				
Scrittura, lettura ed elaborazione dati	<i>Writing, reading and data processing</i>	500	19	0,60	80
Postazioni CAD	<i>CAD workstations</i>	500	19	0,60	80
Disegno tecnico	<i>Technical design</i>	750	16	0,70	80
Sala conferenza e riunioni	<i>Conference and meeting rooms</i>	500	19	0,60	80
Archiviazione, copiatura, ect	<i>Filing, copying</i>	300	19	0,40	80
Banco della reception	<i>Reception</i>	300	22	0,60	80
<b>EDIFICI SCOLASTICI</b>	<b>SCHOOL BUILDINGS</b>				
Aule locale giochi e nido	<i>Classrooms games in kindergarten &amp; nursery</i>	300	22	0,40	80
Aule scolastiche	<i>Classrooms</i>	300	19	0,60	80
Aule per corsi serali e per adulti, aule per educazione artistica, auditorium e aule lettura	<i>Classrooms in night school and adult, education drawing, auditorium and reading rooms</i>	500	19	0,60	80
Lavagne e schermi bianchi o verdi (illuminazione verticale)	<i>Blackboards and white or green screen (vertical lighting)</i>	500	19	0,70	80
Laboratori	<i>Laboratory</i>	500	19	0,60	80
Aule per disegno tecnico	<i>Classrooms for technical drawing</i>	750	16	0,70	80
Aula di musica e laboratori linguistici	<i>Music classrooms and language labs</i>	300	19	0,60	80
Aula di preparazione ed officine	<i>Classrooms of preparation and workshops</i>	500	22	0,60	80
Laboratorio di informatica	<i>Computer labs</i>	300	19	0,60	80
Ingressi	<i>Entrance</i>	200	22	0,40	80
Sale comuni per studenti e aula magna	<i>Comm. rooms for students and lobby today</i>	200	22	0,40	80
Sala professori	<i>Sale professors</i>	300	1	0,60	80
Magazzini materiale didattico	<i>Warehouses teaching materials</i>	100	25	0,40	80
Palazzetti, palestre e piscine (uso generale)	<i>Halls, gyms, swimming pools (general purpose)</i>	300	22	0,60	80
Mensa	<i>Canteen</i>	200	22	0,40	80
<b>BIBLIOTECHE</b>	<b>LIBRARIES</b>				
Scaffali (illuminazione verticale)	<i>Shelves (vertical lighting)</i>	200	25	0,40	80
Posti di servizio pubblico, lettura	<i>Places of service to the public</i>	500	22	0,60	80
<b>RISTORANTI, HOTEL E MENSE</b>	<b>RESTAURANTS, HOTEL AND CANTEEN</b>				
Corridoi negli hotel	<i>Corridors for hotel</i>	100	25	0,40	80
Ristoranti self-service	<i>Self-service restaurants</i>	200	22	0,40	80
Cucina	<i>Kitchen</i>	500	22	0,60	80
Sale conferenze	<i>Conference room</i>	500	19	0,40	80
<b>ZONE DI TRANSITO E AREE GENERALI ALL'INTERNO DEGLI EDIFICI</b>	<b>AREAS OF TRANSIT AND GENERAL AREAS INSIDE BUILDINGS</b>				
Area di passaggio e corridoi (illuminazione a pavimento)	<i>Passage areas and hallway (floor lighting)</i>	100	28	0,40	40
Scale, scale mobili, ascensori e montacarichi	<i>Stairs, elevators, escalators and goods lift</i>	100	25	0,40	40
Rampe e binari di carico	<i>Ramps and loading rails</i>	150	25	0,40	40
Locali tecnici e sala interruttore	<i>Technical rooms and switch room</i>	200	25	0,40	60
<b>INDUSTRIALI ED ARTIGIANALI</b>	<b>INDUSTRIAL AND CRAFT</b>				
<b>AGRICOLTURA</b>	<b>AGRICULTURE</b>				
Edifici per bestiame	<i>Buildings for cattle</i>	50	-	0,40	80
Carico e manovra delle merci, uso di attrezzatura	<i>Loading and operating goods, machinery handling</i>	200	25	0,40	80
Preparazione mangime, caseifici, lavaggio utensili, celle parto e zone animali	<i>Preparing food, dairy, washing utensils, cell parto and areas for animals</i>	200	25	0,60	80
<b>INDUSTRIA CHIMICA, DELLA PLASTICA E DELLA GOMMA</b>	<b>CHEMICAL INDUSTRY, PLASTIC AND RUBBER</b>				
Luoghi di lavoro con presenza di personale	<i>Workplaces with continuous presence of staff</i>	300	25	0,40	80

AMBIENTE   ATTIVITÀ	ENVIRONMENTS   ACTIVITIES	EM (LX)	ABBAGLIAMENTO GLARE	UNIFORMITÀ (UO) UNIFORMITY	RA
Produzione farmaceutica e produzione di pneumatici	<i>Pharmaceutical and tires production</i>	500	22	0,60	80
Ambienti per misurazione di precisione e laboratori	<i>Laboratory for precision measurement</i>	500	19	0,60	80
Taglio, finitura e controllo	<i>Cutting, finishing and control</i>	750	19	0,70	80
Ispezione colore	<i>Check colour</i>	1000	16	0,70	90
<b>INDUSTRIA ALIMENTARI</b>	<b>FOOD INDUSTRY</b>				
Fabbriche di birra, conserve, cioccolato, zucchero, fermentazione di tabacco e cantine di fermentazione	<i>Breweries, tinned, chocolate, sugar, fermentation of tobacco and fermentation cellars</i>	200	25	0,40	80
Selezione e lavaggio prodotti. Confezionamento. Taglio e selezione di vegetali e frutta	<i>Selection and cleaning products. Packaging. Cutting and selection of vegetables and fruit</i>	300	25	0,60	80
Produzione gastronomica, lavori di cucina, produzione sigari e sigarette	<i>Gastronomic production, kitchen work, manufacture cigarettes</i>	500	22	0,60	80
Postazione di lavoro in macellerie, caseifici e mulini	<i>Workstations in butchers, dairies and mills</i>	500	25	0,60	80
Controllo di vetri e bottiglie. Controllo prodotti	<i>Check of glass and bottles. Check product</i>	500	22	0,60	80
Ispezione colore	<i>Check colour</i>	1000	16	0,70	90
<b>LAVORAZIONE E TRASFORMAZIONE METALLI. INDUSTRIA ELETTRICA ED ELETTRONICA</b>	<b>MANUFACTURING AND PROCESSING METALS. ELECTRICAL AND ELECTRONICS INDUSTRY</b>				
Lavorazione a macchina grossolana e media	<i>Coarse and medium machine manufacturing</i>	300	22	0,60	80
Lavorazione a macchina di precisione	<i>Fine machine manufacturing</i>	500	19	0,70	80
Fucinatura a stampo, saldatura, costruzione tubi, formatura a freddo e laboratorio di trafilatura	<i>Forging mold, welding, pipe construction, cold forming and wire drawing workshop</i>	300	25	0,60	80
Trancitura, ispezione, fabbricazione utensili e ambienti da taglio	<i>Tracking, check, ,utensil and cutting tool manufacturing</i>	750	19	0,60	80
Galvanizzazione, fabbricazione cavi e fili, impregnazione delle bobine	<i>Galvanization, manufacture of cable and wires, impregnation of coils</i>	300	25	0,60	80
Assemblaggio grossolano (lav. metalli)	<i>Coarse assembly (processing metals)</i>	200	25	0,60	80
Assemblaggio grossolano (industria elettrica) e medio (lavorazione metalli)	<i>Coarse assembly (electrical industry) and medium assembly (processing metals)</i>	300	25	0,60	80
Assemblaggio medio (industria elettrica) e fine (lavorazione metalli)	<i>Medium assembly (electrical industry) and fine assembly (processing metals)</i>	500	22	0,60	80
Assemblaggio fine (industria elettrica) e di precisione (lavorazione metalli)	<i>Fine assembly (electrical industry) and precise assembly (processing metals)</i>	750	19	0,70	80
Assemblaggio di precisione (industria elettrica)	<i>Precise assembly ( electrical industry)</i>	1000	16	0,70	80
Preparazione superfici e verniciatura	<i>Surface preparation and painting</i>	750	25	0,70	80
<b>CENTRALI ELETTRICHE</b>	<b>POWER STATIONS</b>				
Impianti alimentazione combustibile	<i>Combustible power plant</i>	50	-	0,40	20
Locale caldaie	<i>Boiler room</i>	100	28	0,40	40
Sala macchine	<i>Machine room</i>	200	25	0,40	80
Locali pompe, condensatori, quadri di controllo	<i>Pump rooms, condensers, control panels</i>	200	25	0,40	60
Sale di controllo	<i>Control rooms</i>	500	16	0,70	80
<b>LAVORAZIONE E MANIFATTURA TESSILE</b>	<b>LAMINATION AND TEXTILE MANUFACTURING</b>				
Zona di lavoro a lato delle vasche	<i>Working area at wash tubs</i>	200	25	0,60	60

AMBIENTE   ATTIVITÀ	ENVIRONMENTS   ACTIVITIES	EM (LX)	ABBAGLIAMENTO GLARE	UNIFORMITÀ (UO) UNIFORMITY	RA
Lavaggio, stiratura, filatura, incollaggio	<i>Washing, ironing, spinning, bonding</i>	300	22	0,60	80
Filatura, aspatura, bobinatura, finitura, intrecciatura, tintura e tessitura. Manifattura cappelli	<i>Spinning, reeling, spooling, finishing, braiding, dyeing, weaving. Hat manufacturing</i>	500	22	0,60	80
Cucitura, maglieria fine, rimagliatura e rammendo	<i>Seaming, fine knitting, hooking and mending</i>	750	22	0,70	80
<b>COSTRUZIONE VEICOLO</b>	<b>VEHICLE CONSTRUCTION</b>				
Servizi generali per veicoli, riparazione e verifica	<i>General Vehicle Services, Repair and Inspection</i>	300	22	0,60	80
Carrozzeria ed assemblaggio	<i>Bodywork and assembly</i>	500	22	0,60	80
Camera di verniciatura, spruzzatura, lucidatura	<i>Paint chamber, polishing</i>	750	22	0,70	80
Verniciatura (ritocco, controllo), fabbricazione rivestimenti interni e controllo finale	<i>Painting (touch up, control), Inner lining manufacturing, final control</i>	1000	19	0,70	80
<b>LAVORAZIONE E MANIFATTURA DI LEGNO</b>	<b>WOOD MANUFACTURING AND PROCESSING</b>				
Processi automatici	<i>Automatic processes</i>	50	28	0,40	40
Camera del vapore	<i>Steam rooms</i>	150	28	0,40	40
Sega	<i>Saw</i>	300	25	0,60	60
Lavori dal banco di falegnameria, incollaggio e assemblaggio	<i>Counter work, assembly</i>	300	25	0,60	80
Lucidatura, verniciatura	<i>Polishing, painting</i>	750	22	0,70	80
Lavorazione su macchine	<i>Machine manufacturing</i>	500	19	0,60	80
Selezione legno per impiallacciatura, intarsio	<i>Wood selection, inlay</i>	750	22	0,70	90
Verifica di controllo ed ispezione	<i>Quality control, inspection</i>	1000	19	0,70	90
<b>MAGAZZINI - MAGAZZINI REFRIGERANTI</b>	<b>WAREHOUSES - REFRIGERATED WAREHOUSES</b>				
Zone di stoccaggio	<i>Storage areas</i>	100	25	0,40	60
Zona di movimentazione, imballaggio, spedizione	<i>Movement areas, packaging, shipping</i>	300	25	0,60	60
Magazzini con scaffali - passaggio con presenza di personale (ill. a pavimento)	<i>Warehouses with shelves - staff presence passage (floor lighting)</i>	150	22	0,40	60
Magazzini con scaffali - passaggio con presenza di personale (ill. a pavimento)	<i>Warehouses with shelves - no staff passage (floor lighting)</i>	150	22	0,40	40
Stazione di controllo	<i>Control station</i>	150	22	0,60	80
<b>LUOHI DI CURA</b>	<b>HEALTH AREAS</b>				
Corridoio (notte)	<i>Corridors (night)</i>	50	22	0,40	80
Corridoio (giorno)	<i>Corridors (daytime)</i>	100	22	0,40	80
Visita semplice	<i>Visit simple</i>	300	19	0,60	80
Visita e trattamento	<i>Visit and treatment</i>	1000	19	0,70	90
Locali diagnostici (illuminazione generale)	<i>Diagnostic rooms (visits and treatment)</i>	500	19	0,60	90
Locale pre-operatorio e risveglio	<i>Pre-operating room</i>	500	19	0,60	90
Sala operatoria	<i>Operating room</i>	1000	19	0,60	90
Laboratorio, farmacia (illuminazione generale), ufficio per il personale	<i>Laboratory, pharmacy (general lighting), staff office</i>	500	19	0,60	80
Massaggio, radioterapia, endoscopia, esami semplici	<i>Massage, radiotherapy, endoscopy, simple exams</i>	300	19	0,60	80
Infermeria, ingessatura, dialisi	<i>Infirmery, plaster, dialysis</i>	500	19	0,60	80
Odontoiatria (illuminazione generale), dermatologia	<i>Dentistry (general illumination), dentology</i>	500	19	0,60	90
Sala di sterilizzazione e disinfezione	<i>Room for sterilization and disinfection</i>	300	22	0,60	80

AMBIENTE   ATTIVITÀ	ENVIRONMENTS   ACTIVITIES	EM (LX)	ABBAGLIAMENTO GLARE	UNIFORMITÀ (UO) UNIFORMITY	RA
<b>PARCHEGGI PUBBLICI</b>	<b>COVERED PARKING</b>				
Rampe di ingresso/uscita (durante il giorno)	Entry/exit ramp (daytime)	300	25	0,40	10
Rampe di ingresso/uscita (durante la notte)	Entry/exit ramp (night)	75	25	0,40	40
Corsie di circolazione	Circulations lanes	75	25	0,40	40
Zone di parcheggio	Parking zones	75	-	0,40	40
Biglietteria	Ticket office	300	19	0,60	80
<b>AEROPORTI</b>	<b>AIRPORT</b>				
Zone di collegamento	Connection areas	150	22	0,40	80
Sala di attesa, Sala di arrivo e partenza, zona ritiro bagagli	Waiting room, Arrival and departure room, baggage claim area	200	22	0,40	80
Banchi informazioni, accettazione, dogana e controllo passaporti	Information banks, acceptance, customs and passport control	500	19	0,70	80
Deposito bagagli	Baggage storage	200	25	0,40	80
Zone di controllo di sicurezza	Safety control zone	300	19	0,60	80
<b>STAZIONI FERROVIARIE</b>	<b>RAILWAY STATIONS</b>				
Banchine, bassa di densità di persone	Quay, low density of people	100	-	0,40	40
Banchine, alta densità di persone	Quay, high density of people	200	-	0,50	60
Sottopassaggi, bassa di densità di persone	Subway, low density of people	50	28	0,50	40
Sottopassaggi, alta densità di persone	Subway, high density of people	100	28	0,50	40
Biglietteria, deposito bagagli, cassa	Ticket office, baggage storage, cash	300	19	0,50	80
Sala d'attesa	Waiting room	200	22	0,40	80
Ingressi, sale stazione	Entrance, station room	200	-	0,40	80
Gallerie d'accesso	Access tunnel	50	-	0,40	20
<b>AMBIENTI SPORTIVI AL COPERTO (C.O.N.I.) - norma EN 12193</b>	<b>OPEN SPORT AREAS ( C.O.N.I.) - norm EN 12193</b>				
Atletica leggera (non agonistico)	Athletics ( not agonistic)	200	-	0,50	-
Atletica leggera (agonistico a liv. locale)	Athletics ( agonistic at the local level)	300	-	0,60	-
Atletica leggera (agonistico a livello nazionale od internazionale)	Athletics ( agonistic at national or international level)	500	-	0,70	-
Attività natatorie (non agonistico)	Swimming activities (not agonistic)	200	-	0,50	-
Attività natatorie (agonistico a livello locale)	Swimming activities (agonistic at the local level)	300	-	0,70	-
Attività natatorie (agonistico a livello nazionale od internazionale)	Swimming activities (agonistic at national or international level)	500	-	0,70	-
Calcio a 5 (non agonistico)	5-a-side football ( not agonistic)	200	-	0,50	-
Calcio a 5 (agonistico a livello locale)	5-a-side football ( agonistic at the local level)	500	-	0,70	-
Calcio a 5 (agonistico a livello nazionale od internazionale)	5-a-side football ( agonistic at national or international level)	750	-	0,70	-
Pallacanestro, Pallavolo, Pallamano, Lotta, Pesistica, Judo (non agonistico)	Basket, Volleyball, handball, fight, weightlifting, judo (not agonistic)	200	-	0,50	-
Pallacanestro, Pallavolo, Pallamano, Lotta, Pesistica, Judo (agonistico a livello locale)	Basket, Volleyball, handball, fight, weightlifting, judo (agonistic at the local level)	500	-	0,70	-
Pallacanestro, Pallavolo, Pallamano, Lotta, Pesistica, Judo (agonistico a livello nazionale od internazionale)	Basket, Volleyball, handball, fight, weightlifting, judo (agonistic at national or international level)	750	-	0,70	-
Tennis (non agonistico)	Tennis (not agonistic)	300	-	0,50	-
Tennis (agonistico a livello locale)	Tennis (agonistic at the local level)	500	-	0,70	-
Tennis (agonistico a livello nazionale od internazionale)	Tennis (agonistic at national or international level)	750	-	0,70	-



AMBIENTE   ATTIVITÀ	ENVIRONMENTS   ACTIVITIES	EM (LX)	ABBAGLIAMENTO GLARE	UNIFORMITÀ (UO) UNIFORMITY	RA
<b>AMBIENTI SPORTIVI ALL'ESTERNO (C.O.N.I.) - norma EN 12193</b>	<b>CLOSE SPORT AREAS ( C.O.N.I.) - norm EN 12193</b>				
Atletica leggera (non agonistico)	<i>Athletics ( not agonistic)</i>	100		0,50	
Atletica leggera (agonistico a livello locale)	<i>Athletics ( agonistic at the local level)</i>	200		0,50	
Atletica leggera (agonistico a livello nazionale od internazionale)	<i>Athletics ( agonistic at national or international level)</i>	500		0,70	
Attività natatoie (non agonistico)	<i>Swimming activities (not agonistic)</i>	200		0,50	
Attività natatoie (agonistico a livello locale)	<i>Swimming activities (agonistic at the local level)</i>	300		0,70	
Attività natatoie (agonistico a livello nazionale od internazionale)	<i>Swimming activities (agonistic at national or international level)</i>	500		0,70	
Calcio (non agonistico)	<i>5-a-side football ( not agonistic)</i>	75		0,50	
Calcio (agonistico a livello locale)	<i>5-a-side football ( agonistic at the local level)</i>	200		0,60	
Calcio (agonistico a livello nazionale od internazionale)	<i>5-a-side football ( agonistic at national or international level)</i>	500		0,70	
Calcio a 5 (non agonistico)	<i>Football (not agonistic)</i>	100		0,50	
Calcio a 5 (agonistico a livello locale)	<i>Football (agonistic at the local level)</i>	200		0,70	
Calcio a 5 (agonistico a livello nazionale od internazionale)	<i>Football (agonistic at national or international level)</i>	500		0,70	
Pallacanestro, Pallavolo, Pallamano, Lotta, Pesistica, Judo (non agonistico)	<i>Basket, Volleyball, handball, fight, weightlifting, judo (not agonistic)</i>	100		0,50	
Pallacanestro, Pallavolo, Pallamano, Lotta, Pesistica, Judo (agonistico a livello locale)	<i>Basket, Volleyball, handball, fight, weightlifting, judo (agonistic at the local level)</i>	200		0,60	
Pallacanestro, Pallavolo, Pallamano, Lotta, Pesistica, Judo (agonistico a livello nazionale od internazionale)	<i>Basket, Volleyball, handball, fight, weightlifting, judo (agonistic at national or international level)</i>	500		0,70	
Tennis (non agonistico)	<i>Tennis (not agonistic)</i>	200		0,60	
Tennis (agonistico a livello locale)	<i>Tennis (agonistic at the local level)</i>	300		0,70	
Tennis (agonistico a livello nazionale od internazionale)	<i>Tennis (agonistic at national or international level)</i>	500		0,70	
<b>AREE ESTERNE (CIE 129)</b>	<b>EXTERNAL AREAS (CIE 129)</b>				
Parcheggi di negozi, di scuole e condominiali	<i>Store, school and condo parking lots</i>		5		
Lavoro molto grezzo, carico e scarico	<i>Rough work, loading and unloading</i>		20		
Lavoro grezzo, trasporto e immagazzinamento	<i>Rough work, transportation and storage</i>		50		
Camminamenti per pedoni	<i>Pedestrian walkways</i>		5		

Codice	Code	p.	Codice	Code	p.	Codice	Code	p.	Codice	Code	p.	Codice	Code	p.
7511/10		174	AGLT2029P		20	AMSO2021		26	ASST2010P		24	BDS2249PS		186
7511/20		174	AGLT2030T		20	AMSO2029		26	ASST2014L		24	BDS2258		184
7511/30		174	AGLT2039X		20	AMST2010L		28	ASST2014P		24	BDS2258PS		186
AAL17		146	AGLT2042T		20	AMST2010P		28	ASST2015T		24	BDS2264		184
AAL19		146	AGLT2057X		20	AMST2014L		28	ASST2020X		24	BDS2264PS		186
AAL217		147	AGSMP2020		19	AMST2014P		28	ASST2021T		24	BDS24116		184
AAL219		147	AGSMP2029		19	AMST2015T		28	ASST2029X		24	BDS24116PS		186
AAL223		147	AGSMP2030		19	AMST2020X		28	BA12		168	BDS24128		184
AAL228		147	AGSMP2039		19	AMST2021T		28	BA15		168	BDS24128PS		186
AAL23		146	AGSMP2042		19	AMST2029X		28	BA20		168	BDS249		184
AAL233		147	AGSMP2057		19	AMU100		208	BA24		168	BDS2498		184
AAL243		147	AGSO2020		18	AMU132		208	BA29		168	BDS2498PS		186
AAL251		147	AGSO2029		18	AMU33		208	BA30		168	BDS249PS		186
AAL28		146	AGSO2030		18	AMU43		208	BA33		168	BDS258		184
AAL317		148	AGSO2039		18	AMU50		208	BBL22		49	BDS258PS		186
AAL319		148	AGSO2042		18	AMU60		208	BBL29		49	BDS264		184
AAL323		148	AGSO2057		18	AMU66		208	BBL33		49	BDS264PS		186
AAL328		148	AMCMP2010		13	AMU80		208	BBL44		49	BDS298		184
AAL33		146	AMCMP2014		13	ASMMP2010		11	BBL45		49	BDS298PS		186
AAL333		148	AMCMP2015		13	ASMMP2014		11	BBL58		49	BLS11		188
AAL343		148	AMCMP2020		13	ASMMP2015		11	BBT22		48	BLS11		189
AAL351		148	AMCMP2021		13	ASMMP2020		11	BBT29		48	BLS11		190
AAL43		146	AMCMP2029		13	ASMMP2021		11	BBT33		48	BLS12		188
AAL51		146	AMCMP5010		95	ASMMP2029		11	BBT44		48	BLST2		189
AD70		112	AMCMP5014		95	ASMMP5010		93	BBT45		48	BLST2		190
AD750		112	AMCMP5015		95	ASMMP5014		93	BBT58		48	BLST3		188
AD75UGN		112	AMCMP5021		95	ASMMP5015		93	BDL13		182	BLST3		189
AD7UGN		112	AMCMP5029		95	ASMMP5021		93	BDL15		182	BLST3		190
AGLMP2020		9	AMCMP5050		95	ASMMP5029		93	BDL17		182	BLS21		188
AGLMP2029		9	AMCO2010		12	ASMMP5050		93	BDL18		182	BLS21		189
AGLMP2030		9	AMCO2014		12	ASMO2010		10	BDL22		182	BLS21		190
AGLMP2039		9	AMCO2015		12	ASMO2014		10	BDL226		182	BLS22		188
AGLMP2042		9	AMCO2020		12	ASMO2015		10	BDL230		182	BLS22		189
AGLMP2057		9	AMCO2021		12	ASMO2020		10	BDL234		182	BLS22		190
AGLMP5020		91	AMCO2029		12	ASMO2021		10	BDL236		182	BLS23		188
AGLMP5029		91	AMCO5010		94	ASMO2029		10	BDL244		182	BLS23		189
AGLMP5030		91	AMCO5014		94	ASMO5010		92	BDL249		182	BLS23		190
AGLMP5039		91	AMCO5015		94	ASMO5014		92	BDL25		182	BLS31		188
AGLMP5042		91	AMCO5021		94	ASMO5015		92	BDL250		182	BLS31		189
AGLMP5057		91	AMCO5029		94	ASMO5021		92	BDL258		182	BLS31		190
AGLO2020		8	AMCO5050		94	ASMO5029		92	BDL26		182	BLS32		188
AGLO2029		8	AMI100		209	ASMO5050		92	BDL264		182	BLS32		189
AGLO2030		8	AMI132		209	ASSMP2010		23	BDL30		182	BLS32		190
AGLO2039		8	AMI50		209	ASSMP2014		23	BDL34		182	BLS33		188
AGLO2042		8	AMI66		209	ASSMP2015		23	BDS1149		184	BLS33		189
AGLO2057		8	AMSM2010		27	ASSMP2020		23	BDS1158		184	BLS33		190
AGLO5020		90	AMSM2014		27	ASSMP2021		23	BDS1164		184	BLS41		188
AGLO5029		90	AMSM2015		27	ASSMP2029		23	BDS124		184	BLS41		189
AGLO5030		90	AMSM2020		27	ASSO2010		22	BDS129		184	BLS41		190
AGLO5039		90	AMSM2021		27	ASSO2014		22	BDS133		184	BLS42		188
AGLO5042		90	AMSM2029		27	ASSO2015		22	BDS2116		184	BLS42		189
AGLO5057		90	AMSO2010		26	ASSO2020		22	BDS2116PS		186	BLS42		190
AGLT2020L		20	AMSO2014		26	ASSO2021		22	BDS2128		184	BLS43		188
AGLT2020P		20	AMSO2015		26	ASSO2029		22	BDS2128PS		186	BLS43		189
AGLT2029L		20	AMSO2020		26	ASST2010L		24	BDS2249		184	BLS43		190

Codice	Code	p.	Codice	Code	p.	Codice	Code	p.	Codice	Code	p.	Codice	Code	p.
BOL140		221	CPM30		104	DR201		129	FLL57DI		42	INAS27		275
BOL185		221	CPM36		104	DR202		129	FLS270		50	INAS40		275
BOL270		221	CPM42		104	DR203		129	FLS380		50	INAS53		275
BOL64		221	CPM49		104	DR204		129	FLS450		50	INASPI4		275
BOL85		221	CPM50		104	DR205		129	FUIP8		214	INASP20		275
BOSH40		63	CPM60		104	DR206		129	FUIP9		214	INASP26		275
BOSH64		63	CPM80		104	DR207		129	FUL10MP		210	INASP27		275
BOSH85		63	CPM85		104	DR233		128	FUL14MP		211	INASP40		275
BSIP33		59	CPO30		105	DR234		128	FUL6MP		210	INASP53		275
BSIP43		59	CPO36		105	DR235		128	FUL8MP		211	INATLP1		278
BSIP64		59	CPO42		105	DR236		128	FUL9MP		211	INATLP2		278
BSK33		58	CPO49		105	DR237		128	FULS4MP		212	INATLP3		278
BSK43		58	CPO50		105	DR238		128	FULS7MP		212	INATLP4		278
BSK64		58	CPO60		105	DR239		128	GDL270		51	INATT1		278
CCL40		64	CPO80		105	EB10		98	GDL370		51	INATT2		278
CCL64		64	CP085		105	EB20		98	GRL17		149	INATT3		278
CCL85		64	CPRM10		107	EB22		98	GRL19		149	INATT4		278
CCPM19		109	CPRM11		107	EB29		98	GRL217		150	INCC20		273
CCPM23		109	CPRM12		107	EB44		98	GRL219		150	INCC27		273
CCPM27		109	CPRM30		107	EB58		98	GRL223		150	INCC40		273
CCPM30		109	CPRM36		107	EBD10		96	GRL228		150	INCC53		273
CF30MP		102	CPRM42		107	EBD20		96	GRL23		149	INCCP20		273
CF36MP		102	CPRM49		107	EBD22		96	GRL233		150	INCCP27		273
CF42MP		102	CPRO10		108	EBD29		96	GRL243		150	INCCP40		273
CLK19		120	CPRO11		108	EBD44		96	GRL251		150	INCCP53		273
CLK19		121	CPRO12		108	EBD58		96	GRL28		149	INDK24		241
CLK19		122	CPRO30		108	EBM10		97	GRL317		151	INDK30		241
CLK23		120	CPRO36		108	EBM20		97	GRL319		151	INDK43		241
CLK23		121	CPRO42		108	EBM22		97	GRL323		151	INDK50		241
CLK23		122	CPRO49		108	EBM29		97	GRL328		151	INDK57		241
CLK28		120	DAHFI1		71	EBM44		97	GRL33		149	INDK66		241
CLK28		121	DAHFI2		71	EBM58		97	GRL333		151	ING030		290
CLK28		122	DAHFI3		71	EN01		137	GRL343		151	ING032		290
CLK33		120	DAHFI4		71	EN02		137	GRL351		151	ING033		290
CLK33		121	DAHFI5		71	EN02		137	GRL43		149	ING034		290
CLK33		122	DHF11		70	EN03		137	GRL51		149	ING037		290
CLK43		120	DHF12		70	EN04		137	IC101		133	ING039		290
CLK43		121	DHF13		70	EN05		137	IC102		133	ING040		290
CLK43		122	DHF14		70	FFD33		40	IC103		133	ING042		290
CLK51		120	DHF15		70	FFD43		40	IC104		133	INGOP11		288
CLK51		121	DN441L65		216	FFD44		40	IC121		132	INGOP12		288
CLK51		122	DN441L85		216	FFD48		40	IC122		132	INGOP14		288
CMSA2L40		100	DNE150		219	FFD58		40	IC123		132	INGOP30		290
CMSA2L48		100	DNE170		219	FFD64		40	IC124		132	INGOP32		290
CMSA2L56		100	DNE185		219	FFI33		41	INAPLP1		279	INGOP33		290
CMSA40		99	DNEC150		218	FFI43		41	INAPLP2		279	INGOP34		290
CMSA48		99	DNLI140		217	FFI44		41	INAPLP3		279	INGOP37		290
CMSA56		99	DNLI185		217	FFI48		41	INAPLP4		279	INGOP39		290
CMSAR40		101	DNLI270		217	FFI58		41	INAPLT1		279	INGOP4		288
CMSAR48		101	DO12		171	FFI64		41	INAPT2		279	INGOP40		290
CMSAR56		101	DO15		171	FKLI5		158	INAPT3		279	INGOP42		290
CPIN30		110	DO20		171	FKLI5		158	INAPT4		279	INGOP5		288
CPIN36		110	DO24		171	FLL43D		42	INAS14		275	INGOP6		288
CPIN42		110	DO29		171	FLL43DI		42	INAS20		275	INGOP9		288
CPIN49		110	DO30		171	FLL57D		42	INAS26		275	INGI1		284

Codice	Code	p.	Codice	Code	p.	Codice	Code	p.	Codice	Code	p.	Codice	Code	p.
ING12		284	INGP20		285	INGRP33		294	INLPRP23		266	INPKP43		274
ING14		284	INGP23		285	INGRP34		294	INLPRP33		267	INPKP57		274
ING16		285	INGP25		285	INGRP37		294	INLPRP43		266	INPKT34		274
ING18		285	INGP26		285	INGRP39		294	INMG10		251	INPKT50		274
ING19		285	INGP28		285	INGRP4		292	INMG12		250	INPKT66		274
ING2		284	INGP30		286	INGRP40		294	INMG2		251	INPKTP34		274
ING20		285	INGP32		286	INGRP42		294	INMG3		251	INPKTP50		274
ING23		285	INGP33		286	INGRP5		292	INMG4		250	INPKTP66		274
ING25		285	INGP34		286	INGRP6		292	INMG5		251	INPKXS22		274
ING26		285	INGP37		286	INGRP9		292	INMG6		250	INPKXS33		274
ING28		285	INGP39		286	INI17		272	INMG7		250	INPKXS43		274
ING30		286	INGP4		284	INI22		272	INMG010		253	INPKXSP22		274
ING32		286	INGP40		286	INI25		272	INMG012		252	INPKXSP33		274
ING33		286	INGP42		286	INI33		272	INMG02		253	INPKXSP43		274
ING34		286	INGP5		284	INI43		272	INMG03		253	INSH1101		302
ING37		286	INGP6		284	INI50		272	INMG04		252	INSH1102		302
ING39		286	INGP9		284	INIP17		272	INMG05		253	INSH1103		302
ING4		284	INGR11		292	INIP22		272	INMG06		252	INSH1104		302
ING40		286	INGR12		292	INIP25		272	INMG07		252	INSH1105		302
ING42		286	INGR14		292	INIP33		272	INMGOP		252	INSH1106		302
ING5		284	INGR16		293	INIP43		272	INMGOP		253	INSH241		304
ING6		284	INGR18		293	INIP50		272	INMGOP10		253	INSH242		304
ING9		284	INGR19		293	INIT22		272	INMGOP2		252	INSH243		304
INGO11		288	INGR2		292	INIT29		272	INMGOP3		253	INSH244		304
INGO12		288	INGR20		293	INIT34		272	INMGOP5		253	INSH481		303
INGO14		288	INGR23		293	INIT43		272	INMGOP6		252	INSH482		303
INGO16		289	INGR25		293	INIT57		272	INMGOP7		252	INSH483		303
INGO18		289	INGR26		293	INIT66		272	INMGPI0		251	INSH484		303
INGO19		289	INGR28		293	INITP22		272	INMGPI2		250	INSH485		303
INGO2		288	INGR30		294	INITP29		272	INMGPI2		251	INSH486		303
INGO20		289	INGR32		294	INITP34		272	INMGPI3		251	INSHH10		280
INGO23		289	INGR33		294	INITP43		272	INMGPI4		250	INSHH11		280
INGO25		289	INGR34		294	INITP57		272	INMGPI5		251	INSHH12		280
INGO26		289	INGR37		294	INITP66		272	INMGPI6		250	INSHH14		280
INGO28		289	INGR39		294	INLPO16		263	INMGPI7		250	INSHH16		280
INGO4		288	INGR4		292	INLPO33		263	INMGPI0		255	INSHH9		280
INGO5		288	INGR40		294	INLPOP16		263	INMGRI0		255	INSP021		263
INGO6		288	INGR42		294	INLPOP33		263	INMGRI2		254	INSP040		263
INGO9		288	INGR5		292	INLP16		259	INMGRI2		254	INSPOP21		263
INGOP16		289	INGR6		292	INLP23		258	INMGRI2		255	INSPOP40		263
INGOP18		289	INGR9		292	INLP33		259	INMGRI2		255	INSP10		260
INGOP19		289	INGRP11		292	INLP43		258	INMGRI3		255	INSP20		260
INGOP2		288	INGRP12		292	INLPO23		262	INMGRI3		255	INSP21		259
INGOP20		289	INGRP14		292	INLPO43		262	INMGRI4		254	INSP27		258
INGOP23		289	INGRP16		293	INLPOP23		262	INMGRI4		254	INSP40		259
INGOP25		289	INGRP18		293	INLPOP43		262	INMGRI5		255	INSP54		258
INGOP26		289	INGRP19		293	INLPP16		259	INMGRI5		255	INSP010		264
INGOP28		289	INGRP2		292	INLPP23		258	INMGRI6		254	INSP020		264
INGPI1		284	INGRP20		293	INLPP33		259	INMGRI6		254	INSP027		262
INGPI2		284	INGRP23		293	INLPP43		258	INMGRI7		254	INSP054		262
INGPI4		284	INGRP25		293	INLPR16		267	INMGRI7		254	INSPOP27		262
INGPI6		285	INGRP26		293	INLPR23		266	INPK29		274	INSPOP54		262
INGPI8		285	INGRP28		293	INLPR33		267	INPK43		274	INSP21		259
INGPI9		285	INGRP30		294	INLPR43		266	INPK57		274	INSP27		258
INGP2		284	INGRP32		294	INLPRP16		267	INPK29		274	INSP40		259

Codice	Code	p.	Codice	Code	p.	Codice	Code	p.	Codice	Code	p.	Codice	Code	p.
INSPP54		258	INTTRP27		267	INXLTTI96		240	IZGP16(..*)3P		328	IZUTR2		322
INSRP10		268	INTTRP36		266	INXLXP110		235	IZGP5(..*)5P		330	IZUTR5		322
INSRP20		268	INTTRP54		267	INXLXP145		234	IZGP6(..*)5P		330	IZUTRP2		322
INSRP21		267	INTTRP73		266	INXLXP150		235	IZT1		320	IZUTRP5		322
INSRP27		266	INUT15		298	INXLXP200		234	IZT1(..*)3P		324	JRM17		60
INSRP40		267	INUT17		298	INXLXP0110		239	IZT1(..*)5P		326	JRM19		60
INSRP54		266	INUT19		298	INXLXP0145		238	IZT2		320	JRM23		60
INSRP21		267	INUT21		298	INXLXP0150		239	IZT2(..*)3P		324	JWEI5		159
INSRP27		266	INUT26		298	INXLXP0200		238	IZT2(..*)5P		326	JWEI5		159
INSRP40		267	INUT37		298	INXLXP0P110		239	IZT3		320	LA12		169
INSRP54		266	INUT40		298	INXLXP0P145		238	IZT3(..*)3P		324	LA15		169
INTN025		263	INUT51		298	INXLXP0P150		239	IZT3(..*)5P		326	LA20		169
INTN050		263	INUTO15		299	INXLXP0P200		238	IZT4		320	LA24		169
INTNOP25		263	INUTO17		299	INXLXPP110		235	IZT4(..*)3P		324	LA29		169
INTNOP50		263	INUTO19		299	INXLXPP145		234	IZT4(..*)5P		326	LA30		169
INTN25		259	INUTO21		299	INXLXPP150		235	IZT5		320	LUDL140		220
INTN34		258	INUTO26		299	INXLXPP200		234	IZT5(..*)3P		324	LUDL185		220
INTN50		259	INUTO37		299	INXP020		263	IZT5(..*)5P		326	LUDL270		220
INTN66		258	INUTO40		299	INXP040		263	IZT6		320	LUDL64		220
INTNO34		262	INUTO51		299	INXP0P20		263	IZT6(..*)3P		324	LUDL85		220
INTNO66		262	INXLLPI56		240	INXP0P40		263	IZT6(..*)5P		326	LUSH40		62
INTNOP34		262	INXLLPI74		240	INXP10		260	IZTP1(..*)3P		324	LUSH64		62
INTNOP66		262	INXLMGI04		235	INXP20		259	IZTP1(..*)5P		326	LUSH85		62
INTNP25		259	INXLMGI140		234	INXP27		258	IZTP2(..*)3P		324	MAIL15		154
INTNP34		258	INXLMGI155		235	INXP40		259	IZTP2(..*)5P		326	MAIL15		154
INTNP50		259	INXLMGI180		235	INXP40VK35		246	IZTP3(..*)3P		324	MA2L15		155
INTNP66		258	INXLMG200		234	INXP53		258	IZTP3(..*)5P		326	MA2L15		155
INTNR25		267	INXLMG240		234	INXP53VK35		246	IZTP4(..*)3P		324	MA3L15		156
INTNR34		266	INXLMGO104		239	INXP010		264	IZTP4(..*)5P		326	MA3L15		156
INTNR50		267	INXLMGO140		238	INXP027		262	IZTP5(..*)3P		324	MBL15		160
INTNR66		266	INXLMGO155		239	INXP053		262	IZTP5(..*)5P		326	MBL15		160
INTNRP25		267	INXLMGO180		239	INXP0P27		262	IZTP6(..*)3P		324	MF30MP		103
INTNRP34		266	INXLMGO200		238	INXP0P53		262	IZTP6(..*)5P		326	MF36MP		103
INTNRP50		267	INXLMGO240		238	INXPP20		259	IZTR1		322	MF42MP		103
INTNRP66		266	INXLMG0P104		239	INXPP27		258	IZTR2		322	MGR17		152
INTT027		263	INXLMG0P140		238	INXPP40		259	IZTR3		322	MGR19		152
INTT054		263	INXLMG0P155		239	INXPP53		258	IZTR4		322	MGR120		152
INTTOP27		263	INXLMG0P180		239	INXPR10		268	IZTR5		322	MGR124		152
INTTOP54		263	INXLMG0P200		238	INXPR20		267	IZTR6		322	MGR128		152
INTT27		259	INXLMG0P240		238	INXPR27		266	IZTRP1		322	NR201		126
INTT36		258	INXLMGP104		235	INXPR40		267	IZTRP2		322	NR201		127
INTT54		259	INXLMGP140		234	INXPR53		266	IZTRP3		322	NR202		126
INTT73		258	INXLMGP155		235	INXPRP20		267	IZTRP4		322	NR202		127
INTT036		262	INXLMGP180		235	INXPRP27		266	IZTRP5		322	NR203		126
INTT073		262	INXLMGP200		234	INXPRP40		267	IZTRP6		322	NR203		127
INTTOP36		262	INXLMGP240		234	INXPRP53		266	IZUT2		320	NR204		126
INTTOP73		262	INXLS12		242	IZGI(..*)5P		330	IZUT2(..*)3P		324	NR204		127
INTTP27		259	INXLS15		242	IZG11(..*)3P		328	IZUT2(..*)5P		326	NR205		126
INTTP36		258	INXLSM112		236	IZG15(..*)3P		328	IZUT5		320	NR205		127
INTTP54		259	INXLSM56		236	IZG16(..*)3P		328	IZUT5(..*)3P		324	NR206		126
INTTP73		258	INXLSM82		236	IZG5(..*)5P		330	IZUT5(..*)5P		326	NR206		127
INTTR27		267	INXLSM94		236	IZG6(..*)5P		330	IZUTP2(..*)3P		324	NR207		126
INTTR36		266	INXLTN110		240	IZGP1(..*)5P		330	IZUTP2(..*)5P		326	NR207		127
INTTR54		267	INXLTN180		240	IZGP11(..*)3P		328	IZUTP5(..*)3P		324	NR233		124
INTTR73		266	INXLTT1130		240	IZGP15(..*)3P		328	IZUTP5(..*)5P		326	NR233		125

Codice	Code	p.	Codice	Code	p.	Codice	Code	p.
NR234		124	RKS10		77	SP3		131
NR234		125	RKS11		77	SP4		130
NR235		124	RL17		153	SP4		131
NR235		125	RL19		153	SP5		130
NR236		124	RL23		153	SP5		131
NR236		125	RL28		153	SP6		130
NR237		124	RL33		153	SP6		131
NR237		125	RUM15		157	SP7		130
NR238		124	RUM15		157	SP7		131
NR238		125	RX08		46	SP8		130
NR239		124	RX12		46	SP8		131
NR239		125	RX34		46	SP9		130
NWI15N01		136	RX40		46	SP9		131
NWI20N01		135	RX56		46	VL12		170
NWI23N01		134	RXR03		47	VL15		170
PE256		222	RXR06		47	VL20		170
PE256		222	RXR40		47	VL24		170
PE256		222	RXR56		47	VL29		170
PE256		222	RXSA08		44	VL30		170
PE256		222	RXSA12		44			
PE306		222	RXSA34		44			
PE306		222	RXSA40		44			
PE306		222	RXSA56		44			
PE306		222	RXSAR03		45			
PE306		222	RXSAR06		45			
PE356		223	RXSAR40		45			
PE356		223	RXSAR56		45			
PE356		223	SI01		138			
PE356		223	SI02		138			
PE356		223	SI02		138			
PE506		223	SI03		138			
PE506		223	SI04		138			
PE506		223	SI05		138			
PE506		223	SML12		172			
PE506		223	SML15		172			
PL01		61	SML20		172			
PRLHF11		72	SML24		172			
PRLHF12		72	SML29		172			
PRLHF13		72	SO256		225			
PRLHF14		72	SO256		225			
PRLHF15		72	SO256		225			
RK01		76	SO256		225			
RK02		76	SO354		224			
RK03		76	SO354		224			
RK04		76	SO354		224			
RK05		76	SO354		224			
RK06		76	SO356		225			
RK10		76	SO356		225			
RK11		76	SO356		225			
RKS01		77	SO356		225			
RKS02		77	SO504		224			
RKS03		77	SO504		224			
RKS04		77	SO504		224			
RKS05		77	SO504		224			
RKS06		77	SP3		130			

Codice	Code	p.	Codice	Code	p.	Codice	Code	p.	Codice	Code	p.	Codice	Code	p.
535/P/1000		75	7PR3702-V		287	BDS		197	IN-MOL-AV		265	INHP/P/600		237
535/P/300		75	7PR3702-V		291	BDS-45		197	IN-MOL-AV		269	INHP/P/600		243
535/P/600		75	7PR3702-V		295	BDS-A		196	IN-MOL-AV		281	INHP/P/600		261
535/P/800		75	7PR3702-V		332	BDS-C		197	IN-MOL-AV		332	INHP/P/600		265
535/SP/90		75	7PR5701		237	BDS-CK-1000		198	IN-MOL-AV3		287	INHP/P/600		269
535INT		75	7PR5701		243	BDS-CK-1500		198	IN-MOL-AV3		291	INHP/P/600		287
7601-00		175	7PR5701		261	BDS-CK-2000		198	IN-MOL-AV3		295	INHP/P/600		291
7601-11		175	7PR5701		265	BDS-CK-2500		198	INI200		261	INHP/P/600		295
7604-10		175	7PR5701		269	BDS-F		196	INI200		265	INHP/P/600		332
7606-00		175	7PR5701		281	BDS-G		196	INI200		269	INHP/P/800		237
7606-02		175	7PR5701		287	BDS-KS		196	INI200		281	INHP/P/800		243
7606-04		175	7PR5701		291	BDS-KSP		196	INI200		332	INHP/P/800		261
7606-05		175	7PR5701		295	BDS-PS-CK-1000		198	INI2002		237	INHP/P/800		265
7607-00		175	7PR5701		332	BDS-PS-CK-1500		198	INI2002		243	INHP/P/800		269
7624-00		175	7PR5702-V		237	BDS-PS-CK-2000		198	INI500		261	INHP/P/800		287
7625-00		175	7PR5702-V		243	BDS-PS-CK-2500		198	INI500		265	INHP/P/800		291
7652-10		175	7PR5702-V		261	BDS-T		197	INI500		269	INHP/P/800		295
7652-11		175	7PR5702-V		265	BDSAS-F		196	INI500		281	INHP/P/800		332
7653-10		175	7PR5702-V		269	BLS		197	INI500		332	INHP5/P/1000		332
7654-10		175	7PR5702-V		281	BLS-45		197	INI5002		237	INHP5/P/300		332
7655-10		175	7PR5702-V		287	BLS-C		197	INI5002		243	INHP5/P/600		332
7655-11		175	7PR5702-V		291	BLS-CK-1122		199	INI900		287	INHP5/P/800		332
7656-10		175	7PR5702-V		295	BLS-CK-1403		199	INI900		291	ININF		237
7656-11		175	7PR5702-V		332	BLS-CK-1683		199	INI900		295	ININF		243
7656-12		175	ADKP01		113	BLS-CK-2805		199	IN2400		287	ININF		261
7656-13		175	ADKTS01		113	BLS-F		196	IN2400		291	ININF		265
7657-10		175	AG-A		21	BLS-G		196	IN2400		295	ININF		269
7658-10		175	AG-A		25	BLS-T		197	IN2400		332	ININF		281
7659-00		175	AG-A		29	CDH		106	IN3000		287	ININF		287
7PR3700-C		237	AGL20-G		21	CDL		106	IN3000		291	ININF		291
7PR3700-C		243	AGL20-T		21	CDT		106	IN3000		295	ININF		295
7PR3700-C		261	AGL20-TE		21	CDZ		106	IN600		261	ININF		308
7PR3700-C		265	AGL20-X		21	GFL20-L		21	IN600		265	INMIC		237
7PR3700-C		269	AGL201135KC		21	IN-KIT-FUSE10A		237	IN600		269	INMIC		243
7PR3700-C		281	AGL201510KC		21	IN-KIT-FUSE10A		243	IN600		332	INMIC		261
7PR3700-C		287	AGL20760KC		21	IN-KIT-FUSE10A		261	IN6002		237	INMIC		265
7PR3700-C		291	AGS-TR		30	IN-KIT-FUSE10A		265	IN6002		243	INMIC		269
7PR3700-C		295	AMS-TR		30	IN-KIT-FUSE10A		269	INHP/P/1000		237	INMIC		281
7PR3700-C		332	AMS20-G		29	IN-KIT-FUSE10A		281	INHP/P/1000		243	INMIC		287
7PR3701		237	AMS20-L		29	IN-KIT-FUSE10A		287	INHP/P/1000		261	INMIC		291
7PR3701		243	AMS20-T		29	IN-KIT-FUSE10A		291	INHP/P/1000		265	INMIC		295
7PR3701		261	AMS20-TE		29	IN-KIT-FUSE10A		295	INHP/P/1000		269	INMIC		308
7PR3701		265	AMS20-X		29	IN-KIT-TAP		237	INHP/P/1000		287	INSF1		237
7PR3701		269	AMS201135KC		29	IN-KIT-TAP		243	INHP/P/1000		291	INSF1		243
7PR3701		281	AMS201510KC		29	IN-KIT-TAP		261	INHP/P/1000		295	INSF1		261
7PR3701		287	AMS20760KC		29	IN-KIT-TAP		265	INHP/P/1000		332	INSF1		265
7PR3701		291	ASS-TR		30	IN-KIT-TAP		269	INHP/P/300		237	INSF1		269
7PR3701		295	ASS20-G		25	IN-KIT-TAP		281	INHP/P/300		243	INSF1		281
7PR3701		332	ASS20-L		25	IN-KIT-TAP		287	INHP/P/300		261	INSF1		287
7PR3702-V		237	ASS20-T		25	IN-KIT-TAP		291	INHP/P/300		265	INSF1		291
7PR3702-V		243	ASS20-TE		25	IN-KIT-TAP		295	INHP/P/300		269	INSF1		295
7PR3702-V		261	ASS20-X		25	IN-KIT-TAP		332	INHP/P/300		287	INSF1		307
7PR3702-V		265	ASS201135KC		25	IN-MOL-AV		237	INHP/P/300		291	INSF2		237
7PR3702-V		269	ASS201510KC		25	IN-MOL-AV		243	INHP/P/300		295	INSF2		243
7PR3702-V		281	ASS20760KC		25	IN-MOL-AV		261	INHP/P/300		332	INSF2		261



<b>Codice   Code</b>	<b>p.</b>
INSF2	<b>265</b>
INSF2	<b>269</b>
INSF2	<b>281</b>
INSF2	<b>287</b>
INSF2	<b>291</b>
INSF2	<b>295</b>
INSF2	<b>307</b>
KT 10410	<b>32</b>
KT 10410	<b>52</b>
KT 10420	<b>32</b>
KT 10420	<b>52</b>
KT 10440	<b>32</b>
KT 10440	<b>52</b>
KT10206	<b>32</b>
KT10206	<b>52</b>
KT10206/D	<b>33</b>
KT10206/D	<b>53</b>
KT10411	<b>33</b>
KT10411	<b>53</b>
KT10411	<b>197</b>
KT10440	<b>113</b>
KT10441	<b>33</b>
KT10441	<b>53</b>
TLC1	<b>111</b>
TLC2	<b>111</b>
TLC3	<b>111</b>
TLC3	<b>113</b>
TLC4	<b>111</b>

**1. PREMESSE**

Le forniture comprendono solo quanto espressamente specificato nella conferma di accettazione dell'ordine della ditta Venditrice e sono regolate dalle presenti condizioni generali, salvo deroghe risultanti da esplicito accordo scritto. Eventuali variazioni o comunicazioni durante il corso della fornitura non costituiscono invalidazione del contratto. I termini di consegna convenuti hanno valore indicativo e non tassativo. In qualunque momento l'esecuzione della fornitura potrà essere sospesa in caso di mutamento nelle condizioni patrimoniali del Committente ai sensi dell'Art. 1461 del Codice Civile.

**2. PREZZI**

I prezzi si intendono Franco Fabbrica della ditta Venditrice. Essi non comprendono prestazioni ed oneri non menzionati. Gli imballaggi sono inclusi nel prezzo, salvo diversa patenzione scritta.

**3. VARIABILITA' PREZZI**

I prezzi indicati nel contratto sono stati calcolati in base ai costi dei materiali e della manodopera alla data del contratto stesso, in base alle relative tabelle dell'ANIE. Il sistema di calcolo delle variazioni di qualsiasi entità in più o in meno, che dovessero verificarsi su detti costi durante il periodo dell'esecuzione della vendita, verrà effettuato in base alle clausole di variabilità prezzi vigenti per apparecchi di illuminazione pubblicato dall'ANIE.

**4. MODALITA' DI PAGAMENTO**

Si riconoscono solo i pagamenti fatti direttamente al nostro domicilio o a persone da noi autorizzate.

**5. RISERVA DI PROPRIETA'**

La ditta Venditrice conserva la proprietà sui materiali fino a totale pagamento di essi, ma i rischi sono assunti dal compratore sin dalla consegna. Qualunque atto del Committente che, salvo esplicito consenso scritto della Ditta Venditrice, involga pregiudizio al diritto della Ditta Venditrice alla rivendita del materiale, sarà sottoposto alle sanzioni di legge.

**6. CONSEGNA**

Il termine di consegna indicato non impegna la Ditta Venditrice, la quale non è tenuta a corrispondere indennizzi di sorta per eventuali danni diretti ed indiretti dovuti a ritardi di consegna o ad interruzione od a risoluzione parziale o totale della fornitura. Il termine di consegna decorre dalla data della conferma d'ordine e in ogni caso non ha inizio prima del ricevimento della rata di pagamento all'ordine quando essa sia stata concordata. Esso si intende di diritto adeguatamente prorogato se i pagamenti non vengono effettuati puntualmente, se il Committente manca di fornire in tempo utile quanto stabilito nel contratto o se comunque insorgano cause indipendenti dalla Ditta Venditrice, ivi compresi eventuali ritardi di subfornitori.

**7. RESO MERCE**

La merce può essere resa esclusivamente previa autorizzazione della Ditta Venditrice e con un deprezzamento minimo del 30%

**8. TRASPORTO**

La merce viaggia rischio e pericolo del Committente comprese le eventuali rotture anche se spedita in porto franco. Trascorsi 8 giorni dal ricevimento non si accettano reclami. Gli ordini saranno evasi secondo la disponibilità e le spedizioni potranno essere fatte anche parzialmente.

**9. DATI TECNICI**

I materiali forniti, salvo diverse particolari prescrizioni da concordarsi per iscritto, corrispondono alle vigenti norme del CEI - Comitato Elettrotecnico Italiano, ove queste siano applicabili. La ditta Venditrice si riserva di apportare in qualunque momento ai propri prodotti quelle modifiche che ritenesse tecnicamente convenienti. I disegni dalle Ditta Venditrice sono di sua proprietà e non possono dal Committente essere consegnati a terzi né prodotti senza autorizzazione scritta.

**10. GARANZIA**

Ideallux garantisce i suoi prodotti per 24 mesi dalla data di fabbricazione indicata sul prodotto. La garanzia copre tutti i difetti di fabbricazione siano essi di natura meccanica o elettronica. Non sono inclusi in garanzia tutti i danni causati dalla movimentazione e/o utilizzo errato e non conforme a quanto riportato sulle istruzioni d'uso. La garanzia decade nel caso in cui i prodotti vengano manomessi e/o modificati.

Il prodotto difettoso per cui è richiesto l'intervento in garanzia, può essere riparato o sostituito con un articolo complementare sia nuovo che ricondizionato ad insindacabile giudizio di Ideallux. I prodotti che riportano il marchio "5 years warranty" sono coperti da 5 anni di garanzia considerando 14h/giorno per 365 giorni solari annuali, nel rispetto del lifetime indicato sulla scheda prodotto. I reclami per interventi in garanzia entro i 5 anni dalla data di fabbricazione (ad esclusione di quelli ricevuti entro i termini legislativi sopra indicati) saranno soggetti ad approvazione di Ideallux. Guasti che rientrano nella difettosità fisiologica dichiarata e comunque entro il 5% del totale degli articoli installati non sono coperti dalla garanzia 5 anni. Termini e condizioni generali di garanzia sono disponibili e possono essere richiesti presso la sede Ideallux.

**11. CONTROVERSIE**

I contratti, anche se stipulati con cittadini esteri o per materiali forniti all'estero, sono regolati dalla vigente legislatura italiana. Foro competente è soltanto quello avente giurisdizione nella sede legale della Ditta Venditrice anche in deroga agli art. 32 e seguenti del Codice di Procedura Civile, esclusa per il Committente la possibilità di adire l'Autorità Giudiziaria di altro luogo anche in via di garanzia o di connessione di causa, ma salva la facoltà alla Ditta Venditrice di esperire, in qualità di attrice, un'azione nel luogo di residenza, in Italia o all'estero, del Committente. Le eventuali contestazioni non dispensano il Committente dall'osservare le condizioni di pagamento pattuite e non implicano alcun prolungamento dei termini convenuti. Le spese di contratto, la sua registrazione e l'eventuale trascrizione sono a carico del Committente.

**1. INTRODUCTION**

The supplies include only what is expressly specified in the order acceptance confirmation of the Vending Company and are governed by these general conditions, save for provisions resulting from an explicit written agreement. Any changes or notifications during the supply do not constitute the invalidation of the contract. The agreed delivery terms are merely indicative and are not binding. The execution of the supply may be suspended at any time due to changes to the financial conditions of the Buyer in accordance with the Art. 1461 of the Italian Civil Code.

**2. PRICES**

The prices are Ex-works of the Vending Company and do not include services at charges that have not been mentioned. The packages are included in price. The package cannot be returned, save for a different written agreement.

**3. CHANGES IN PRICES**

The prices shown in the contract were calculated based on the costs of the materials and of the labor on the date of the contract based on the related ANIE tables. The calculation system of any kind of changes, whether more or less, that may arise to said costs during the period of execution of the sale will be carried out based on the clauses of the changes of prices in force for lighting equipment published by ANIE.

**4. PAYMENT**

We recognize as valid payment only the ones made directly to our address or to our authorized people.

**5. RETENTION OF TITLE**

The Vending Company keeps the ownership of materials until paid in full, but the risks are assumed by the Buyer upon delivery. Any action of the Buyer, that results in prejudice to the right of the Vending Company to resell the material, will be subjected to legal sanctions, save for the explicit written consent of the Vending Company.

**6. DELIVERY**

The delivery period shows does not bind the Vending Company, which is not bound to pay indemnities arising for any direct or indirect damage due to delivery delays, downtime or the partial or total return of the supply. The delivery period is effective from the date of the order confirmation and in any case does not begin prior to having received the payment instalment for the agreed amount. This term is adequately extended by right if the payments are not made punctually, if the Buyer fails to supply what is set out in the contract in useful time or if causes nonetheless arise regardless of the Vending Company, therein including any delays of sub-contractors.

**7. RETURN OF GOODS**

The goods may only be returned upon the authorization of the Vending Company and with a depreciation of 30%.

**8. TRANSPORT**

The goods travel at Customer's risks and danger, even in case of damage in fall of delivery terms Free destination.

**9. TECHNICAL DATA**

Save for special prescriptions to be agreed in writing, the materials supplied correspond to the standards in force of the CEI (Italian Electrical and Technical Council), where applicable. The Vending Company reserves the right to change its products at any time where deemed technically convenient. The designs of the Vending Company are its own property and may not be given by the Buyer to third parties without written authorization.

**10. WARRANTY**

IDEALLUX guarantees its products for 24 months from the date of production indicated on the item. The warranty covers all manufacturing defects whether they are of a mechanical or electronic nature. All damage caused by handling and / or incorrect use, or use not in accordance with the instructions indicated in the operating instructions are not covered by this warranty. The warranty will expire if the products are tampered with and/or modified. The defective product requiring warranty intervention can be repaired or replaced with a similar article both new and reconditioned at the discretion of Ideallux. The products with mark "5 years warranty" are covered by 5 years warranty considering 14 h/day for 365 solar annual days, respecting the lifetime indicated in the product data sheet. Claims for warranty work within 5 years from the date of manufacture (except those received within the above mentioned legislative terms) will be subject to Ideallux approval.

Faults that fall within the declared physiological defect and in any case within 5% of the total installed items will not be covered by the 5 years warranty. Warranty general terms and conditions are available and can be requested at Ideallux offices.

**11. DISPUTES**

Even if stipulated with foreign citizens or for materials supplied abroad, the contracts are governed by the Italian legislation in force. The only competent court is the one having jurisdiction in the registered office of the Vending Company, also in provision of Art. 32 and ff. of the Italian Code of Civil Procedure, apart from the Buyer's possibility of applying to the Judicial Authority of another place also as a guarantee or related cause, but save for the right of the Vending Company to carry out an action in the place of residence of the Buyer in Italy or abroad as the plaintiff. Any disputes do not waive the Buyer from observing the agreed payment conditions and do not imply any extension of the agreed terms. The costs of the contract, its registration and transcription are at the expense of the Buyer.

Graphics&Creativity

Purplecloud design | William Cardani



Contents

Ufficio tecnico | Ideallux®

LithoPrinter

Reggiani Arti grafiche

Le informazioni e le caratteristiche tecniche possono essere soggette a variazioni senza preavviso. Ideallux® si riserva in qualsiasi momento, a suo giudizio e senza preavviso, di apportare modifiche ai prodotti inseriti nel proprio catalogo. I dati tecnici contenuti nel catalogo sono da considerarsi validi salvo errori e/o omissioni. La riproduzione del materiale contenuto nel presente catalogo è vietata senza il consenso scritto da parte di Ideallux®.

*The information and specifications are subject to changes without notice. Ideallux® reserves the right at any time at its discretion and without notice, to make changes to the products included in its catalogue. The technical data in the catalogue are valid except for errors and/or omissions. The reproduction of the material contained in this catalogue is prohibited without the written consent of Ideallux®.*



**IDEALLUX®**

GRUPPO **RAINA**

Via Casinghino, 11  
27024 Cilavegna (PV) | Italy

Tel. +39 0381 969814  
Fax +39 0381 669709

[grupporaina@ideallux.it](mailto:grupporaina@ideallux.it)  
[www.grupporaina.it](http://www.grupporaina.it)